



€

GÖTESSONS

FROM WORKPLACE TO CREATIVE SPACE™ 2024

NEW INSPIRING WALLPANELS



SLICEPANEL / PLANTPANEL SLICE

SlicePanel and PlantPanel Slice are two wall decorations in molded felt. One that is adapted for plants and one without the ability to add plants. The wavy pattern creates a cool visual effect and we recommend you to combine the two models. The plants come without a pot where the stem is placed in the pre-punched holes.

Read more on pages 104 and 148.

LEAFPANEL

LeafPanel is a wall decoration made of molded felt that gives you the association of nature and cut-out leaves. When placed on the walls, LeafPanel becomes a highly impactful decoration in the room while also providing a good sound absorption effect. Choose between lively colors or get a more neutral look that blends into the wall.

Read more on pages 104 and 149.





THE NATURAL WORKPLACE

Research shows that natural materials, daylight, and access to greenery promote well-being, health, and creativity.

Isabelle Sjövall, who has written the foreword to our latest inspiration magazine, is a neurodesigner, researcher and author of the books Neurodesign and Designfulness.

In her books, Isabelle has investigated and described why we experience well-being in our surroundings. Certainly, there is no simple answer, but much can be linked to our primitive brain. Throughout human history, the world around us has changed rapidly, but the brain has not quite kept pace. The environment we live in is characterized by modern technology, speed, and a process-oriented mindset, creating stress and hindering our creativity. The positive aspect is that with the right knowledge, we can help our brains focus. By using science in the planning, shaping, and construction of our environment, we have good chances of improving health and well-being.

Doesn't this sound interesting? Visit our website and read the magazine now. Welcome to be inspired!

2024

INDEX

Intro and Inspirational news	2-5
Textiles, Zips, Seams, Mounts	6-25
Desk screens, Desk screen booths	26-39
Toolbars, Rails, Screen accessories	40-49
Floor screens, Room dividers	50-57
Room-within-a-room	58-69
Whiteboards, Writing boards, Notice boards	70-81
Absorbents ceilings	82-101
Absorbents wall	102-115
Storage	116-123
Soft seating, Table	124-139
Ergonomic products, Floor protection	140-145
Plants, Pots, Baskets	146-167
Lighting	168-177
Monitor arms	178-183
Recycling, CPU holders, Cable holders, Cable collectors	184-199
Electrical accessories	200-211
Product register, Information, Delivery time	212-213

SIT EXTRA COMFORTABLE



ROMBOBACKREST

With this custom-made cushion, you sit extra comfortable in the Rombo-Seat furniture. Shaped to provide support and relief for the back. Match with colours from the chair's other textiles or order in a unique colour.

See price and more on page 131.



POWERPORT

A stylish and practical electrical outlet that can be used in a variety of environments. Powerport is spring-loaded and opens with a simple push. With two led lights on the sides that you turn on by a touch button in open position. Holding down the button changes the brightness. Dimming with memory function. With USB-A, USB-C and two power outlets.

See more on page 202.

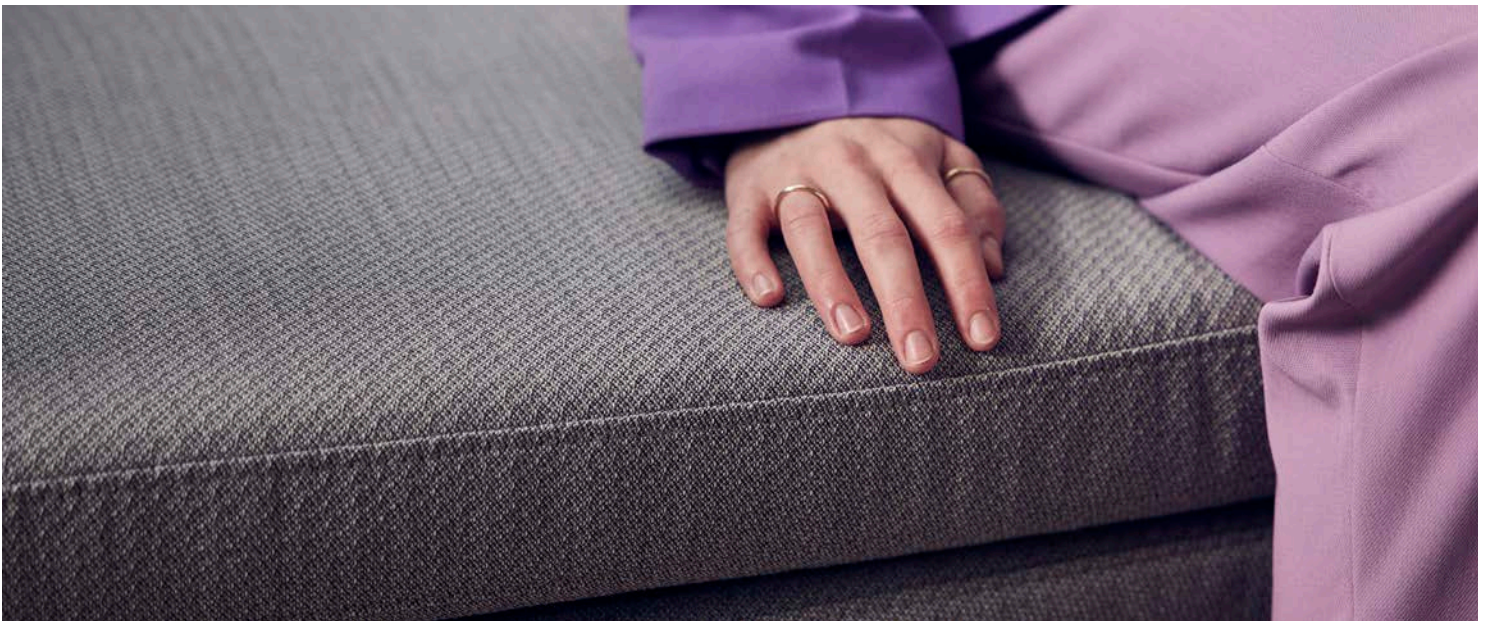

ALLEY

A Scandinavian design language, a fantastic natural material and solid craftsmanship sum up the furniture fabric Alley. It's made from wool of Norwegian sheep, which give the textile its significant look. The wide range of colours are dominated by natural tones that have been carefully chosen to bring out the wool's natural variations. The fabric is yarn-dyed, which allows the interplay of colours to form a pleasant pattern.

See more on page 13.



TEXTILE WITH
MOCCA CHARACTERISTICS

NOBLE LUX

Noble Lux holds an exciting expression all while maintaining an elegant simplicity. The surface made of 100% polyester has suede qualities, leaving a nuance change on the fabric when touched. With a simple swipe in the opposite direction, the nuance is "painted" over again. The textile's marble effect makes each piece of furniture unique.

See more on page 10.



Textile suitable for screens and panels



Textile suitable for soft seating

Price class
1

TONAL BY GABRIEL

Post-consumer Recycled

TONAL-A CROSSFUNCTIONAL TEXTILE WITH AN EXCELLENT ENVIRONMENTAL PROFILE

With its discreet yet distinct look, good performance and excellent environmental profile, Tonal is a highly usable cross functional textile that is suitable for a variety of applications and interiors. Tonal is a two-coloured fabric in a playful yet harmonious melange. The fusion of Light and Dark tones adds depth and creates an almost three-dimensional effect. Tonals colour palette offers a mix of cold and warm colours, deep and bright hues.



Colour 120
(2495-60122
Light Grey)



Colour 121
(2495-60123
Light Grey)



Colour 122
(2495-64211
Dark Red)

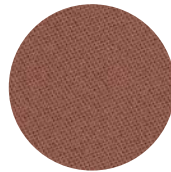

Colour 123
(2495-64210
Light Red)

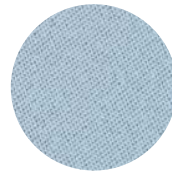

Colour 124
(2495-66184
Light Blue)

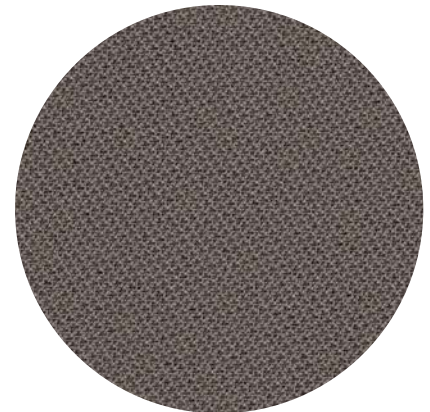

Colour 130
(2495-61182
Red Brown)

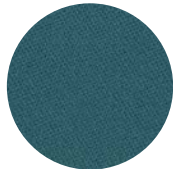

Colour 125
(2495-66186
Dark Blue)

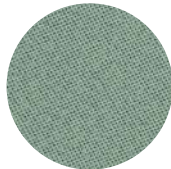

Colour 126
(2495-67089
Light Green turquoise)

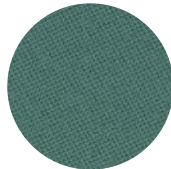

Colour 127
(2495-67090
Green Turquoise)

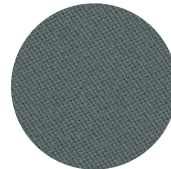

Colour 128
(2495-60124
Grey)

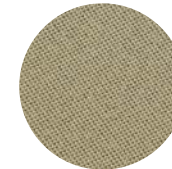

Colour 129
(2495-61179
Light Beige)

Price class
1

EVENT SCREEN + BY GABRIEL

EVENT SCREEN + – A VERSATILE, CROSS-FUNCTIONAL TEXTILE

Event Screen + is a versatile, cross-functional upholstery fabric made of 100% polyester. With its crispy look, distinct stony texture and fresh colour palette, Event Screen + is a confident and modern interpretation of the classic crepe fabric. Event Screen + fulfills the requirements for both vertical and horizontal surfaces, making it suitable for both screens and soft seating. Event screen+ matches perfectly with Mica, together the two fabrics offer an intriguing array of coordinated colour options.



Colour 01
(60000 White)



Colour 02
(61008 Light Beige)

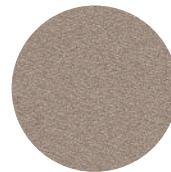

Colour 03
(61011 Light Brown)

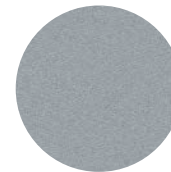

Colour 04
(60004 Light Grey)

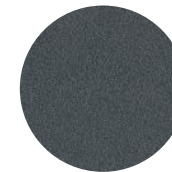

Colour 06
(60021 Dark Grey)



Colour 05
(60002 Light Grey)



Colour 07
(60999 Black)

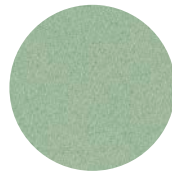

Colour 08
(67015 Light Green)

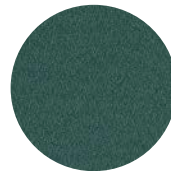

Colour 09
(67017 Dark Green)

Price class
1

MICA BY GABRIEL

Post-consumer Recycled

MICA – SOPHISTICATED WITH A FOCUS ON SUSTAINABILITY

Mica is a cross functional, two-toned crêpe fabric. It is highly suitable not only for furniture but also for panels and screens. Made of 97% post-consumer recycled polyester, Eu-ecolable and Oekotex certified Mica is the excellent sustainable alternative.

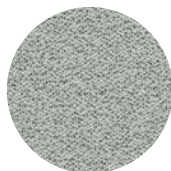

Colour 100
(2500 60000 Light White)

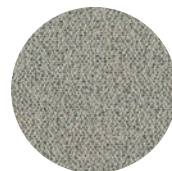

Colour 101
(2500 61008 Light Beige)



Colour 102
(2500 61011 Light Brown)

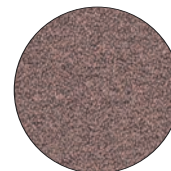

Colour 103
(2501 64183 Light Red)

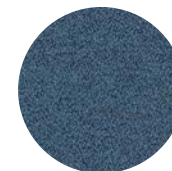

Colour 104
(2501 66030 Blue)



Colour 108
(2501 67015 Light Green)

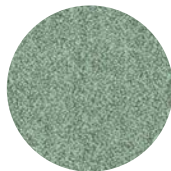

Colour 105
(2500 67015 Light Green)

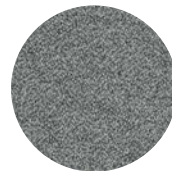

Colour 106
(2501 60000 Dark White)

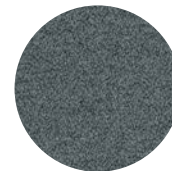

Colour 107
(2501 60002 Grey)



Price class
1

CARLOW BY CAMIRA

CARLOW – BRAVE AND CALM

Carlow is a screen textile made of 100% polypropylene. Carlow brings fascinating new colour blends which can be teamed with many other fabrics, and it is perfectly matched with the screen partner Cara. With its acoustically transparent properties the fabric helps maintain interior serenity, easy on both the eye and the ear.



Colour 220
(Convoy CLW09)

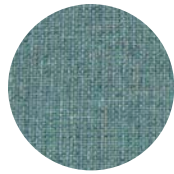

Colour 221
(Cavan CLW15)

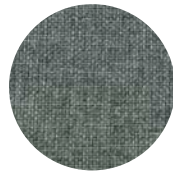

Colour 222
(Parteen CLW23)

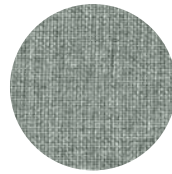

Colour 223
(Tallow CLW01)

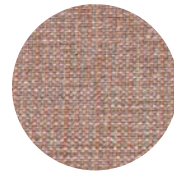

Colour 224
(Callan CLW05)

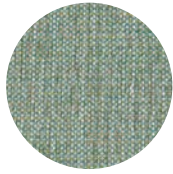

Colour 225
(Carrick CLW18)

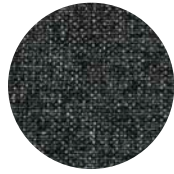

Colour 226
(Avoca CLW22)

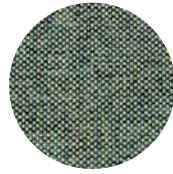

Colour 227
(Emly CLW21)



Colour 228
(Quin CLW04)

Price class
1

OMEGA BY AUDEJAS

OMEGA – RUSTIC STRUCTURE AND EARTHY NUANCES.

Omega is a multifunctional textile made of 100% polyester. With its distinct and somewhat coarser structure, the textile becomes a timeless and stylish element in any type of environment. Through its classic and dampened expression, soft texture and earthy palette, Omega dresses both furniture and screens well.

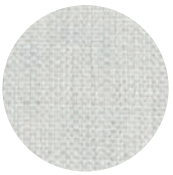

Colour 465
(1/18)

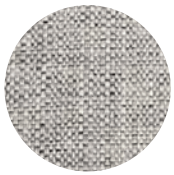

Colour 466
(1/16)

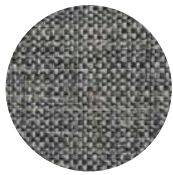

Colour 467
(1/1)

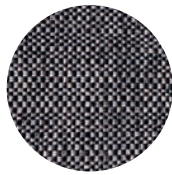

Colour 468
(1/12)

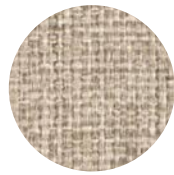

Colour 469
(1/31)



Colour 470
(1/33)



Colour 471
(1/81)



Colour 472
(1/36)



Colour 473
(1/30)

Price class
1

SLOPE BY NEVOTEX

SLOPE – MELANGE AND STRUCTURE

Slope can be used for both screens and soft seating. The textile is made of 100% polyester and the earthy colours are soft and pleasant. Combined with the fabric structure and melange expression Slope gives a unique touch to any furniture it upholsters.



Colour 250
(17 Sand)



Colour 251
(18 Lemongrass)



Colour 252
(36 Orchid)

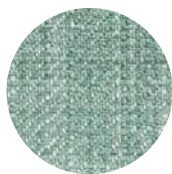

Colour 253
(33 Crystal)

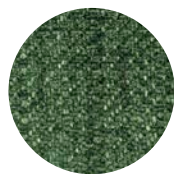

Colour 254
(34 Bottle Green)

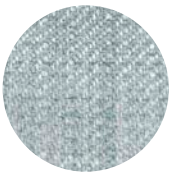

Colour 255
(20 Ice Blue)

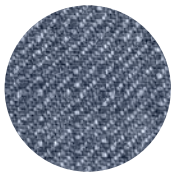

Colour 256
(22 Ocean)



Colour 257
(06 Silver)

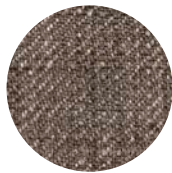

Colour 259
(13 Mole)

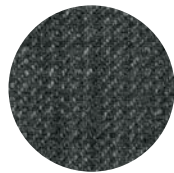

Colour 260
(08 Stone)

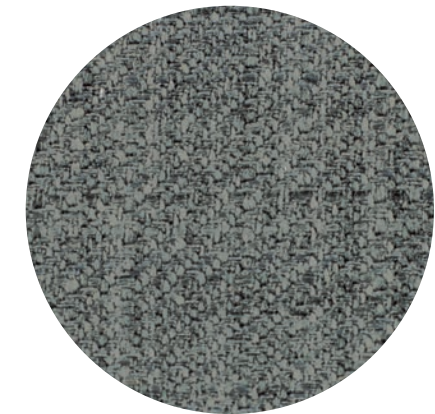

Colour 258
(07 Steel)

Price class

1

PEARL BY NEVOTEX

PEARL – AN EFFECTFUL FABRIC WITH CLASS

Pearl with its strong technical qualities and modern design, creates a beautiful and striking impression on both screens and soft seating. Earthy tones and a beautiful glow that sometimes gives the visual feeling of metal are both found in the textile's wide colour range.



Colour 335
(00A9 Creme)



Colour 336
(0019 Linen)

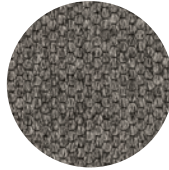

Colour 337
(00G3 Stone)



Colour 338
(00Q6 Java)

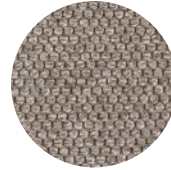

Colour 339
(0037 Beige)



Colour 343
(00S6 Rust)



Colour 340
(0073 Taupe)



Colour 341
(0098 Amber)

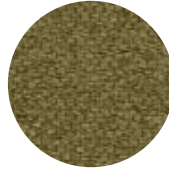

Colour 342
(00Y8 Oregano)

Price class

1

HUSH BY GABRIEL

HUSH – DISCRETE ELEGANCE

Hush is the perfect textile for screens thanks to its ability to blend in with other furniture with its sophisticated melange effect, all while giving a welcoming impression. Hush is made of a polyester and viscose blend. A mix between White and coloured fibers creates the fabrics soft colours structure, which softens rooms and gives them style and personality.

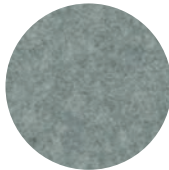

Colour 560
(60155 Grey)

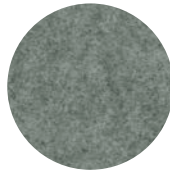

Colour 561
(60158 Grey)

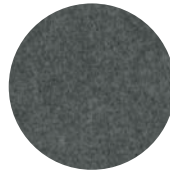

Colour 562
(60159 Grey)

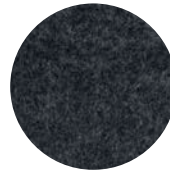

Colour 563
(60900 Black)

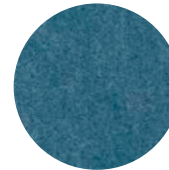

Colour 567
(67046 Blue)

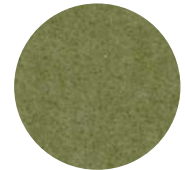

Colour 569
(68103 Forest Green)

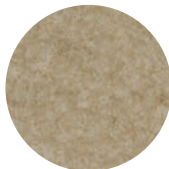

Colour 570
(61174 Light Brown)

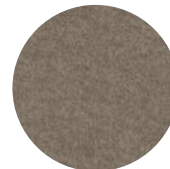

Colour 571
(61225 Beige)



Colour 572
(64148 Light Red)

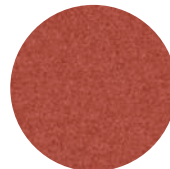

Colour 573
(63058 Red)

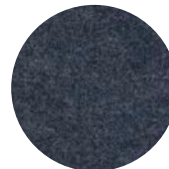

Colour 574
(66133 Dark Blue)



Colour 568
(68102 Yellow)



Colour 584
(68159 Green)

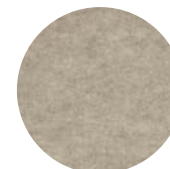

Colour 587
(61226 Light Beige)

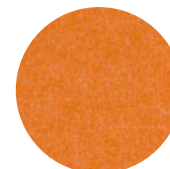

Colour 581
(63083 Orange)

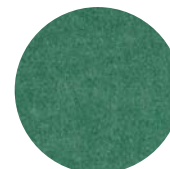

Colour 579
(67048 Turquoise)

Price class

1

XPRESS BY GABRIEL

XPRESS – NATURAL DECORATION

Xpress is made of 100% polyester and its wide spectrum of colours makes it a much appreciated screen fabric. With its multicoloured structure and delicate matte surface, the nature seems to work itself into the decor with Xpress. It is optimal for minimalistic as well as colourful decoration in both private and public interiors.



Colour 540
(60162 Light Beige)

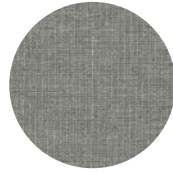

Colour 541
(60003 Light Grey)

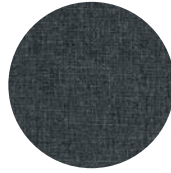

Colour 542
(60004 Grey)

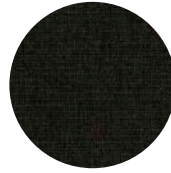

Colour 543
(60999 Black)

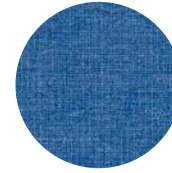

Colour 545
(66009 Blue)



Colour 544
(61183 Beige)

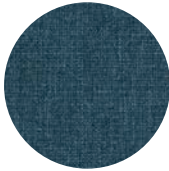

Colour 546
(66010 Dark Blue)

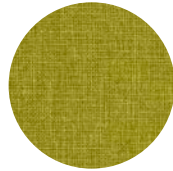

Colour 547
(68002 Green)

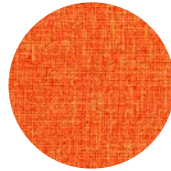

Colour 548
(63013 orange)

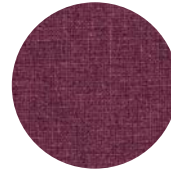

Colour 549
(65081 purple)

Price class

1

CARA BY CAMIRA

CARA – A COLOURFUL VERTICAL SCREEN TEXTILE

Cara is a classic screen textile made of 100% polypropylene, available in a wide assortment of colours. The surface creates a cosy and stylish feeling in all kind of environments. This textile is largely acoustically transparent and therefore an excellent decorative choice for sound absorbing screens.



Colour 370
(Spray EJ033)

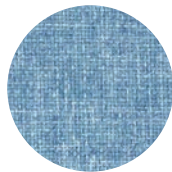

Colour 371
(Dolphin EJ105)

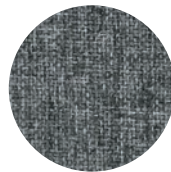

Colour 372
(Lead EJ104)

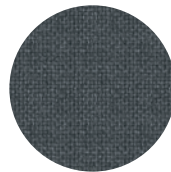

Colour 373
(Merrick EJ048)

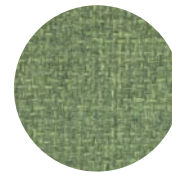

Colour 374
(Fair Isle EJ186)



Colour 378
(Lewick EJ194)

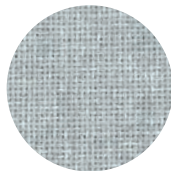

Colour 375
(Glass EJ004)

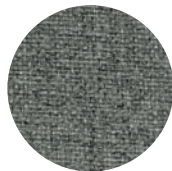

Colour 376
(Portland EJ016)



Colour 377
(Lomond EJ192)



Colour 379
(Maree EJ195)

Price class
2

KAIMAN BY TYGGROSSISTEN

KAIMAN – DURABLE AND MODERN

Kaiman is an artificial high quality vegan leather. The surface is made of 100% polyurethane, a strong and durable material. The surface finish makes it easy to wipe, making it suitable for upholstered furniture.



Colour 390
(780 Black)



Colour 391
(45 Grey)



Colour 392
(120 Light Grey)



Colour 393
(42 Attic)



Colour 394
(430 Dark Green)



Colour 398
(845 Loud Red)



Colour 395
(374 Melba)



Colour 396
(710 Taupe)



Colour 397
(09 Blue)

Price class
2

NOBLE LUX BY TYGGROSSISTEN

NOBLE LUX – SIMPLICITY WITH AN EXCITING EXPRESSION

Noble Lux holds an exciting expression all while maintaining an elegant simplicity. The surface made of 100% polyester has suede qualities, leaving a nuance change on the fabric when touched. With a simple swipe in the opposite direction, the nuance is "painted" over again. The textile's marble effect makes each piece of furniture unique.



Colour 350
(608 Light Beige)



Colour 351
(46 Anthracite)

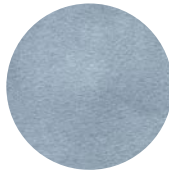

Colour 352
(5005 Baby Blue)

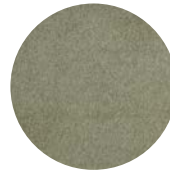

Colour 353
(735 Reed)



Colour 360
(846 Bright Pink)



Colour 354
(165 Nougat)



Colour 355
(709 Argent)



Colour 356
(429 Green)



Colour 357
(50 Orange)



Colour 358
(32 Red)

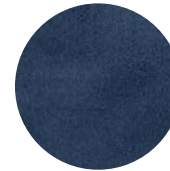

Colour 359
(09 Blue)



Price class
2

LIDO BY NEVOTEX

LIDO – A SOFT AND VERSATILE TEXTILE

Lido is a popular upholstery textile made of 100% polyester. Its strong technical properties and high quality makes the fabric an excellent choice for both screens and soft seating. With its broad colour scale, Lido is a great fit for modern interiors and gives the whole room a lift.

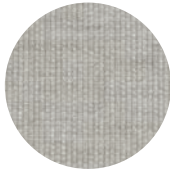

Colour 200
(132 Toned)

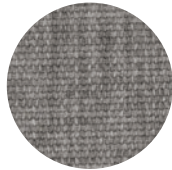

Colour 201
(17 Concrete)



Colour 203
(71 Plum)

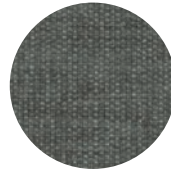

Colour 204
(129 Savile Grey)

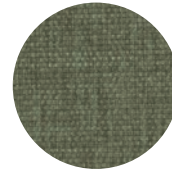

Colour 205
(134 Antique Green)



Colour 202
(148 Orchid)

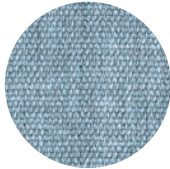

Colour 206
(103 Sky)



Colour 207
(136 Power Blue)



Colour 208
(154 Mustard)

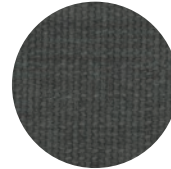

Colour 209
(7 Grafit)

Price class
2

HOUSTON REFLECT BY NEVOTEX

HOUSTON REFLECT – QUALITY WITH TEXTURE

Houston Reflect is a popular alternative for both screens and soft seating due to a good combination of quality, texture and colour. The material composition of polyester and viscose gives the textile a beautiful luster. With a very high abrasion resistance, Houston Reflect is suitable for surfaces with high wear, such as public spaces and soft seating.



Colour 421
(1002 sand 16)



Colour 423
(1013 fudge 36)

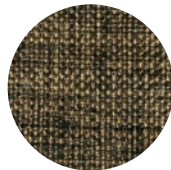

Colour 426
(1036 mosaik 46)

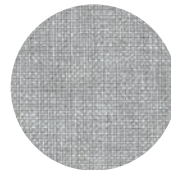

Colour 427
(1011 Silver 17)

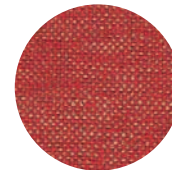

Colour 430
(1040 Red 01)

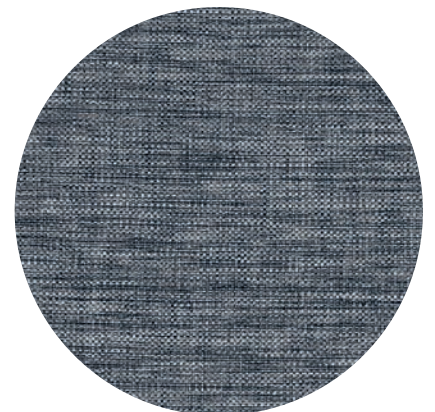

Colour 436
(1053 Greystone)

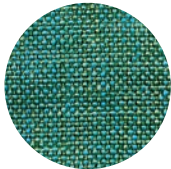

Colour 434
(1027 petrol 22)

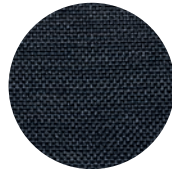

Colour 435
(1038 Black 04)

Price class
2

TWIST BY GABRIEL

TWIST - ELEGANT AND CHARACTERISTIC

Twist is an elegant screen textile woven in the non-flammable yarn Trevira CS. It is highly suitable for use in areas where requirements regarding fire and safety are high. Twist has a beautiful and characteristic structure and at the same time a calm solid colour surface, perfect for most vertical surfaces. With its colour palette and natural surface Twist works great on its own or together with other fabrics.



Colour 440
(60076 Light Grey)

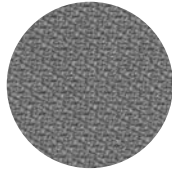

Colour 441
(60011 Medium Grey)



Colour 442
(60021 Dark Grey)

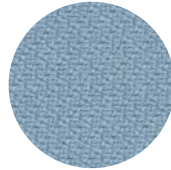

Colour 444
(67004 Greenblue)

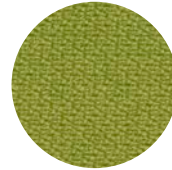

Colour 445
(68119 Yellowgreen)



Colour 447
(60999 Black)



Colour 448
(61104 Beige)

Price class
2

RIVET BY CAMIRA

RIVET - CIRCULAR QUALITY AND AESTHETICS

Rivet is a textile that connects both to the modern workplace and forms a bridge between traditional and modern textiles. Rivet is designed to blend the aesthetic qualities of luxury woolen clothing and modern sportswear and has a Light texture. Rivet is made from 100% recycled polyester from used plastic bottles.

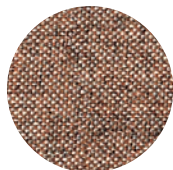

Colour 700
(Molten EGL09)

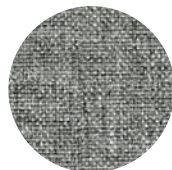

Colour 701
(Vitrous EGL01)

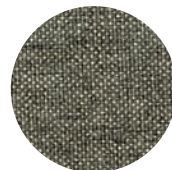

Colour 702
(Cast EGL25)

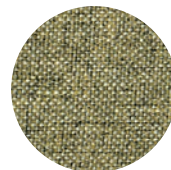

Colour 703
(Alloy EGL05)

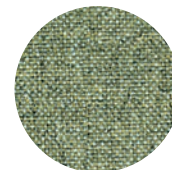

Colour 705
(Burnish EGL11)

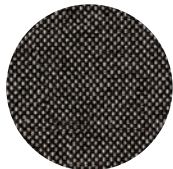

Colour 706
(Charcoal EGL37)

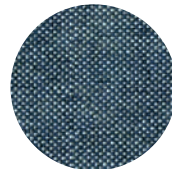

Colour 707
(Hammer EGL27)

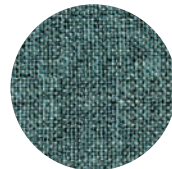

Colour 708
(Verdigris EGL21)

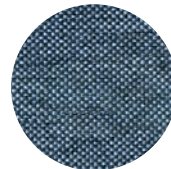

Colour 709
(Crucible EGL24)

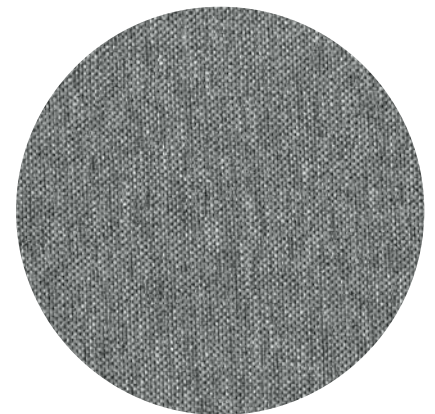

Colour 704
(Galvanise EGL26)

Price class
2

ERA BY CAMIRA

ERA - DISCRETE AND SOPHISTICATED

Era is a subtle, two tone polyester fabric containing stretch in both directions for easy upholstery of furniture. The small herringbone weave gives the textile a discrete modern texture while close up you see how the colouring technique provides a unique and interesting pattern. The palette incorporates playful brights and sophisticated muted tones.

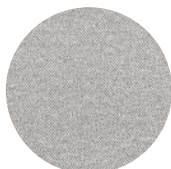

Colour 310
(CSE46 Memo)



Colour 311
(CSE13 Present)



Colour 312
(CSE45 Prompt)



Colour 313
(CSE41 Quota)



Colour 314
(CSE34 Endurance)



Colour 315
(CSE33 Analogue)



Colour 316
(CSE19 Calendar)



Colour 317
(CSE42 Range)

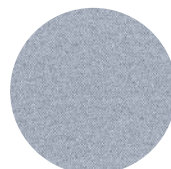

Colour 318
(CSE39 Youth)

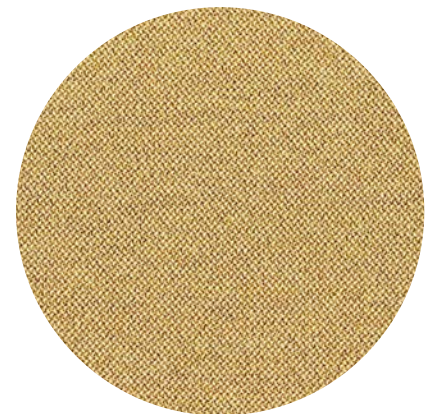

Colour 319
(CSE31 Splitsecond)

Price class
3

ALLY BY LUDVIG SVENSSON

ALLY - THE BEAUTY IN THE CLEAN, UNMADE-UP AND VARIETY

A Scandinavian design language, a fantastic natural material and solid craftsmanship sum up the furniture fabric Ally. It's made from wool of Norwegian sheep, which give the textile its significant look. The wide range of colours are dominated by natural tones that have been carefully chosen to bring out the wool's natural variations. The fabric is yarn-dyed, which allows the interplay of colours to form a pleasant pattern.

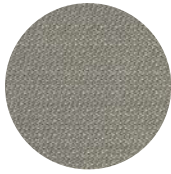

Colour 480
(Ally 6540)

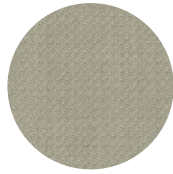

Colour 481
(Ally 6730)

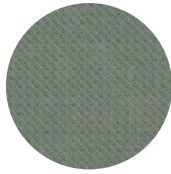

Colour 482
(Ally 5861)



Colour 483
(Ally 5881)

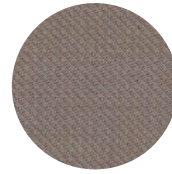

Colour 484
(Ally 3952)



Colour 485
(Ally 8330)

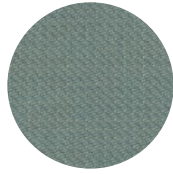

Colour 486
(Ally 5041)

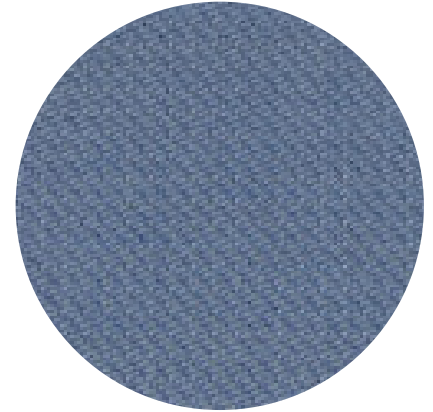

Colour 487
(Ally 4443)

Price class
3

BOND BY GABRIEL *Post-consumer Recycled*

BOND – ADDS CHARACTER TO ALL INTERIORS

Bond is a multifunctional upholstery textile, made of 98% post-consumer recycled polyester and 2% PES. With excellent technical aspects in combination with a natural touch and discrete graphic design, Bond suits all types of furniture and occasions. With a very high abrasion resistance, Bond is a highly durable textile.

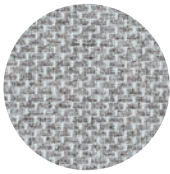

Colour 750
(60094 Light Grey)

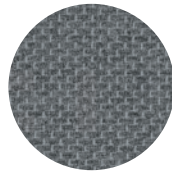

Colour 751
(60096 Grey)

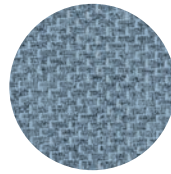

Colour 752
(66157 Light Blue)

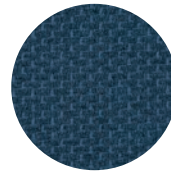

Colour 753
(66159 Dark Blue)

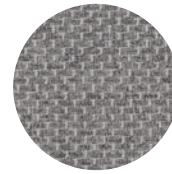

Colour 754
(61158 Light Brown)

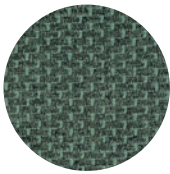

Colour 755
(68176 Green)

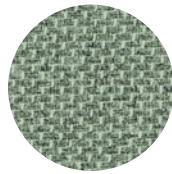

Colour 756
(68175 Light Green)

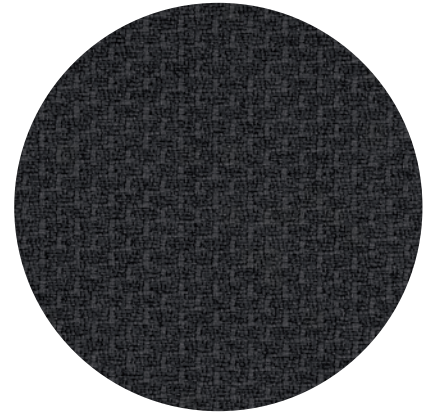

Colour 757
(60097 Dark Grey)

Price class
3

BLAZER BY CAMIRA

BLAZER – VERSATILITY AND QUALITY

Blazer is made of 100% virgin wool from New Zealand, giving it a soft surface that is pleasant for both screens and soft seating. For a broader colour palette with the same feeling, take a look at Synergy.

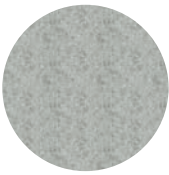

Colour 30
(CUZ28 Silverdale)

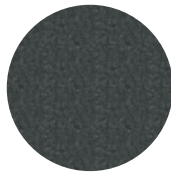

Colour 35
(CUZ30 Silcoats)

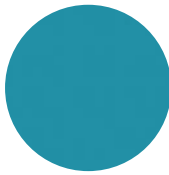

Colour 51
(CUZ02 Aston)

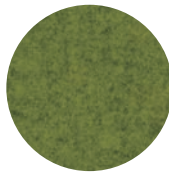

Colour 66
(CUZ1K Camphill)

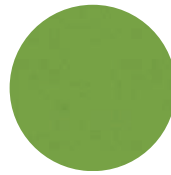

Colour 67
(CUZ1L Newport)



Colour 64
(CUZ86 St Andrews)

Price class
3

BLAZER LITE BY CAMIRA

BLAZER LITE – A FINE VERSION OF BLAZER

Blazer Lite is a finer version Blazer making it lighter in weight for use on desk screens, panels and other vertical surfaces. With a broad palette of melange and single coloured nuances, it's perfect in combination with both Blazer and Synergy.

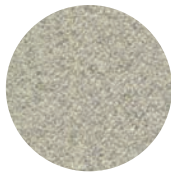

Colour: 800
(Retreat, LTH39)

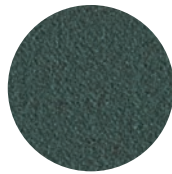

Colour: 801
(Hush, LTH42)

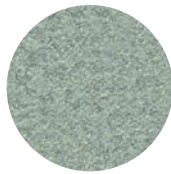

Colour: 802
(Pillow, LTH43)

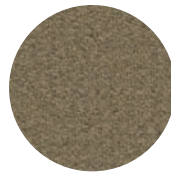

Colour: 803
(Tender, LTH53)

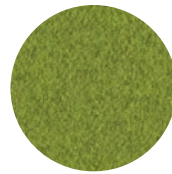

Colour: 804
(Happy, LTH55)



Colour: 809
(Daydream, LTH46)

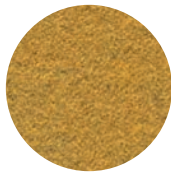

Colour: 805
(Buddha, LTH56)

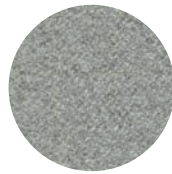

Colour: 806
(True, LTH61)

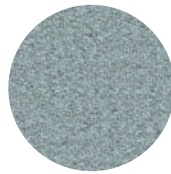

Colour: 807
(Harmony, LTH63)

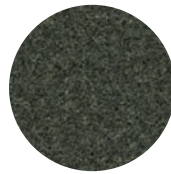

Colour: 808
(Solace, LTH70)

Price class
3

SYNERGY BY CAMIRA

SYNERGY – A FACETED TEXTILE

Synergy is made of 95% virgin wool and 5% polyamid, a composition that gives the fabric a very high abrasion resistance. The textile is soft, strong and Light, while keeping a depth that fascinates. The wool yarn has been carefully woven together with thin nylon, making Synergy a multifunctional textile that suits both soft seating and screens without losing the feel or look of a classic wool fabric.



Colour 620
(Affix LDS 32)



Colour 621
(Affinity LDS 74)

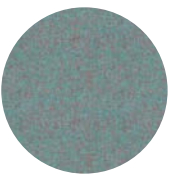

Colour 622
(Kinship LDS 56)



Colour 623
(Support LDS 55)



Colour 624
(Serendipity LDS 08)

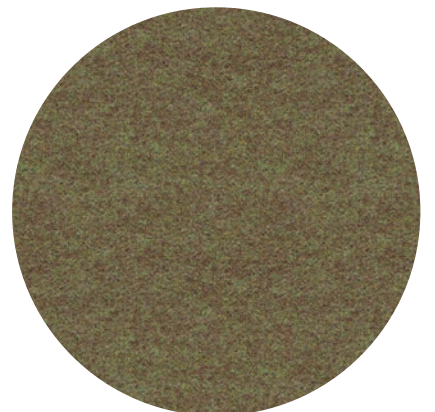

Colour 626
(Interfuse LDS 48)

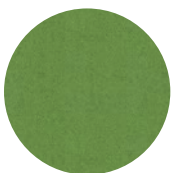

Colour 625
(Integrate LDS 47)

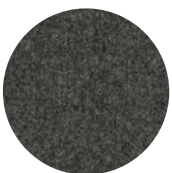

Colour 627
(Mix LDS 17)



Colour 628
(Guild LDS 63)

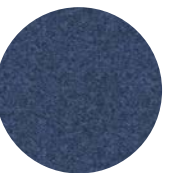

Colour 629
(Alike LDS 62)

Price class
4

REMIX 3 BY KVADRAT

REMIX 3 – QUALITY AND DESIGN IN ONE

Remix is a textile for both screens and soft seating, made of 90% virgin wool and 10% nylon. Wool is an excellent upholstery fabric as it is durable, dirt repellent, comfortable and flame retardant. The textile is designed by the recognized Italian designer Giulio Ridolfo.



Colour 600
(123 Light Grey)



Colour 601
(163 Dark Grey)



Colour 602
(183 Black)

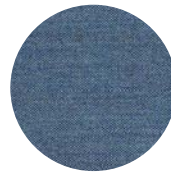

Colour 604
(743 Blue)

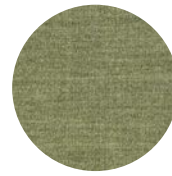

Colour 605
(933 Green)



Colour 606
(682 Lilac)



Colour 607
(982 Dark Green)



Colour 608
(233 Greige)



Colour 603
(223 Beige)

Price class
4

ILLUSION BY NEVOTEX

ILLUSION – ARTIFICIAL LEATHER FOR EASY CLEANING

Illusion is a PU (Polyurethane) artificial leather that can be used in a number of different areas. It fits perfectly with furniture and furnishings of various kinds. Artificial leather can advantageously be used in healthcare environments and other environments where high demands are placed on cleaning.



Colour 281
(Fg 84176 Crepe)



Colour 282
(Trend Fg 44388 Dark camel)



Colour 283
(Fg 48013 Chocolate)



Colour 284
(Fg 00110 Black)

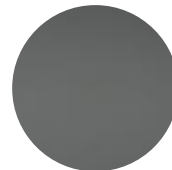

Colour 286
(Trend Fg 57069 Light Grey)



Colour 292
(Fg 68746 Blue)



Colour 293
(Trend Fg 77773 Dark Green)



Colour 296
(Trend Fg 23660 Cherry)



Colour 289
(Fg 58290 Stone)

ACOUSTIC NONWOVEN



Colour: 901
(White Acoustic Nonwoven)



Colour: 902
(Black Acoustic Nonwoven)

With its air-permeable microperforating properties, Acoustic Nonwoven reflects the sound minimally when it hits the surface so that the sound absorber can absorb at maximum. The Acoustic Nonwoven provides a nice smooth surface that can withstand moisture, is odorless, does not rot or mold and does not create any allergies. Acoustic Nonwoven is also used as a barrier between insulation and air gaps, for example when furring stripes are used on walls in sports halls, concert halls, music studios etc. or as a surface layer on sound absorbers and suspended ceiling.

FRAMES

Frames for Collage, Tell-Us, Storyboard and Print.



Colour: 1
(White)



Colour: 2
(Black)

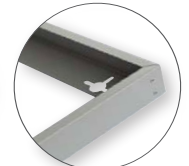

Colour: 3
(Grey)

CORE MATERIAL ECOSUND "RAW"



Colour: 1
(raw White)

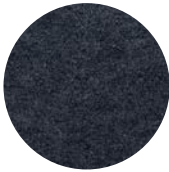

Colour: 2
(raw Black)

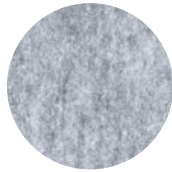

Colour: 3
(raw Grey)

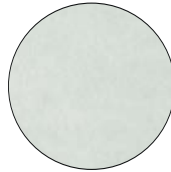

Colour: 6
(raw Light Grey)



EcoSUND is our unique core material for sound absorbent. It's good for both the working environment and our nature. EcoSUND is made of 50% recycled PET and 50% new PET fibres. The fibres EcoSUND is made of are approved according to Oeko-Tex® Standard 100. No emissions, EcoSUND® is completely free from glue/adhesives and therefore it doesn't release any emissions or gases. No dangerous fibres, EcoSUND doesn't release any fibres that itch, irritate or cause allergic reactions.

EXPRESS ORDER

Choose express order and get your screens* produced in 10 working days

*Express order applies when ordering ScreenIT Standard, ScreenIT A30 Desk screen, ScreenIT Flexible and ScreenIT A30 Floor screen in textiles Event Screen+ and Hush. Choose from eight selected colours, four zips or any seam, see images below. Maximum 100 screens/order in standard catalogue version. Placed order can not be changed or cancelled. Mark the order with "Express Order". Screens with straight corners, special screens, deviating hole images, reinforced screens, screens with built in rail and booths are not included in the offer.

EVENT SCREEN +



Colour 03
(61011 Light brown)



Colour 04
(60004 Light Grey)



Colour 06
(60021 Dark Grey)



Colour 07
(60999 Black)

HUSH

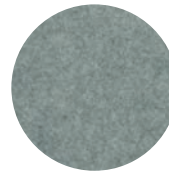

Colour 560
(60155 Grey)

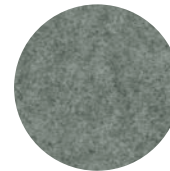

Colour 561
(60158 Grey)

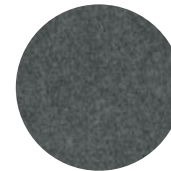

Colour 562
(60159 Grey)

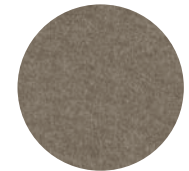

Colour 571
(61225 Beige)

ZIPS/SEAMS



Colour zip: 100, seam: 200 (White)



Colour zip: 101, seam: 201 (Black)



Colour zip: 121 (wine Red)



Colour zip: 106 (Silver)



Colour code seam, see page 17.

HANGERS

Hangers for Effekt EcoSUND Pendant.

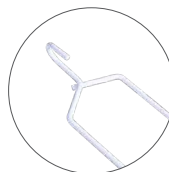

643000-1
(White)

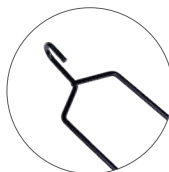

643000-2
(Black)

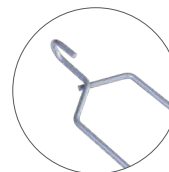

643000-3
(Silver)

ZIPS



Colour zip: 100 (White)



Colour zip: 101 (Black)

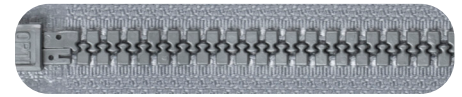

Colour zip: 106 (Silver)



Colour zip: 114 (Off White)

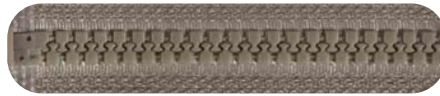

Colour zip: 117 (Aand)



Colour zip: 118 (Hazel Brown)



Colour zip: 119 (Misty Pink)

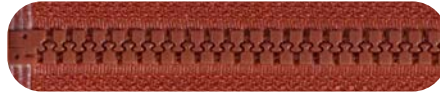

Colour zip: 120 (Rust)



Colour zip: 121 (Wine Red)

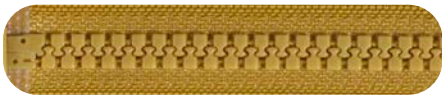

Colour zip: 122 (Mustard Yellow)



Colour zip: 123 (Forest Green)



Colour zip: 124 (Indigo Blue)



Colour zip: 107 (fishbone Black/White)

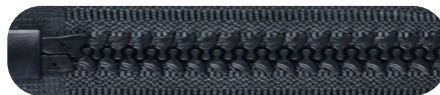

Colour zip: 108 (fishbone Black/Black)



Colour zip: 112 (fishbone White/Black)



Colour zip: 113 (fishbone Silver Grey/Brown)

NOTE!

Colour deviation on our textiles and zippers can occur during printigt. For exact colours, order colour cards from us.

SEAMS



Colour seam: 200 (White)



Colour seam: 201 (Black)



Colour seam: 214 (Off White)



Colour seam: 217 (Sand)



Colour seam: 218 (Hazel Brown)



Colour seam: 219 (Misty Pink)



Colour seam: 220 (Rust)



Colour seam: 221 (Wine Red)



Colour seam: 222 (Mustard)



Colour seam: 223 (Forest Green)



Colour seam: 224 (Indigo Blue)



Colour seam: 206 (seam like textile)



Textile suitable for screens and panels



Textile suitable for soft seating

A set cost is added when ordering outside of the standard textile range. Please contact info@gotessons.se for more information.

Creek can only be chosen to articles on page 17-19.
 Care can be chosen to all articles on page 18-19, except Sandy.
 Illusion works for all our articles.



Price class
2

CARE BY TYGGROSSISTEN

CARE - ARTIFICIAL LEATHER FOR MEDICAL CARE

Care is a PU (Polyurethane) artificial leather that can be used in hospitals/care as well as indoor and outdoor furniture. The surface of the textile is without structure, which makes it easy to clean and it has properties such as oil-resistant, urine-resistant, blood-resistant and alcoholable up to 70% alcohol.



Colour 140
(White)

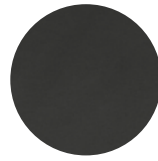

Colour 141
(Black)

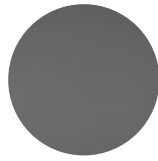

Colour 142
(Light Grey)

CREEK BY VESCOM

CREEK - DURABLE VINYL WITH A TEXTILE LOOK

Creek's irregular melange surface gives it a soft design that reminds one of the appearance of linen fabric as well as having all of the strong, technical qualities that are found in a vinyl. The material can be disinfected with alcohol based detergents, which makes the products excellent choices in the healthcare sector as well as for different school and education environments.



Colour 501
(7053.03)



Colour 506
(7053.13)

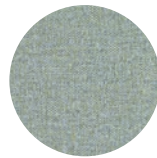

Colour 507
(7053.21)

ILLUSION BY NEVOTEX

ILLUSION - ARTIFICIAL LEATHER FOR EASY CLEANING

Illusion is a PU (Polyurethane) artificial leather that can be used in a number of different areas. It fits perfectly with furniture and furnishings of various kinds. Artificial leather can advantageously be used in healthcare environments and other environments where high demands are placed on cleaning.



Colour 281
(Fg 84176 Crepe)

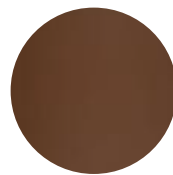

Colour 282
(Trend Fg 44388 Dark camel)



Colour 283
((Fg 48013 Chocolate)



Colour 284
(Fg 00110 Black)

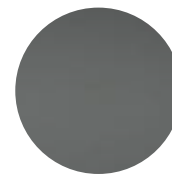

Colour 286
(Trend Fg 57069 Light Grey)

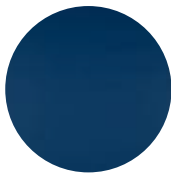

Colour 292
(Fg 68746 Blue)

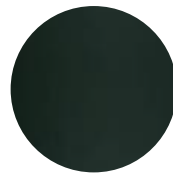

Colour 293
(Trend Fg 77773 Dark Green)

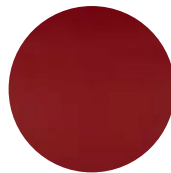

Colour 296
(Trend Fg 23660 Cherry)

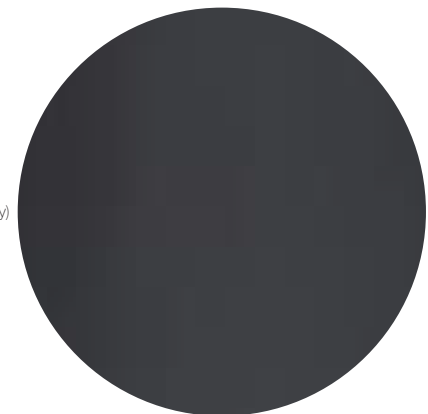

Colour 289
(Fg 58290 Stone)

Several of our products can be used in hospital environments and other similar operations. To ensure that the product meets the hygienic requirements placed on products in these environments, we recommend using the fabrics listed on this page. These textiles can be disinfected with cleaning products and have a moisture barrier that prevents bacteria from penetrating the product.



SANDY SOFA

Constructed of MDF, covered with foam and textile.
Base in oak, ash, walnut, black or white laminate.

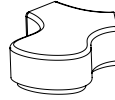

Sandy middle section
W. 1450 H. 460 D. 1260
647600-

Pricer. 4
| 1949,26 |

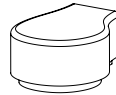

Sandy outer section
W. 990 H. 460 D. 785
647601-

| 1279,04 |



Sandy pouf
W. 945 H. 460 D. 745
647602-

| 1167,34 |



Sandy Sofa with pouf
A complete sofa with 1x middle section, 2x outer sections and 1x pouf.
All sections in the same textile and the same laminate.
W. 1450 H. 460 D. 1260
647603-

| 4350,85 |

Laminate
910 ash
911 oak
912 walnut
913 White
914 Black

How to order Sandy:

- 1: Choose Sandy section. Example: 647600 (middle section).
- 2: Choose textile for Sandy. Example: 647600-338 (Pearl 338 Java).
Colour on textile = color on seam.
- 3: Choose color on laminate. Example: 647600-338-910 (ash laminate).



OFFICE BALLZ

Office Ballz

Delivered with a pump. Max loading 125 kg.

		Pricer. 2	Pricer. 4
640055-	Ø 550	375,21	505,74
640065-	Ø 650	392,77	519,15

Specify the article number as follow:
Office Ballz - textile colour - zip colour.
Choose Care, Creek or Illusion.
Not available with fishbone zip.
Seam will be similar to zipper tape.



OFFICE NAP

Office Nap

Inner bag covered with the textile of your choice.

The bottom is always in grey artificial leather.

W. 600 H. 300 L. 1400	Pricer. 4
640075-	820,64

Specify the article number as follow:
Office Nap - textile colour - zip colour.
Choose Creek or Illusion.
Not available with fishbone zip.
Seam will be similar to zipper tape.



IQSEAT/IQUBE

iQseat

Seam is always like textile. Details/wheels can be chosen in white or black. Two lockable wheels. Max loading: 144 kg.

		Pricer. 2	Pricer. 4
Seat height: 500 mm.			
W. 500 H. 840 D. 690			
647503- white	1205,96	1297,66	
647504- black	1205,96	1297,66	

iQube

Seam always matches the fabric. Wheels in white or black of which two are lockable. Maximum load 144 kg. Seat height 500 mm. The product are delivered as pre-assembled.

W. 500 H. 500 D. 500			
647510- white	802,77	902,55	
647511- black	802,77	902,55	

Specify the article number as follow:
Qseat/iQube - Colour of textile.
Choose Care, Creek or Illusion.
Seam will be similar to textile colour.

SCREENIT A30 DESK SCREEN



Specify the article number as follows:
Screen - Color of textile (seam will be similar to textile).
Choose textile Care, Creek or Illusion.

ScreenIT A30 desk screen 650 mm			Pricer. 2	Pricer. 4
With seam				
642960-	W. 600	H. 650	186,17	265,00
642970-	W. 700	H. 650	195,53	303,62
643080-	W. 800	H. 650	192,77	443,30
643120-	W. 1200	H. 650	276,91	505,74
643140-	W. 1400	H. 650	289,36	512,87
643160-	W. 1600	H. 650	302,02	515,74
643180-	W. 1800	H. 650	347,77	552,98
643200-	W. 2000	H. 650	406,28	633,83
With zip				
642960-	W. 600	H. 650	210,96	289,68
642970-	W. 700	H. 650	222,98	330,21
643080-	W. 800	H. 650	236,81	486,81
643120-	W. 1200	H. 650	320,96	549,15
643140-	W. 1400	H. 650	333,40	556,49
643160-	W. 1600	H. 650	346,06	559,26
643180-	W. 1800	H. 650	391,81	596,60
643200-	W. 2000	H. 650	450,43	677,45

ScreenIT A30 desk screen 800 mm			Pricer. 2	Pricer. 4
With seam				
664060-	W. 600	H. 800	192,87	271,60
664070-	W. 700	H. 800	234,26	409,79
664080-	W. 800	H. 800	267,23	667,02
664120-	W. 1200	H. 800	330,00	702,66
664140-	W. 1400	H. 800	364,15	802,13
664160-	W. 1600	H. 800	397,77	873,30
664180-	W. 1800	H. 800	435,32	944,68
664200-	W. 2000	H. 800	471,38	1072,77
With zip				
664060-	W. 600	H. 800	217,66	296,06
664070-	W. 700	H. 800	288,09	459,68
664080-	W. 800	H. 800	311,06	710,43
664120-	W. 1200	H. 800	373,83	746,28
664140-	W. 1400	H. 800	408,09	845,64
664160-	W. 1600	H. 800	441,60	917,02
664180-	W. 1800	H. 800	479,26	988,19
664200-	W. 2000	H. 800	515,43	1116,28

SCREENIT A30 FLOOR SCREEN

ScreenIT A30 floor screen

ScreenIT A30 floor screen			Pricer. 2	Pricer. 4
With seam				
632120-	W. 800	H. 1200	337,13	702,66
632140-	W. 800	H. 1400	372,13	802,13
632160-	W. 800	H. 1600	406,28	873,30
632180-	W. 800	H. 1800	444,26	944,68
634120-	W. 1000	H. 1200	412,02	775,21
634140-	W. 1000	H. 1400	431,70	818,19
634160-	W. 1000	H. 1600	448,19	903,30
634180-	W. 1000	H. 1800	563,30	946,28
636120-	W. 1200	H. 1200	471,81	782,55
636140-	W. 1200	H. 1400	488,62	839,68
636160-	W. 1200	H. 1600	506,28	946,81
636180-	W. 1200	H. 1800	595,21	988,83
669120-	W. 1400	H. 1200	488,62	839,68
669140-	W. 1400	H. 1400	535,11	1098,19
669160-	W. 1400	H. 1600	570,00	1192,45
669180-	W. 1400	H. 1800	667,23	1286,38
653120-	W. 1600	H. 1200	512,55	946,81
653140-	W. 1600	H. 1400	570,00	1192,45
653160-	W. 1600	H. 1600	627,98	1288,40
With zip				
632120-	W. 800	H. 1200	381,28	746,28
632140-	W. 800	H. 1400	415,96	845,64
632160-	W. 800	H. 1600	450,43	917,02
632180-	W. 800	H. 1800	488,30	988,19
634120-	W. 1000	H. 1200	455,96	818,62
634140-	W. 1000	H. 1400	475,85	861,91
634160-	W. 1000	H. 1600	492,13	946,81
634180-	W. 1000	H. 1800	616,49	988,83
636120-	W. 1200	H. 1200	515,96	826,06
636140-	W. 1200	H. 1400	532,66	882,98
636160-	W. 1200	H. 1600	550,21	990,11
636180-	W. 1200	H. 1800	648,40	1010,11
669120-	W. 1400	H. 1200	532,66	882,98
669140-	W. 1400	H. 1400	579,04	1157,98
669160-	W. 1400	H. 1600	613,83	1251,81
669180-	W. 1400	H. 1800	710,96	1345,11
653120-	W. 1600	H. 1200	556,38	990,11
653140-	W. 1600	H. 1400	613,83	1251,81
653160-	W. 1600	H. 1600	671,70	1352,13

SCREENIT HEALTH & CARE

ScreenIT Health & Care

Built with a wood frame with 30 mm core material and dressed in vinyl that can easily be disinfected and wiped with alcohol based cleaner. Can be connected with press studs.

ScreenIT Health & Care incl. foot set with wheels

Foot set with wheels is always white.

	Pricer. 2	Pricer. 4
810115- W. 1150 H. 1860	876,06	1049,68

ScreenIT Health & Care incl. foot set

Foot set is always white.

811115- W. 1150 H. 1860	766,49	970,96
-------------------------	--------	--------

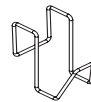

Hook for Health & care

671092-1	white	13.09
----------	-------	-------

Specify the article number as follows:
 Screen - Color of textile (seam will be similar to textile).
 Choose textile Care, Creek or Illusion.



ScreenIT Health & Care is a floor screen that has been designed for the health care sector. It is built with a wood frame, filled with 30 mm soft core material and dressed in vinyl, which is easy to disinfect and wipe clean with alcohol based cleaner. The screen's long sides are both equipped with press studs to enable connecting as many screens as you want. Choose wheels or foot set for the screen for mobility and storage.

Thanks to the air gap between the bottom of the screen and the floor, cleaning under and around the screen is made easier. Usable in spaces such as: waiting rooms, corridors, schools, lunch rooms and the health and care sectors in general.





(A)

Clamp set for desk screen
For up to 42 mm desks. 2 pcs in one pack.
641010-1 White -2 Black -3 Silver 55.21/set

Clamp set for desk screen longer than 1800 mm
For up to 42 mm desks, 3 pcs in one pack.
641056-1 White -2 Black -3 Silver 82.66/set



(B)

Clamp set for desk screen
For up to 72 mm desks, 2 pcs in one pack.
641025-1 White -2 Black -3 Silver 66.17/set

Clamp set for desk screen longer than 1800 mm
For up to 72 mm desks, 3 pcs in one pack.
641035-1 White -2 Black -3 Silver 90.32/set



(C)

Corner clamp set, A30
For clamping side and frontal screens at 90°. For 42 mm desks. 2 pcs in one pack.
641050-1 White -2 Black -3 Silver 60.53/set



(D)

Corner mount set A30
For clamping side and frontal screens at 90°. For 72 mm desks. 2 pcs in one pack.
641045-1 White -2 Black -3 Silver 73.51/set



(E)

Desk mount Light
Mounted with screws under the desk. 2 pcs mounts included. Max load 6 kg.
643047-1 White -2 Black -3 Silver 42.98/set

Desk mount Light for desk screen longer than 1800 mm
Mounted with screws under the desk. 3 pcs mounts included. Max load 6 kg.
643049-1 White -2 Black -3 Silver 75.53/set



(F)

Desk mount corner Light
Used for corner mount. Mounted with screws under the desk. 2 pcs mounts included. Max load 6 kg.
643046-1 White -2 Black -3 Silver 42.98/set

Deskcorner mount Light for desk screen longer than 1800 mm
Used for corner mount. Mounted with screws under the desk. 3 pcs mounts included. Max load 6 kg.
643048-1 White -2 Black -3 Silver 75.53/set

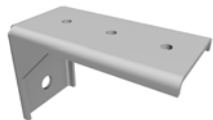

(G)

Desk mount set for desk screen
To be mounted with screws under the desk, 2 pcs in one pack.
641020-1 White -2 Black -3 Silver 55.21/set

Desk mount set for desk screen longer than 1800 mm
To be mounted with screws under the desk, 3 pcs in one pack.
641057-1 White -2 Black -3 Silver 82.66/set



(H)

Corner mount set A30
For mounting side and frontal screens at 90°. To be mounted with screws under the desk. 2 pcs in one pack.
641058-1 White -2 Black -3 Silver 55.21/set



(I)

Desk mount set Slide-in.
To be mounted with screws under the desk, 2 pcs in one pack.
641085-1 White -2 Black -3 Silver 73.51/set



(J)

Desk mount set for Halfpipe with keyhole
To be mounted with screws under the desk, 2 pcs in one pack.
642065-3 Silver 66.81/set



(K)

Desk clamp adjustable for screens without holes
For up to 42 mm desks. 2 pcs in one pack, right/left.
642032-1 White -2 Black -3 Silver 71.38/set



(L)

Desk mount adjustable for screens without holes
To be mounted with screws under the desk. Not possible to use 2 mounts in the same angle. 2 pcs in one pack, right/left.
642033-1 White -2 Black -3 Silver 56.91/set



(M)

Desk mount adjustable extended for screens without holes

To be mounted with screws under the desk, 2 pcs in one pack, right/left.

642043-1 White -2 Black -3 Silver 67.66/set



(N)

Clamp for desk with aluminium rail

2 pcs in one pack.

642062-1 White -2 Black -3 Silver 50.00/set



(O)

OnOff Desk mount

One part is mounted with screw under the desk. One part is mounted on the screen. To hook on and off. 2 pcs in one pack.

642077-1 White -2 Black -3 Silver 67.98/set



(P)

Desk clamp for ScreenIT A30 Sidescreen

For up to 42 mm desks. 1 clamp included.

642068-1 White -2 Black -3 Silver 59.79



(Q)

Desk clamp right for ScreenIT A30 Sidescreen

For up to 42 mm desks. 1 clamp included.

642082-1 White -2 Black -3 Silver 61.38



(R)

Desk clamp left for ScreenIT A30 Sidescreen

For up to 42 mm desks. 1 clamp included.

642083-1 White -2 Black -3 Silver 61.38



(S)

Desk clamp Small for ScreenIT A30 Sidescreen

For up to 27 mm desks. 1 clamp included.

643011-1White -2 Black -3 Silver 59.79



(T)

Desk clamp Small right for ScreenIT A30 Sidescreen

For up to 27 mm desks. 1 clamp included.

643012-1White -2 Black -3 Silver 61.38



(U)

Desk clamp Small left for ScreenIT A30 Sidescreen

For up to 27 mm desks. 1 clamp included.

643013-1White -2 Black -3 Silver 61.38

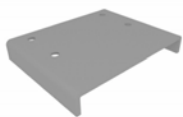

(V)

Metal plate for angled edge desks

When the clamps need stable grip with angled edge. 1 clamp included.

66500 Silver 24.47



(X)

Angle bracket for desk screen

Used for corner mounting to hold the screens together. 1pc mount incl.

Angle bracket for ScreenIT Standard

642034-1 White -2 Black -3 Silver 14.15

Angle bracket for ScreenIT AT40

642036-1 White -2 Black -3 Silver 14.15

Angle bracket for ScreenIT A30/A40

642046-1 White -2 Black -3 Silver 14.15



(Y)

Clamp set for booth, package

For up to 42 mm desks. 6 clamps includes. 2 clamps and 4 corner clamps.

641068-1White -2 Black -3 Silver 167.98/set

Z



Clamp set for booth, package
For up to 72 mm desks. 6 clamps includes.
2 clamps and 4 corner clamps.
641071-1White -2 Black -3 Silver 201.17/set

Å

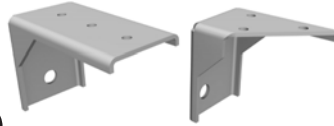

Desk mount for desk booth, package
To be mounted with screws under the desk.
2 desk mount and 4 corner desk mount.
641069-1 White -2 Black -3 Silver 143.30/set

Ä



Desk mount Mini to the desk booth, package
Assembled with screws under the desk.
4 brackets are included. 2 Mini desk mounts
and 2 Slim corner mounts.
642027-1White -2 Black -3 Silver 104.57/set

Ö

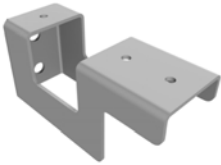

Desk mount with recess for a beam
To be mounted with screws under the desk.
2 pcs in one pack.
642042-1White -2 Black -3 Silver 58.83/set

AA



Desk mount Slim
To be mounted with screws under the desk.
2 pcs in one pack. Right and left.
642010-1White -2 Black -3 Silver 55.21/set

BB



Desk mount Slim, two screens
Mounted with screws under the desk.
3 mounts included: 1 pc right, 1 pc left,
1 pc Slim corner mount.
642020-1White 79.89/set

CC



Desk mount Slim, three screens
Mounted with screws under the desk. 4 pcs
mounts included: 1 pc right, 1 pc left,
2 pc Slim corner mounts.
642030-1 White 108.94/set

DD

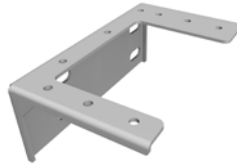

Desk mount Slim reinforced
To be mounted with screws under the desk.
2 pcs in one pack. Right and left.
643010-1 White -2 Black -3 Silver 64.36/set

EE



Desk mount for ScreenIT for angled desk sides
To be mounted with screws under the desk,
2 pcs in one pack.
642075-1 White -2 Black -3 Silver 57.34/set

Desk mount for ScreenIT for angled desk sides, 3 pack
To be mounted with screws under the desk,
3 pcs in one pack.
642085-1 White -2 Black -3 Silver 88.40/set

GG



Desk clamp for A30 above desk
For up to 42 mm desks.
Content: 2 desk clamp and 2 pins.
642090-1 White -2 Black -3 Silver 78.72/set

HH



Desk clamp Small for A30 above desk
For up to 42 mm desks.
Content: 2 desk clamp and 2 pins.
642088-1 White -2 Black -3 Silver 63.30/set

II



Pin for A30 above desk
Content 2 pins. Can be screwed above
and below desks. When mounted under a
desk, two 10 mm holes are drilled through
the desk top.
642095-1 White -2 Black -3 Silver 28.19/set

JJ



Pins for A30 above desk, completion
Content 2 pins. Can be screwed above
and below desks. When mounted under a
desk, two 10 mm holes are drilled
through the desk top.
642089-1 White -2 Black -3 Silver 28.19/set

KK



Foot for A30 above desk

Content 2 pins with circular foot, Ø105 mm. Standing on the desk. Felt pads included.

642093-1 White -2 Black -3 Silver 49.79/set

LL



Foot set for A30 Floor screen

4 in one pack. Approx. 25 mm between floor and bottom of the floor screen.

641040-1 White -2 Black -3 Silver 76.81

MM



Corner foot set support for angled screens, A30

4 in one pack. 3 standard and 1 angle.

641055-1 White -2 Black -3 Silver 76.81

NN



Foot Set with wheels for A30 Floor screen

Lockable wheels. 4 in one pack. Approx. 45 mm between floor and bottom of screen.

641066-1 White -2 Black -3 Silver 136.06

OO

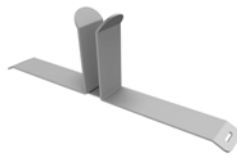

Foot set Slide-in for A30 Floor screen without hole

2 pcs in one pack.

641075-1 White -2 Black -3 Silver 120.85/set

PP



Desk clamp/corner mount for two screens

For up to 42 mm desks. 4 clamps includes. 2 clamps and 2 corner clamps.

641076-1 White -2 Black -3 Silver 110.32/set



QQ

Foot set Woodland for Floorscreen A30

Foot in molded wood with ash veneer and metal fittings that fit A30 floor screen. 4 feet included.

643068-1	White*/ash	257.98
643068-2	Black*/ash	257.98
643068-3	Silver*/ash	257.98

* Color indicates fittings.



SS

Foot set Woodland with wheels for Floorscreen A30

Foot set in molded wood with ash veneer and metal fittings that fits A30 floor screen.

4 feet with wheels included. The wheels are lockable.

643067-1	White*/ash	335.43
643067-2	Black*/ash	335.43
643067-3	Silver*/ash	335.43

* Color indicates wheels and fittings.



RR

Foot set Woodland for A40/Sketch Floorscreen

Foot in molded wood with ash veneer and metal fittings that fit Sketch / A40 floor screen.

4 feet included.

643066-1	White*/ash	257.98
643066-2	Black*/ash	257.98
643066-3	Silver*/ash	257.98

* Color indicates fittings.



TT

Foot Set Slide-in Woodland with wheels for A40/Sketch Floor screen

Foot set in molded wood with ash veneer and metal fittings that fits Sketch/A40 floor screen. 4 feet with wheels included. The wheels are lockable.

643065-1	White*/ash	335.43
643065-2	Black*/ash	335.43
643065-3	Silver*/ash	335.43

* Color indicates wheels and fittings.

UU



Clamp set for desk screen for angled edge desks

For up to 42 mm desks. 2 pcs in one pack. Not suitable for reinforced screens.

643015-1 White -2 Black -3 Silver 55.21/set

Clamp set for desk screen for angled edge desks longer than 1800 mm

For up to 42 mm desks. 3 pcs in one pack. Not suitable for reinforced screens.

643016-1 White -2 Black -3 Silver 82.66/set



Adjustable height screen mount set

Height adjustable 280 mm. To be ordered with mount or clamp. 2 pcs in one pack.













641059-3 Silver 45.21/set

Adjustable height screen mount set longer than 1800 mm

Height adjustable 280 mm. To be ordered with mount or clamp. 3 pcs in one pack.

641060-3 Silver 67.66/set

COMPARE SCREENS

PAGE	SCREEN	PAGE	SCREEN
28	 <p>ScreenIT Standard The most competitive priced screen with a solid core and foam laminated textile. Transmission effectiveness, meaning no noise penetration. Total thickness 20 mm. Max load 6 kg.</p>	33	 <p>ScreenIT A30 with built in rail Reinforced A30 with a built in toolbar. Takes up to 25 kg in accessories, monitors etc.</p>
29	 <p>ScreenIT A30 Wooden frame filled with sound absorbing anti-allergy foam and lined with foam laminated textile. Total thickness 40 mm. Max load 6 kg.</p>	34	 <p>ScreenIT AT40 AT40 is made of a solid wood core with A-classed sound absorbing material on both sides. Total thickness 40 mm.</p>
30	 <p>ScreenIT A30 Flexible/Wall As ScreenIT A30 without holes. Can be used as a desk or floor screen or wall mounted.</p>	35	 <p>ScreenIT Plexi Desk screen made of acrylic plastic (plexi). Available in frosted, smoked, transparent.</p>
31	 <p>ScreenIT A30 Slide Slidable A30 screen mounted on a rail for horizontal movement. Ideal for workstations placed opposite each other.</p>	36	 <p>Peak Desk screen booth Desk screen solution with a slight tilted side screen. Material like ScreenIT A30.</p>
32	 <p>ScreenIT A30 Reinforced A wooden reinforced screen filled with sound absorbing material, pin able and with foam laminated textile. 40 mm thick. Takes up to 25 kg in accessories, monitors etc.</p>	36-37	 <p>ScreenIT A30 Desk booth / ScreenIT A30 Above desk Screen and side screens zipped together in the corners. Material like ScreenIT A30.</p>
32	 <p>ScreenIT A40 Material as A30 but with a thicker absorber. Total thickness 50 mm.</p>	38	 <p>Silent Express Silent Express is a stocked screen. Total thickness: 32 mm. Max load: 0 kg.</p>

Read more and compare our Floor screens och Floor Screen Booths in the Floor Screen Chapter.

DESK SCREENS AND BOOTHS

An easy way to create a personal space and privacy, even in the most open office landscape. Our desk screens and booths protect you from both sound and visual distractions while their colour and shape contribute to a creative and productive environment. Several screens and textiles are Swan labeled in combination with each other. See the specification below. For more information regarding textiles, see page 6-16.

ORDER PROCEDURE

DESK SCREENS

1. SELECT SCREEN AND SCREEN SIZE
2. SELECT TEXTILE COLOUR
See colour map at page 6-16.
3. SELECT ZIP OR SEAM COLOUR
See colours on page 17.
4. SELECT CLAMPS OR MOUNTS
See page 22-25.

Specify the article number as follows:
Desk screen size - textile colour - zip/seam colour.
Example: 644140 - 01 - 101.

Below screens and textiles are Nordic Eco labeled in combination with each other.

SCREENS

ScreenIT Standard
ScreenIT A30
ScreenIT A30 Reinforced
ScreenIT A30 Desk screen booth
ScreenIT A30 Flexible
ScreenIT Slide
ScreenIT AT40

TEXTILES

Event Screen +
Mica
Xpress
Cara
Rivet
Twist
Bond
Synergy
Remix 3



DESK SCREEN BOOTH

1. SELECT SCREEN AND SCREEN SIZE
2. SELECT TEXTILE COLOUR
See colour map at page 6-16.
3. SELECT SEAM COLOUR ON SCREEN
See colours on page 17.
4. SELECT ZIP TO CONNECT SCREENS
See colours on page 17.
5. SELECT CLAMPS OR MOUNTS
See page 22-25.

Specify the article number as follows:
Screen booth - textile colour - seam colour - zip colour.
Example: 1178160 - 14 - 206 - 101.



ScreenIT Standard comes at a very affordable price. Combine textile, zip or seam as desired. The screen has a solid core covered by a foam laminated textile for sound absorption. Hole pattern from outer edge: 150 mm. It is also possible to use as pinboard or mount a toolbar for accessories. Maximum load 6 kg.



A thicker alternative to ScreenIT Standard that can take a load up to 25 kg. Built with a 16 mm thick MDF-board, dressed in laminated textile with a total thickness of 26 mm. Hole pattern from outer edge: 250 mm.

SCREENIT STANDARD

ScreenIT Standard 650 mm

See price ranges in textile chapter.

			Pricer. 1	Pricer. 2	Pricer. 3	Pricer. 4
With seam						
640080-	W. 800	H. 650	164,89	178,09	333,62	426,81
640120-	W. 1200	H. 650	212,45	242,98	379,79	473,19
640140-	W. 1400	H. 650	228,19	263,09	395,11	488,51
640160-	W. 1600	H. 650	243,94	290,96	410,43	503,94
640180-	W. 1800	H. 650	259,79	320,43	425,85	519,15
640200-	W. 2000	H. 650	275,85	354,79	441,06	534,47
With zip						
640080-	W. 800	H. 650	212,45	225,43	379,79	473,19
640120-	W. 1200	H. 650	259,89	290,11	425,96	519,26
640140-	W. 1400	H. 650	275,96	310,43	441,28	534,57
640160-	W. 1600	H. 650	291,49	338,19	456,60	549,89
640180-	W. 1800	H. 650	307,55	367,77	471,81	565,21
640200-	W. 2000	H. 650	322,98	402,13	487,23	580,43

ScreenIT Standard 800 mm

			Pricer. 1	Pricer. 2	Pricer. 3	Pricer. 4
With seam						
663080-	W. 800	H. 800	209,47	212,02	437,34	616,49
663120-	W. 1200	H. 800	257,02	273,40	499,04	678,51
663140-	W. 1400	H. 800	273,09	296,17	601,17	780,21
663160-	W. 1600	H. 800	288,62	347,02	674,26	853,51
663180-	W. 1800	H. 800	304,47	370,00	747,45	926,70
663200-	W. 2000	H. 800	320,43	392,55	777,98	1003,51
With zip						
663080-	W. 800	H. 800	257,02	259,36	483,19	662,66
663120-	W. 1200	H. 800	304,57	320,53	545,21	724,36
663140-	W. 1400	H. 800	320,53	343,30	647,23	826,60
663160-	W. 1600	H. 800	336,28	394,26	720,21	899,68
663180-	W. 1800	H. 800	351,91	417,23	793,51	972,98
663200-	W. 2000	H. 800	367,87	440,21	824,15	11049,68

Facts: Desk thickness 20 mm applies to following measures.

Screens H:650 mm: Clamp = H:450 mm above desk. Deskmount

= H:430 mm above desk. Screens H:800 mm: Clamp = H:600

mm above desk. Deskmount = H:580 mm above desk.

Max load 6 kg.

The brackets below fit the above items.

See all mounts on pages 22-25.



641010 641025 643047 643046 641020 642034 642075 643015
641056 641035 641057 642085 643016

SCREENIT STANDARD REINFORCED

ScreenIT Standard Reinforced 650 mm

See price ranges in textile chapter.

			Pricer. 1	Pricer. 2	Pricer. 3	Pricer. 4
With seam						
500080-	W. 800	H. 650	193,94	202,02	361,91	455,32
500120-	W. 1200	H. 650	259,89	290,00	425,96	519,26
500140-	W. 1400	H. 650	267,66	303,19	433,30	526,70
500160-	W. 1600	H. 650	270,74	316,49	436,28	529,68
500180-	W. 1800	H. 650	309,79	364,36	474,15	567,77
500200-	W. 2000	H. 650	395,85	425,64	557,55	650,85
With zip						
500080-	W. 800	H. 650	240,11	248,09	406,49	499,89
500120-	W. 1200	H. 650	305,96	336,17	470,64	563,83
500140-	W. 1400	H. 650	313,72	349,36	477,87	571,38
500160-	W. 1600	H. 650	316,81	362,45	480,85	574,26
500180-	W. 1800	H. 650	355,96	410,43	518,94	612,55
500200-	W. 2000	H. 650	441,60	471,81	587,77	695,53

ScreenIT Standard Reinforced 800 mm

			Pricer. 1	Pricer. 2	Pricer. 3	Pricer. 4
With seam						
558080-	W. 800	H. 800	268,51	280,00	478,94	685,11
558120-	W. 1200	H. 800	334,47	345,64	572,02	721,60
558140-	W. 1400	H. 800	342,13	381,60	675,43	823,72
558160-	W. 1600	H. 800	345,21	416,60	739,89	896,70
558180-	W. 1800	H. 800	384,36	455,96	823,09	969,89
558200-	W. 2000	H. 800	470,21	493,83	881,70	1101,60
With zip						
558080-	W. 800	H. 800	314,57	325,96	523,62	729,57
558120-	W. 1200	H. 800	380,32	391,70	616,60	766,38
558140-	W. 1400	H. 800	388,09	427,55	720,00	868,40
558160-	W. 1600	H. 800	391,17	462,66	784,57	941,49
558180-	W. 1800	H. 800	430,43	502,02	867,77	1014,79
558200-	W. 2000	H. 800	516,17	540,00	926,28	1146,28

Facts: Max load 25 kg. Total screen thickness 26 mm. Desk thickness

20 mm applies to following measures. Screens H:650 mm: Deskmount

= H:430 mm above desk. Screens H:800 mm: Deskmount = H:580

mm above desk. Freewall not included, see Toolbar chapter.

The brackets below fit the above items.

See all mounts on pages 22-25.

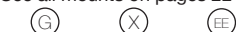

641020 642034 642075
641057 642085

Order procedure desk screen, see page 27.



The screen is developed to maximize sound absorption. It has a wooden frame filled with 30 mm sound absorbing material and is coated with a foam laminated textile. It is also possible to use as pinboard. Max load 6 kg. Total thickness 40 mm. For A30 Reinforced or A30 with built in rail.



SCREENIT A30 P1 AND A30 K DESK SCREEN

A30 P1 and A30 K have the same features as the A30, for details see above. The difference is the measurement from the outer edge to the bolt hole. A30 = 45 mm, A30 P1 = 150 mm and A30 K = 250 mm from the outer edge. Article numbers in column beside is for ScreenIT A30, if you want to order A30 P1 or A30 K, please contact Götessons.

SCREENIT A30

ScreenIT A30 Desk Screen 650 mm *See price ranges in textile chapter.*

With seam	Pricer. 1	Pricer. 2	Pricer. 3	Pricer. 4
642960- W. 600 H. 650	170,53	186,17	212,02	265,00
642970- W. 700 H. 650	175,54	189,79	252,98	303,62
643080- W. 800 H. 650	183,40	192,77	338,83	443,30
643120- W. 1200 H. 650	245,85	276,91	398,83	505,74
643140- W. 1400 H. 650	252,98	289,36	405,74	512,87
643160- W. 1600 H. 650	255,96	302,02	408,62	515,74
643180- W. 1800 H. 650	292,77	347,77	444,04	552,98
643200- W. 2000 H. 650	374,26	406,28	522,02	633,83

With zip	Pricer. 1	Pricer. 2	Pricer. 3	Pricer. 4
642960- W. 600 H. 650	195,53	210,96	236,17	289,68
642970- W. 700 H. 650	204,79	216,49	274,36	330,21
643080- W. 800 H. 650	227,02	236,81	380,53	486,81
643120- W. 1200 H. 650	289,36	320,96	440,64	549,15
643140- W. 1400 H. 650	296,60	333,40	447,45	556,49
643160- W. 1600 H. 650	299,47	346,06	450,32	559,26
643180- W. 1800 H. 650	336,60	391,81	486,06	596,60
643200- W. 2000 H. 650	417,55	450,43	550,43	677,45

ScreenIT A30 Desk Screen 800 mm

With seam	Pricer. 1	Pricer. 2	Pricer. 3	Pricer. 4
664060- W. 600 H. 800	177,55	192,87	218,83	271,60
664070- W. 700 H. 800	224,04	234,26	346,17	409,79
664080- W. 800 H. 800	253,83	267,23	448,51	667,02
664120- W. 1200 H. 800	316,17	330,00	535,64	702,66
664140- W. 1400 H. 800	323,40	364,15	632,45	802,13
664160- W. 1600 H. 800	326,28	397,77	692,87	873,30
664180- W. 1800 H. 800	363,30	435,32	770,74	944,68
664200- W. 2000 H. 800	444,47	471,38	825,53	1072,77

With zip	Pricer. 1	Pricer. 2	Pricer. 3	Pricer. 4
664060- W. 600 H. 800	202,13	217,66	242,45	296,06
664070- W. 700 H. 800	266,38	288,09	385,96	459,68
664080- W. 800 H. 800	297,45	311,06	490,43	710,43
664120- W. 1200 H. 800	359,57	373,83	577,34	746,28
664140- W. 1400 H. 800	366,91	408,09	674,26	845,64
664160- W. 1600 H. 800	369,89	441,60	734,68	917,02
664180- W. 1800 H. 800	406,91	479,26	812,66	988,19
664200- W. 2000 H. 800	487,98	515,43	867,23	1116,28

Facts: Desk thickness 20 mm applies to following measures. Screens H:650 mm: Clamp = H:450 mm above desk. Deskmount = H:430 mm above desk. Screens H:800 mm: Clamp = H:600 mm above desk. Deskmount = H:580 mm above desk. Max load 6 kg.

SCREENIT A30 STRAIGHT CORNERS

ScreenIT A30 650 mm *See price ranges in textile chapter.*

With seam	Pricer. 1	Pricer. 2	Pricer. 3	Pricer. 4
543080- W. 800 H. 650	183,40	192,77	338,83	443,30
543120- W. 1200 H. 650	245,85	276,91	398,83	505,74
543140- W. 1400 H. 650	252,98	289,36	405,74	512,87
543160- W. 1600 H. 650	255,96	302,02	408,62	515,74
543180- W. 1800 H. 650	292,77	347,77	444,04	552,98
543200- W. 2000 H. 650	374,26	406,28	522,02	633,83

With seam	Pricer. 1	Pricer. 2	Pricer. 3	Pricer. 4
564080- W. 800 H. 800	253,83	267,23	448,51	667,02
564120- W. 1200 H. 800	316,17	330,00	535,64	702,66
564140- W. 1400 H. 800	323,40	364,15	632,45	802,13
564160- W. 1600 H. 800	326,28	397,77	692,87	873,30
564180- W. 1800 H. 800	363,30	435,32	770,74	944,68
564200- W. 2000 H. 800	444,47	471,38	825,53	1072,77

Facts: Desk thickness 20 mm applies to following measures. Screens H:650 mm: Clamp = H:450 mm above desk. Deskmount = H:430 mm above desk. Screens H:800 mm: Clamp = H:600 mm above desk. Deskmount = H:580 mm above desk. Max load 6 kg.

The brackets below fit the above items.

See all mounts on pages 22-25.

(A)	(B)	(C)	(D)	(E)	(F)
641010	641025	641050	641045	643047	643046
641056	641035				
(G)	(H)	(EE)	(UU)		
641020	641058	642075	643015		
641057		642085	643016		

Order procedure desk screen, see page 27.



The screen can be used as a desk, floor and wall screen. This screen is without holes and can be ordered with height adjustable mounting brackets. The screen can then easily be moved up and down with an Allen key. See video on www.gotessons.com.



SCREENIT A30 FLEXIBLE

ScreenIT A30 Flexible 650 mm, zipper on long side

See price ranges in textile chapter.

With seam	Pricer. 1	Pricer. 2	Pricer. 3	Pricer. 4
627080- W. 800 H. 650	183,40	192,77	338,83	443,30
627120- W. 1200H. 650	245,85	276,91	398,83	505,74
627140- W. 1400H. 650	252,98	289,36	405,74	512,87
627160- W. 1600H. 650	255,96	302,02	408,62	515,74
627180- W. 1800H. 650	292,77	347,77	444,04	552,98
627200- W. 2000H. 650	374,26	406,28	522,02	633,83
With zip				
627080- W. 800 H. 650	227,02	236,81	380,53	486,81
627120- W. 1200H. 650	289,36	320,96	440,64	549,15
627140- W. 1400H. 650	296,60	333,40	447,45	556,49
627160- W. 1600H. 650	299,47	346,06	450,32	559,26
627180- W. 1800H. 650	336,60	391,81	486,06	596,60
627200- W. 2000H. 650	417,55	450,43	550,43	677,45

ScreenIT A30 Flexible 800 mm, zipper on long side

With seam				
625080- W. 800 H. 800	253,83	267,23	448,51	667,02
625120- W. 1200H. 800	316,17	330,00	535,64	702,66
625140- W. 1400H. 800	323,40	364,15	632,45	802,13
625160- W. 1600H. 800	326,28	397,77	692,87	873,30
625180- W. 1800H. 800	363,30	435,32	770,74	944,68
625200- W. 2000H. 800	444,47	471,38	825,53	1072,77
With zip				
625080- W. 800 H. 800	297,45	311,06	490,43	710,43
625120- W. 1200H. 800	359,57	373,83	577,34	746,28
625140- W. 1400H. 800	366,91	408,09	674,26	845,64
625160- W. 1600H. 800	369,89	441,60	734,68	917,02
625180- W. 1800H. 800	406,91	479,26	812,66	988,19
625200- W. 2000H. 800	487,98	515,43	867,23	1116,28

ScreenIT A30 Flexible 650 mm, zipper on short side

With seam				
623080- W. 650 H. 800	183,40	192,77	338,83	443,30
623120- W. 650 H. 1200	245,85	276,91	398,83	505,74
623140- W. 650 H. 1400	252,98	289,36	405,74	512,87
623160- W. 650 H. 1600	255,96	302,02	408,62	515,74
623180- W. 650 H. 1800	292,77	347,77	444,04	552,98
623200- W. 650 H. 2000	374,26	406,28	522,02	633,83
With zip				
623080- W. 650 H. 800	227,02	236,81	380,53	486,81
623120- W. 650 H. 1200	289,36	320,96	440,64	549,15
623140- W. 650 H. 1400	296,60	333,40	447,45	556,49
623160- W. 650 H. 1600	299,47	346,06	450,32	559,26
623180- W. 650 H. 1800	336,60	391,81	486,06	596,60
623200- W. 650 H. 2000	417,55	450,43	550,43	677,45

ScreenIT A30 Flexible 800 mm, zipper on short side

With seam				
624080- W. 800 H. 800	253,83	267,23	448,51	667,02
624120- W. 800 H. 1200	316,17	330,00	535,64	702,66
624140- W. 800 H. 1400	323,40	364,15	632,45	802,13
624160- W. 800 H. 1600	326,28	397,77	692,87	873,30
624180- W. 800 H. 1800	363,30	435,32	770,74	944,68
624200- W. 800 H. 2000	444,36	471,38	825,53	1072,77
With zip				
624080- W. 800 H. 800	297,45	311,06	490,43	710,43
624120- W. 800 H. 1200	359,57	373,83	577,34	746,28
624140- W. 800 H. 1400	366,91	408,09	674,26	845,64
624160- W. 800 H. 1600	369,89	441,60	734,68	917,02
624180- W. 800 H. 1800	406,91	479,26	812,66	988,19
624200- W. 800 H. 2000	487,87	515,43	867,23	1116,28

Order procedure desk screen, see page 27.

The brackets below fit the above items.

See all mounts on pages 22-25.



641085 642032 642033 642043 641075

Wall package

List for wall mount.

641063	500 mm	22.66
641064	1000 mm (for screens longer than 1800 mm)	42.77



Horizontal slidable screen mounted on a rail under the desk. Ideal for workstations placed opposite each other.

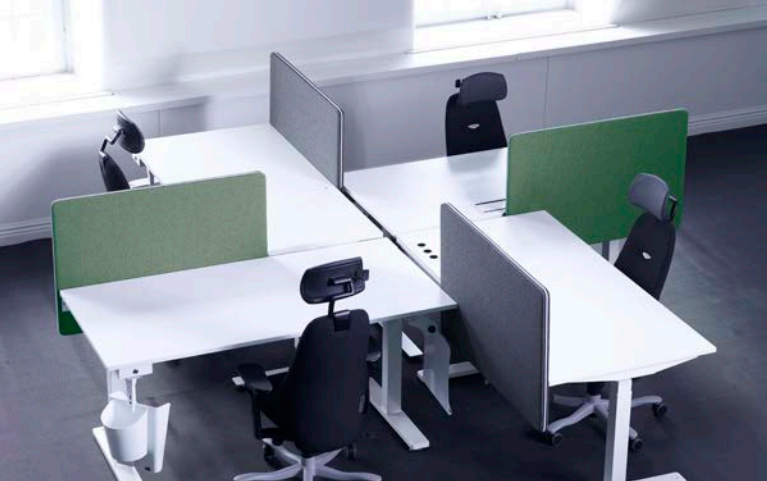
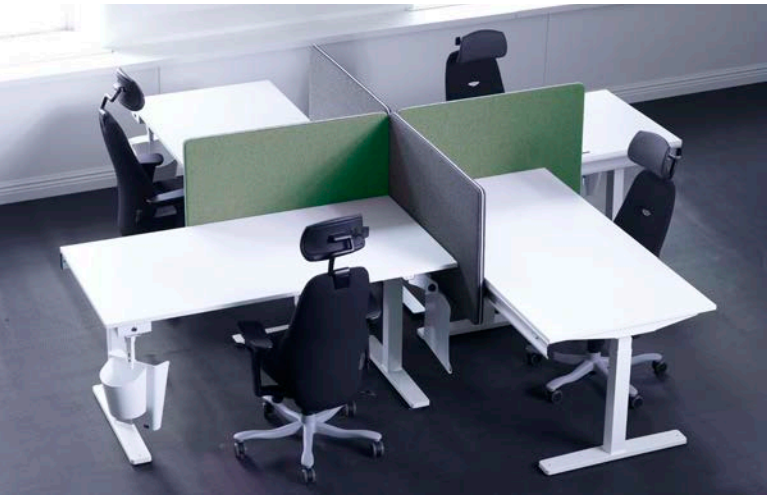

SCREENIT A30 SLIDE

ScreenIT A30 Slide 650 mm

See price ranges in textile chapter.



With seam	Pricer. 1	Pricer. 2	Pricer. 3	Pricer. 4
667080- W. 800 H. 650	188,94	198,51	338,83	443,30
667100- W. 1000 H. 650	221,28	232,34	368,83	474,57
667120- W. 1200 H. 650	253,19	285,21	398,83	505,74
667140- W. 1400 H. 650	260,53	298,09	405,74	512,87
With zip				
667080- W. 800 H. 650	233,83	243,94	380,53	486,81
667100- W. 1000 H. 650	266,06	277,77	410,74	517,98
667120- W. 1200 H. 650	298,09	330,64	440,64	549,15
667140- W. 1400 H. 650	305,53	343,40	447,45	556,49

ScreenIT A30 Slide 800 mm

With seam				
1067080- W. 800 H. 800	261,49	275,21	448,40	667,02
1067100- W. 1000 H. 800	313,30	328,94	504,15	684,79
1067120- W. 1200 H. 800	325,64	339,89	535,64	702,87
1067140- W. 1400 H. 800	333,09	375,11	632,34	802,13
With zip				
1067080- W. 800 H. 800	306,38	320,43	490,43	710,43
1067100- W. 1000 H. 800	358,09	373,94	545,85	728,19
1067120- W. 1200 H. 800	370,32	385,00	577,34	746,28
1067140- W. 1400 H. 800	377,87	420,32	674,15	845,74

Order procedure desk screen, see page 27.

Facts: Screen's height from desk top with clamp if desk is 20 mm thick. 650 mm screen = 420 mm above desk. 800 mm screen = 570 mm above desk. Total thickness 40 mm.

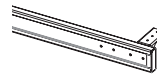

Slide rail for A30 Slide

Extruded aluminium slide rail pack. 1 rail/screen.

668140-1 W. 1400	white	114.57
668140-3 W. 1400	silver	103.19
668160-1 W. 1600	white	128.94
668160-3 W. 1600	silver	117.98
668180-1 W. 1800	white	143.30
668180-3 W. 1800	silver	132.87
668200-1 W. 2000	white	157.77
668200-3 W. 2000	silver	147.77

Slide rail for A30 Slide for Halfpipe with keyhole

Extruded aluminium slide rail pack. 1 rail/screen.

858140-1 W. 1400	white	121.81
858140-3 W. 1400	silver	107.55
858160-1 W. 1600	white	136.17
858160-3 W. 1600	silver	121.81
858180-1 W. 1800	white	150.53
858180-3 W. 1800	silver	136.17
858200-1 W. 2000	white	165.11
858200-3 W. 2000	silver	150.53



The tremendously popular sound absorbing screen A30 is also available as a reinforced model that allows for weights of up to 25 kg. Ideal for hanging up tool arms and other accessories. Max load with desk mount 25 kg.



A40 is constructed with a wooden frame filled with 40 mm sound absorbing materials and foam laminated textile for a good sound absorption. Choose from a variety of textiles and combine with seam or zipper. Total thickness 50 mm. Max load 6 kg.

SCREENIT A30 REINFORCED

ScreenIT A30 Reinforced 650 mm *See price ranges in textile chapter.*

With seam				Pricer. 1	Pricer. 2	Pricer. 3	Pricer. 4
648080-	W. 800	H. 650		270,32	278,30	414,89	522,34
648120-	W. 1200	H. 650		332,87	363,19	473,09	583,30
648140-	W. 1400	H. 650		340,00	376,06	479,89	590,11
648160-	W. 1600	H. 650		342,77	388,72	482,66	592,77
648180-	W. 1800	H. 650		380,11	434,79	517,23	628,83
648200-	W. 2000	H. 650		450,21	482,23	582,66	697,02

With zip				Pricer. 1	Pricer. 2	Pricer. 3	Pricer. 4
648080-	W. 800	H. 650		315,21	323,83	456,60	566,17
648120-	W. 1200	H. 650		377,55	408,30	514,79	626,38
648140-	W. 1400	H. 650		384,79	421,28	521,70	633,51
648160-	W. 1600	H. 650		387,55	434,15	524,47	636,49
648180-	W. 1800	H. 650		424,57	480,11	558,83	672,13
648200-	W. 2000	H. 650		495,00	527,45	624,68	740,53

ScreenIT A30 Reinforced 800 mm

With seam				Pricer. 1	Pricer. 2	Pricer. 3	Pricer. 4
1049080-	W. 800	H. 800		340,53	355,00	522,23	743,94
1049120-	W. 1200	H. 800		402,77	417,98	607,66	777,87
1049140-	W. 1400	H. 800		410,11	452,87	704,47	877,23
1049160-	W. 1600	H. 800		413,30	487,23	764,68	948,19
1049180-	W. 1800	H. 800		450,11	525,00	841,60	1018,19
1049200-	W. 2000	H. 800		520,96	549,15	884,36	1133,94

With zip				Pricer. 1	Pricer. 2	Pricer. 3	Pricer. 4
1049080-	W. 800	H. 800		385,53	400,43	564,15	787,23
1049120-	W. 1200	H. 800		447,77	463,09	649,57	821,38
1049140-	W. 1400	H. 800		455,11	497,98	746,17	920,53
1049160-	W. 1600	H. 800		457,87	532,34	806,60	991,49
1049180-	W. 1800	H. 800		495,00	570,00	883,30	1061,81
1049200-	W. 2000	H. 800		565,64	594,47	926,28	1177,55

Order procedure desk screen, see page 27.

Facts: Max load 25 kg. Total screen thickness 40 mm.

Desk thickness 20 mm applies to following measures.

Screens H:650 mm: Deskmount = H:430 mm above desk.

Screens H:800 mm: Deskmount = H:580 mm above desk.

Freewall not included. See page 42.

The brackets below fit the above items.

See all mounts on pages 22-25.

(G)	(X)	(EE)
641020	642034	642075
641057		642085

SCREENIT A40

ScreenIT A40 Desk Screen 650 mm

With seam				Pricer. 1	Pricer. 2	Pricer. 3	Pricer. 4
1043080-	W. 800	H. 650		194,47	198,51	348,94	456,60
1043120-	W. 1200	H. 650		260,74	285,21	410,74	520,85
1043140-	W. 1400	H. 650		268,19	298,09	417,87	528,19
1043160-	W. 1600	H. 650		271,60	311,06	420,85	531,28
1043180-	W. 1800	H. 650		310,85	358,19	457,45	569,47
1043200-	W. 2000	H. 650		396,91	418,51	537,77	652,87

With zip				Pricer. 1	Pricer. 2	Pricer. 3	Pricer. 4
1043080-	W. 800	H. 650		240,96	245,11	392,13	501,49
1043120-	W. 1200	H. 650		306,91	331,70	453,83	565,96
1043140-	W. 1400	H. 650		314,47	344,68	460,96	573,09
1043160-	W. 1600	H. 650		317,55	357,55	464,04	575,96
1043180-	W. 1800	H. 650		356,91	404,89	500,64	614,15
1043200-	W. 2000	H. 650		442,87	465,11	566,91	697,55

ScreenIT A40 Desk Screen 800 mm

With seam				Pricer. 1	Pricer. 2	Pricer. 3	Pricer. 4
1064080-	W. 800	H. 800		269,47	285,74	461,91	687,02
1064120-	W. 1200	H. 800		335,53	352,23	551,81	724,04
1064140-	W. 1400	H. 800		342,87	388,72	651,49	826,28
1064160-	W. 1600	H. 800		346,28	424,15	713,51	899,57
1064180-	W. 1800	H. 800		385,64	464,15	793,83	973,09
1064200-	W. 2000	H. 800		471,60	502,02	850,21	1104,89

With zip				Pricer. 1	Pricer. 2	Pricer. 3	Pricer. 4
1064080-	W. 800	H. 800		330,21	359,36	505,11	731,81
1064120-	W. 1200	H. 800		381,49	398,83	594,79	768,83
1064140-	W. 1400	H. 800		389,36	435,21	694,47	871,17
1064160-	W. 1600	H. 800		392,45	470,74	756,60	944,47
1064180-	W. 1800	H. 800		431,49	510,53	837,02	1017,66
1064200-	W. 2000	H. 800		517,66	548,40	893,30	1149,79

Facts: Standard height from desk top 450 mm with clamp.

With desk mount 430 mm if desk is 20 mm. Max load 6 kg.

The brackets below fit the above items.

See all mounts on pages 22-25.

(A)	(B)	(C)	(D)	(E)	(F)
641010	641025	641050	641045	643047	643046
641056	641035				
(G)	(H)	(EE)	(UU)		
641020	641058	642075	643015		
641057		642085	643016		



As ScreenIT A30/A40 but with a built in toolbar rail as opposed to screwed on.
Thickness: A30=40 mm. A40=50 mm. Can also be ordered with silver rail to the same price, to order start the article number with 10 instead of 11. Ex.1040080 instead of 1140080.

Can be ordered with other measurement from outer edge to bolt hole: e.g. A30 P1=150mm or A30 K=250mm. Contact Gotessons for article number and price.



SCREENIT A30/A40 WITH BUILT IN RAIL

ScreenIT A30 with built in rail 650 mm, white

See price ranges in textile chapter.



A30 with seam	Pricer. 1	Pricer. 2	Pricer. 3	Pricer. 4
1140080- W. 800 H. 650	347,77	368,62	417,77	508,40
1140120- W. 1200H. 650	447,55	468,51	517,23	684,89
1140140- W. 1400H. 650	481,06	508,19	592,55	749,89
1140160- W. 1600H. 650	521,06	547,13	640,11	860,96
1140180- W. 1800H. 650	586,38	620,32	697,66	944,79
1140200- W. 2000H. 650	634,15	678,94	765,96	1039,15
With zip				
1140080- W. 800 H. 650	391,38	412,55	458,62	550,74
1140120- W. 1200H. 650	491,17	512,55	557,87	727,34
1140140- W. 1400H. 650	524,68	552,23	633,09	792,23
1140160- W. 1600H. 650	564,57	591,28	680,96	903,51
1140180- W. 1800H. 650	629,79	664,15	738,40	987,23
1140200- W. 2000H. 650	677,66	722,98	806,70	1081,38

ScreenIT A30 with built in rail 800 mm, white

With seam				
1170080- W. 800 H. 800	385,74	393,94	582,87	767,45
1170120- W. 1200 H. 800	477,13	508,40	635,96	835,53
1170140- W. 1400 H. 800	524,26	540,85	800,53	1035,53
1170160- W. 1600 H. 800	606,17	618,83	978,40	1317,23
1170180- W. 1800 H. 800	655,96	668,51	1081,17	1471,70
1170200- W. 2000 H. 800	718,51	732,98	1197,02	1652,34
With zip				
1170080- W. 800 H. 800	429,26	438,19	623,72	810,21
1170120- W. 1200H. 800	520,96	552,45	676,49	877,98
1170140- W. 1400H. 800	567,66	584,79	841,28	1077,98
1170160- W. 1600H. 800	649,89	662,98	1019,15	1359,57
1170180- W. 1800H. 800	699,57	712,55	1121,91	1514,15
1170200- W. 2000H. 800	762,45	777,02	1237,87	1695,00

ScreenIT A40 with built in rail 650 mm, white

A40 with seam				
1145080- W. 800 H. 650	358,19	379,57	430,32	523,51
1145120- W. 1200H. 650	460,96	482,55	532,55	705,53
1145140- W. 1400H. 650	495,53	523,90	610,21	772,34
1145160- W. 1600H. 650	536,70	563,40	659,36	886,81
1145180- W. 1800H. 650	603,72	638,40	718,51	973,19
1145200- W. 2000H. 650	652,87	699,26	788,94	1070,32
A40 with zip				
1145080- W. 800 H. 650	401,81	423,72	471,06	566,17
1145120- W. 1200 H. 650	504,57	526,60	573,62	747,87
1145140- W. 1400 H. 650	539,04	567,55	650,96	814,79
1145160- W. 1600 H. 650	580,43	607,45	700,11	929,26
1145180- W. 1800 H. 650	647,55	682,77	759,26	1015,43
1145200- W. 2000 H. 650	696,70	743,51	829,68	1112,55



ScreenIT A40 with built in rail 800 mm, white

With seam				
1180080- W. 800 H. 800	397,13	405,74	600,53	790,74
1180120- W. 1200H. 800	491,60	523,62	654,89	860,64
1180140- W. 1400H. 800	540,00	557,13	824,47	1066,60
1180160- W. 1600H. 800	624,36	637,55	1007,77	1356,81
1180180- W. 1800H. 800	675,53	688,40	1113,51	1515,85
1180200- W. 2000H. 800	740,21	754,89	1232,87	1702,13
With zip				
1180080- W. 800 H. 800	440,85	450,11	641,28	833,19
1180120- W. 1200H. 800	535,21	567,87	695,43	903,19
1180140- W. 1400H. 800	583,62	601,28	865,21	1109,04
1180160- W. 1600H. 800	668,19	681,60	1048,51	1399,15
1180180- W. 1800H. 800	719,26	732,45	1154,36	1558,30
1180200- W. 2000H. 800	783,94	798,94	1273,83	1744,47

Order procedure desk screen, see page 27.

The brackets below fit the above items.
See all mounts on pages 22-25.



641020 642034 642075
641057 642085



AT40 is a sound dampening desk screen. AT = Absorption and Transmission. The screen has a solid core and with a 10 mm A-classed sound absorbent on each side, covered by a foam laminated textile of your choice. Total thickness 40 mm. AT40 is also available with height 800 mm. Contact Gotessons for article number and price.

SCREENIT AT40

ScreenIT AT40

See price ranges in textile chapter.

With seam	Pricer. 1	Pricer. 2	Pricer. 3	Pricer. 4
626080- W. 800 H. 650	217,55	248,40	367,98	474,79
626120- W. 1200 H. 650	293,72	343,09	439,15	548,72
626140- W. 1400 H. 650	324,47	378,62	467,34	578,40
626160- W. 1600 H. 650	365,96	426,49	506,38	618,94
626180- W. 1800 H. 650	399,04	466,06	537,34	650,85
626200- W. 2000 H. 650	436,91	510,32	572,55	687,77
With zip	Pricer. 1	Pricer. 2	Pricer. 3	Pricer. 4
626080- W. 800 H. 650	263,09	294,36	410,43	518,94
626120- W. 1200 H. 650	339,26	389,26	481,60	593,09
626140- W. 1400 H. 650	369,47	424,57	509,89	622,55
626160- W. 1600 H. 650	411,49	472,45	548,72	662,87
626180- W. 1800 H. 650	444,68	512,13	579,89	695,21
626200- W. 2000 H. 650	482,34	556,28	615,00	732,02

Order procedure desk screen, see page 27.

Facts: Standard height from desk top 450 mm with clamp.
With desk mount 430 mm if desk is 20 mm. Max load 6 kg.

The brackets below fit the above items.

See all mounts on pages 22-25.

(A)	(B)	(E)	(F)	(G)	(X)	(EE)	(UU)
641010	641025	643047	643046	641020	642036	642075	643015
641056	641035			641057		642085	643016



A smaller AT40 desk screen that is easy to place above desk with a special made desk mount. Also as dividing screens in bench systems, see page 37+39 or www.gotessons.com.

SCREENIT AT40 ABOVE DESK

ScreenIT AT40 above desk

See price ranges in textile chapter.

With seam	Pricer. 1	Pricer. 2	Pricer. 3	Pricer. 4
621760- W. 760 H. 450	210,85	245,85	252,98	334,36
626800- W. 800 H. 450	218,51	249,68	272,77	340,74
621200- W. 1200H. 450	260,21	297,77	367,98	439,79
621400- W. 1400H. 450	295,43	337,55	418,09	492,13
621600- W. 1600H. 450	315,74	361,49	441,38	515,96
621800- W. 1800H. 450	362,23	414,15	482,02	558,40
622000- W. 2000H. 450	404,15	462,34	546,70	625,53
With zip	Pricer. 1	Pricer. 2	Pricer. 3	Pricer. 4
621760- W. 760 H. 450	256,06	291,49	295,32	378,19
626800- W. 800 H. 450	264,04	295,53	315,21	384,68
621200- W. 1200H. 450	305,64	338,19	410,43	483,94
621400- W. 1400H. 450	341,06	383,19	460,74	536,28
621600- W. 1600H. 450	361,28	411,81	483,72	560,43
621800- W. 1800H. 450	407,87	466,28	524,57	602,55
622000- W. 2000H. 450	449,68	515,32	589,15	669,89

Clamp AT40 above desk

For up to 22 mm desks, 2 pcs in one pack.

642050-1 white -2 black -3 silver 55.21/2 pcs

Clamp AT40 above desk longer than 1800 mm

For up to 22 mm desks, 3 pcs in one pack.

642070-1 white -2 black -3 silver 82.66/3 pcs

Clamp AT40 above desk

For up to 50 mm desks, 2 pcs in one pack.

642060-1 white -2 black -3 silver 55.21/2 pcs

Clamp AT40 above desk longer than 1800 mm

For up to 50 mm desks, 3 pcs in one pack.

642080-1 white -2 black -3 silver 82.66/3 pcs





ACCESSORIES FOR SCREENS

Flexible plexitop for shielding between working stations. The smoked plexitop limits certain sundrop, easy to move around. Can be placed on any A30 screens to increase height.

Plexitop 8 mm

451080	W. 800	H. 250	D. 8	transparent	107.66
451100	W. 1000	H. 250	D. 8	transparent	130.00
451120	W. 1200	H. 250	D. 8	transparent	143.09
451140	W. 1400	H. 250	D. 8	transparent	156.28
451160	W. 1600	H. 250	D. 8	transparent	169.15
451180	W. 1800	H. 250	D. 8	transparent	182.55
451200	W. 2000	H. 250	D. 8	transparent	195.64
452080	W. 800	H. 250	D. 8	frosted	123.40
452100	W. 1000	H. 250	D. 8	frosted	149.57
452120	W. 1200	H. 250	D. 8	frosted	169.15
452140	W. 1400	H. 250	D. 8	frosted	182.55
452160	W. 1600	H. 250	D. 8	frosted	195.64
452180	W. 1800	H. 250	D. 8	frosted	228.51
452200	W. 2000	H. 250	D. 8	frosted	248.09
453080	W. 800	H. 250	D. 8	smoked	156.28
453100	W. 1000	H. 250	D. 8	smoked	182.55
453120	W. 1200	H. 250	D. 8	smoked	208.83
453140	W. 1400	H. 250	D. 8	smoked	234.89
453160	W. 1600	H. 250	D. 8	smoked	261.28
453180	W. 1800	H. 250	D. 8	smoked	287.66
453200	W. 2000	H. 250	D. 8	smoked	313.83



Clamp for Plexitop

Suitable for ScreenIT A30. 2 pcs in one pack.

642074-1 white -2 black

58.94/2pcs

Clamp for Plexitop longer than 1600 mm

Suitable for ScreenIT A30. 3 pcs in one pack.

642076-1 white -2 black

99.57/3pcs

Adjustable desk clamp for Plexitop, 18-26 mm

Fits ScreenIT AT40 and Standard Reinforced.

643041-1 white -2 black -3 silver

79.04/2pcs

643042-1 white -2 black -3 silver For top wider than 1600 mm 115.96/3pcs

Adjustable desk clamp for Plexitop, 26-41 mm

Fits ScreenIT A30 and ScreenIT A40.

643043-1 white -2 black -3 silver

79.04/2pcs

643044-1 white -2 black -3 silver For top wider than 1600 mm 115.96/3pcs

Flexible plexitop for shielding between working stations. The smoked plexitop limits certain sundrop, easy to move around. Can be placed on any A30 screens to increase height.





TOOLBAR LIGHT

Add a Toolbar Light to any our of rails - good lighting creates a better work environment. Hold down the on/off button to dim the light to the right strength for you and your work.



Toolbar Light for rail

Cable length 1,90 m with USB contact at the end. Net adapter for wall socket included.

Watt: 4,5W.

Lumen max: 540 lm.

Colour temp: 4000K.

LUX max: 520lx at a height of 60 cm.

Beam angle: 95°.

821060-1

white

253.51

821060-3

silver

253.51



A30 LIGHT

Lamp with screen mount for A30 screen. Add an A30 Light to your A30 screen - good lighting creates a better working environment. Hold down the on/off button to dim the light to the right brightness for you and your work tasks.

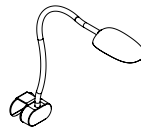

A30 Light

Dimmable LED for mounting on A30 screen.

Watt: 4,5W.

Lumens max: 540Lm.

Colour temp: 4000K.

LUX max: 520lx at a height of 60 cm.

Lighting angle: 95 °.

637135-1

white

242.13

637135-3

silver

242.13



TULIP



Tulip Desk Lamp LED

Desk lamp with USB charger. Has an unearthed plug with 1,9 m cable.

821005

white/black

128.40



Tray for Tulip for Freewall

W. 172 H. 190 D. 30

671087-1

white

48.09

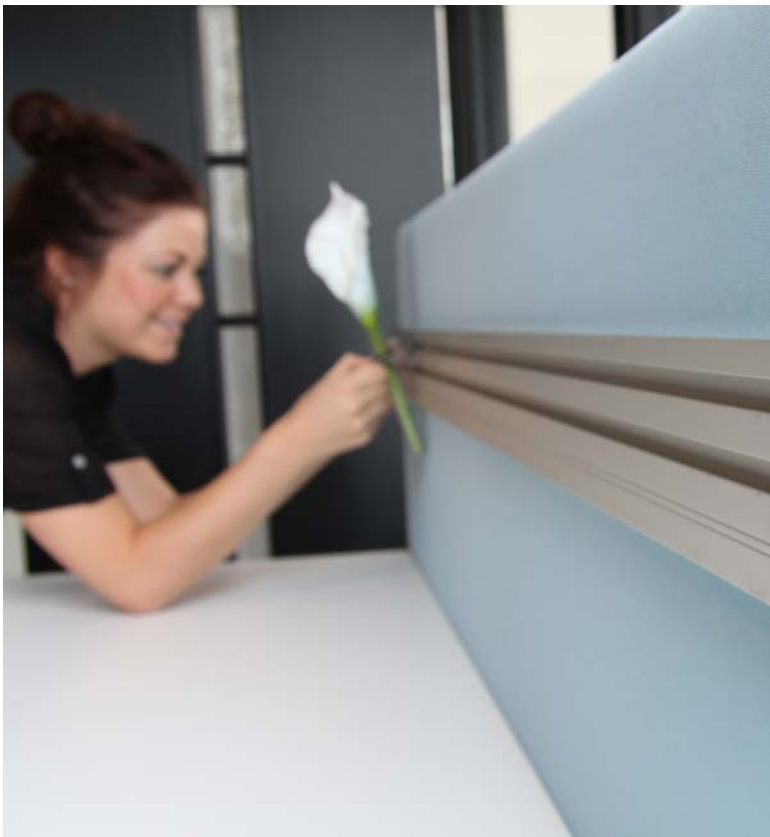

The toolbar that suits all accessories. It has a double profile concealing the attachment screws. Recommended mounting height: 310 mm above desk to top of the Freewall.

FREEWALL



Freewall double track
Suitable for ScreenIT Standard, A30/A40 Reinforced and wallmount
Extruded aluminium rail, 2 end covers and screws included.

676075	L. 750	H. 80	D. 16	silver	58.72
676075-1	L. 750	H. 80	D. 16	white*	64.26
676115	L. 1150	H. 80	D. 16	silver	74.15
676115-1	L. 1150	H. 80	D. 16	white*	81.49
676135	L. 1350	H. 80	D. 16	silver	82.23
676135-1	L. 1350	H. 80	D. 16	white*	90.11
676155	L. 1550	H. 80	D. 16	silver	89.79
676155-1	L. 1550	H. 80	D. 16	white*	99.04
676175	L. 1750	H. 80	D. 16	silver	98.09
676175-1	L. 1750	H. 80	D. 16	white*	107.87
676195	L. 1950	H. 80	D. 16	silver	105.85
676195-1	L. 1950	H. 80	D. 16	white*	116.38



The toolbar can be screwed on a desk screen or to a wall. Recommended mounting height: 310 mm above desk to top of the Freewall. The Freewall toolbar can also be fixed directly on the wall or other solid vertical surfaces.



Freewall
Suitable for ScreenIT Standard and wallmount.

Extruded aluminium rail, 2 end covers and screws included. Max load 6 kg/ ScreenIT Standard, Max load 25 kg ScreenIT Standard reinforced. Max load for wall depends on the wall's material.

670075	L. 750	H. 60	D. 14	silver	43.09
670075-1	L. 750	H. 60	D. 14	white*	47.77
670115	L. 1150	H. 60	D. 14	silver	60.43
670115-1	L. 1150	H. 60	D. 14	white*	66.28
670135	L. 1350	H. 60	D. 14	silver	67.98
670135-1	L. 1350	H. 60	D. 14	white*	74.57
670155	L. 1550	H. 60	D. 14	silver	76.06
670155-1	L. 1550	H. 60	D. 14	white*	83.72
670175	L. 1750	H. 60	D. 14	silver	83.62
670175-1	L. 1750	H. 60	D. 14	white*	92.02
670195	L. 1950	H. 60	D. 14	silver	94.89
670195-1	L. 1950	H. 60	D. 14	white*	104.26



Freewall
Suitable for ScreenIT A30/A40 Reinforced desk screen

Extruded aluminium rail, 2 end covers and screws included. Height 60 mm, width 14 mm. Max load 25 kg.

671075	L. 750	H. 60	D. 14	silver	43.09
671075-1	L. 750	H. 60	D. 14	white*	47.77
671115	L. 1150	H. 60	D. 14	silver	60.43
671115-1	L. 1150	H. 60	D. 14	white*	66.28
671135	L. 1350	H. 60	D. 14	silver	67.98
671135-1	L. 1350	H. 60	D. 14	white*	74.57
671155	L. 1550	H. 60	D. 14	silver	76.06
671155-1	L. 1550	H. 60	D. 14	white*	83.72
671175	L. 1750	H. 60	D. 14	silver	83.62
671175-1	L. 1750	H. 60	D. 14	white*	92.02
671195	L. 1950	H. 60	D. 14	silver	94.89
671195-1	L. 1950	H. 60	D. 14	white*	104.26

Delivery time 5-10 days.



Posts and arms are made of extruded aluminium. The attachments are casted in aluminium or laser cut sheet. Rail length, see www.gotessons.com.

LINJÉ 4WAY TOOLBAR

Creating a stable third level allows for more workspace and is ideal when working with multiple monitors. Max load 100 kg. Select required accessories shown on page 41-45.



Linjé 4way Toolbar

Toolbar rail with 2x400 mm posts, 2 desk clamps.
For desk max 45 mm.

692140	1400 mm Clamp set	silver	380.85
692140-1	1400 mm Clamp set	white*	418.83
692160	1600 mm Clamp set	silver	397.34
692160-1	1600 mm Clamp set	white*	437.02
692180	1800 mm Clamp set	silver	414.04
692180-1	1800 mm Clamp set	white*	455.43

Linjé 4Way Toolbar

As shown on all pictures the Clamp small are more discreet.
For up to 42 mm desks.

694140	1400 mm clamp small	silver	380.85
694140-1	1400 mm clamp small	white*	418.83
694160	1600 mm clamp small	silver	397.34
694160-1	1600 mm clamp small	white*	437.02
694180	1800 mm clamp small	silver	414.04
694180-1	1800 mm clamp small	white*	455.43

Linjé 4Way Toolbar

Toolbar rail with 2x400 mm posts, 2 desk mounts.

693140	1400 mm Desk mount set	silver	380.85
693140-1	1400 mm Desk mount set	white*	418.83
693160	1600 mm Desk mount set	silver	397.34
693160-1	1600 mm Desk mount set	white*	437.02
693180	1800 mm Desk mount set	silver	414.04
693180-1	1800 mm Desk mount set	white*	455.43

Delivery time 5-10 days.



TOOLBAR ARMS



ZAP Toolbar 3

Incl. toolmount. Weight span 1,5-7 kg.
L. 505 H. 399

616525	silver	246.28
616525-1	white	246.28
616525-2	black	246.28



D-Zine Toolbar 1

Max weight 12 kg.
L. 130 H. 135

611525	silver	107.02
611525-1	white	107.02
611525-2	black	107.02



D-Zine Toolbar 2

Max weight 12 kg.
L. 315 H. 135

611526	silver	153.51
611526-1	white	153.51
611526-2	black	153.51



D-Zine Toolbar 3

Gas arm. Incl. toolmount. Weight span 1,5-8,5 kg.
L. 470 H. 360

611325	silver	193.94
611325-1	white	193.94
611325-2	black	193.94

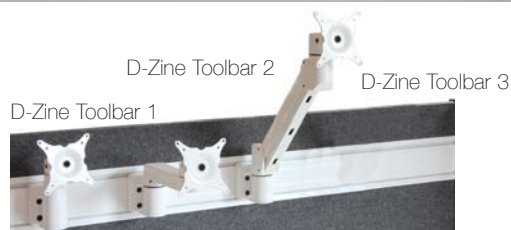



Desk screen made of acrylic. The screens are available in transparent, frosted and smoked plexi.

SCREENIT PLEXI

ScreenIT Plexi 5 mm

5 mm thick acryl desk screen. Standard height from desk top 450 mm (with desk clamp).

631080	W. 800	H. 650	transparent	143.09
631120	W. 1200	H. 650	transparent	189.15
631140	W. 1400	H. 650	transparent	228.51
631160	W. 1600	H. 650	transparent	241.60
631180	W. 1800	H. 650	transparent	261.28
633080	W. 800	H. 650	frosted	162.87
633120	W. 1200	H. 650	frosted	221.91
633140	W. 1400	H. 650	frosted	254.68
633160	W. 1600	H. 650	frosted	280.85
633180	W. 1800	H. 650	frosted	313.83
635080	W. 800	H. 650	smoked	215.21
635120	W. 1200	H. 650	smoked	294.15
635140	W. 1400	H. 650	smoked	340.00
635160	W. 1600	H. 650	smoked	379.47
635180	W. 1800	H. 650	smoked	418.83

ScreenIT Plexi 8 mm

8 mm thick acryl desk screen. Standard height from desk top 450 mm (with desk clamp).

637080	W. 800	H. 650	transparent	208.83
637120	W. 1200	H. 650	transparent	280.85
637140	W. 1400	H. 650	transparent	320.32
637160	W. 1600	H. 650	transparent	340.00
637180	W. 1800	H. 650	transparent	372.87
638080	W. 800	H. 650	frosted	234.89
638120	W. 1200	H. 650	frosted	326.81
638140	W. 1400	H. 650	frosted	392.55
638160	W. 1600	H. 650	frosted	412.13
638180	W. 1800	H. 650	frosted	464.68
639080	W. 800	H. 650	smoked	307.13
639120	W. 1200	H. 650	smoked	438.51
639140	W. 1400	H. 650	smoked	497.55
639160	W. 1600	H. 650	smoked	563.09
639180	W. 1800	H. 650	smoked	615.64



Transparent



Frosted



Smoked

Clamp set for ScreenIT Plexi, 2 pcs

For up to 42 mm desks. 2 pcs in one pack.

641080-1white	-2 black	-3 silver	57.02/2pcs
---------------	----------	-----------	------------



Clamp set for ScreenIT Plexi longer than 1600 mm

For up to 42 mm desks, 3 pcs in one pack.

641081-1white	-2 black	-3 silver	86.06/3pcs
---------------	----------	-----------	------------

Desk mount for ScreenIT Plexi

To be mounted with screws under the desk, 2 pcs in one pack.

641082-1white	-2 black	-3 silver	58.72/2pcs
---------------	----------	-----------	------------



Desk mount for ScreenIT Plexi longer than 1600 mm

To be mounted with screws under the desk, 3 pcs in one pack.

641083-1white	-2 black	-3 silver	88.72/3pcs
---------------	----------	-----------	------------

Desk mount set for Halfpipe with keyhole

To be mounted with screws under the desk, 2 pcs in one pack.

641084-1white	-3 silver	70.32/2pcs
---------------	-----------	------------



Desk mount set for Halfpipe with keyhole, for ScreenIT Plexi longer than 1600 mm

To be mounted with screws under the desk, 3 pcs in one pack.

641086-1white	-3 silver	94.68/3pcs
---------------	-----------	------------

Desk mount with recess for a beam for ScreenIT Plexi

To be mounted with screws under the desk, 2 pcs in one pack.

641087-1white	-2 black	-3 silver	62.34/2pcs
---------------	----------	-----------	------------



Desk mount with recess for a beam for ScreenIT Plexi longer than 1600 mm

To be mounted with screws under the desk, 3 pcs in one pack.

641088-1white	-2 black	-3 silver	86.91/3pcs
---------------	----------	-----------	------------



Booth dividers connected with zipper. Side screens width is as standard 800 mm. Not available with fishbone zip. Contact us for other measurements.



SCREENIT A30 BOOTH

ScreenIT A30 desk booth 650 mm *See price ranges in textile chapter.*

With seam+zip	Pricer. 1	Pricer. 2	Pricer. 3	Pricer. 4
855120- W. 1200 H. 650	764,04	812,23	1202,34	1512,55
855140- W. 1400 H. 650	770,85	819,15	1208,94	1519,26
855160- W. 1600 H. 650	773,72	822,02	1211,81	1522,13
855180- W. 1800 H. 650	809,26	857,98	1245,85	1557,87

ScreenIT A30 desk booth 800 mm







With seam+zip	Pricer. 1	Pricer. 2	Pricer. 3	Pricer. 4
1181120- W. 1200 H. 800	971,38	1012,23	1555,32	2148,19
1181140- W. 1400 H. 800	978,30	1045,64	1649,04	2244,36
1181160- W. 1600 H. 800	981,28	1077,66	1707,66	2313,62
1181180- W. 1800 H. 800	1017,23	1114,47	1783,19	2382,34

Order procedure desk screen, see page 27.

Facts: Desk thickness 20 mm applies to following measures.
Screens H:650 mm: Clamp = H:450 mm above desk.
Deskmount = H:430 mm above desk.
Screens H:800 mm: Clamp = H:600 mm above desk.
Deskmount = H:580 mm above desk.
Max load 6 kg. Total screen thickness 40 mm.

The brackets below fit the above items.

See all mounts on pages 22-25.

					
641068	641071	641069	642027	642075	642075
				642085	642085

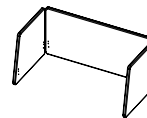

PEAK DESK SCREEN BOOTH

Peak Desk Screen booth 650 mm *See price ranges in textile chapter.*

With seam+zip	Pricer. 1	Pricer. 2	Pricer. 3	Pricer. 4
108120- W. 1200 H. 650	926,70	984,79	1179,47	1483,72
108140- W. 1400 H. 650	934,57	993,19	1185,96	1490,32
108160- W. 1600 H. 650	938,09	996,81	1188,72	1493,19
108180- W. 1800 H. 650	981,17	1040,32	1222,13	1527,98

Peak Desk Screen booth 800 mm







With seam+zip	Pricer. 1	Pricer. 2	Pricer. 3	Pricer. 4
109120- W. 1200 H. 800	1147,23	1251,28	1555,53	2148,19
109140- W. 1400 H. 800	1175,64	1292,45	1649,04	2244,36
109160- W. 1600 H. 800	1213,62	1332,13	1707,66	2313,62
109180- W. 1800 H. 800	1239,47	1377,55	1783,19	2382,34

Order procedure desk screen, see page 27.

Facts: Desk thickness 20 mm applies to following measures.
Screens H:650 mm: Clamp = H:450 mm above desk.
Deskmount = H:430 mm above desk.
Screens H:800 mm: Clamp = H:600 mm above desk.
Deskmount = H:580 mm above desk.
Max load 6 kg. Total screen thickness 40 mm.

The brackets below fit the above items.

See all mounts on pages 22-25.

					
641068	641071	641069	642027	642075	642075
				642085	642085

The desk version of our popular Peak Design Booth – slightly slanted side screens are combined with a straight front screen in order to create a dynamic pattern by your work space. Choose between height 650 mm or 800 mm and four different widths to suit your spaces. Side screens width is as standard 800 mm. Play around with different coloured booths or use one tone to create a room divider in your environments.



Screen mounted on the desk with clamp or with pins above or through the desk. Can also stand on top of the desk. Can not be loaded with accessories.

SCREENIT A30 ABOVE DESK

ScreenIT A30 above desk

See price ranges in textile chapter.

			Pricer. 1	Pricer. 2	Pricer. 3	Pricer. 4
With seam						
857076-	W. 760	H. 450	121,70	143,19	217,13	258,94
857080-	W. 800	H. 450	121,70	143,19	217,13	258,94
857120-	W. 1200	H. 450	185,85	224,79	259,57	365,00
857140-	W. 1400	H. 450	196,38	237,23	269,04	414,89
857160-	W. 1600	H. 450	206,38	248,83	389,15	467,87
857180-	W. 1800	H. 450	244,47	293,30	434,89	521,06
857200-	W. 2000	H. 450	292,87	350,11	486,28	586,91
With zip						
857076-	W. 760	H. 450	165,00	187,02	259,04	302,23
857080-	W. 800	H. 450	165,00	187,02	259,04	302,23
857120-	W. 1200	H. 450	229,15	268,72	301,38	408,51
857140-	W. 1400	H. 450	239,79	281,17	310,96	458,30
857160-	W. 1600	H. 450	249,57	292,66	430,96	511,38
857180-	W. 1800	H. 450	287,98	337,13	476,49	564,57
857200-	W. 2000	H. 450	336,49	394,04	527,98	630,53

Order procedure desk screen, see page 27.

The brackets below fit the above items.

See all mounts on pages 22-25.





 642090 642088 642095 642089 642093



Desk screen for dividing workspace above desk. Height is adapted to be combined with a desk screen mounted with clamps. Total thickness 40 mm. Can not be loaded with accessories.

SCREENIT A30 SIDESCREEN

ScreenIT A30 Sidescreen







See price ranges in textile chapter.

			Pricer. 1	Pricer. 2	Pricer. 3	Pricer. 4
With seam						
760450-	W. 760	H. 450	172,98	181,49	254,89	370,74
800450-	W. 800	H. 450	172,98	181,49	254,89	370,74
With zip						
760450-	W. 760	H. 450	187,98	201,38	275,00	394,79
800450-	W. 800	H. 450	187,98	201,38	275,00	394,79

Order procedure desk screen, see page 27.

The brackets below fit the above items.

See all mounts on pages 22-25.







 642068 642082 642083 643011 643012 643013

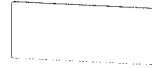

Silent Express is built with a wooden frame and a 30 mm sound absorbent. The screen is dressed in the unlaminated textile Cool, in one of our four colours below with a seam like the textile. Total thickness is 32 mm. Max load: 0 kg. Silent Express is a stocked screen.

SILENT EXPRESS



Silent Express

510080-90	W. 800	H. 650	beige	141.28
510120-90	W. 1200	H. 650	beige	174.04
510140-90	W. 1400	H. 650	beige	195.43
510160-90	W. 1600	H. 650	beige	209.04
510180-90	W. 1800	H. 650	beige	222.34

Silent Express

510080-91	W. 800	H. 650	light grey	141.28
510120-91	W. 1200	H. 650	light grey	174.04
510140-91	W. 1400	H. 650	light grey	195.43
510160-91	W. 1600	H. 650	light grey	209.04
510180-91	W. 1800	H. 650	light grey	222.34

Silent Express

510080-92	W. 800	H. 650	dark grey	141.28
510120-92	W. 1200	H. 650	dark grey	174.04
510140-92	W. 1400	H. 650	dark grey	195.43
510160-92	W. 1600	H. 650	dark grey	209.04
510180-92	W. 1800	H. 650	dark grey	222.34

Silent Express

510080-93	W. 800	H. 650	blue	141.28
510120-93	W. 1200	H. 650	blue	174.04
510140-93	W. 1400	H. 650	blue	195.43
510160-93	W. 1600	H. 650	blue	209.04
510180-93	W. 1800	H. 650	blue	222.34

Can only be chosen in the four colours from textile Cool below.

Can not be loaded with accessories. Total thickness 32 mm.

Desk thickness 20 mm applies to following measures.

Screens H:650 mm: Clamp = H. 450 mm above desk.

Desk mount = H. 430 mm above desk

The brackets below fit the above items.

See all mounts on pages 22-25.

(A)	(B)	(E)	(F)	(G)	(EE)	(JJ)
641010	641025	643047	643046	641020	642075 642085	643015 643016



Cool Beige



Cool Light grey

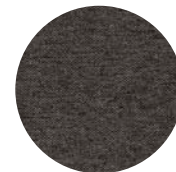

Cool Dark grey

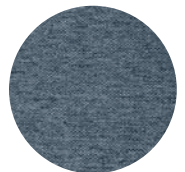

Cool Blue



Portable and foldable screens ideal for examinations, small workspaces and dividing large tables temporarily. 3 mm solid core dressed with foam laminated fabric. Total thickness: 13 mm.

FOLDIT

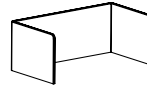

FoldIT

See price ranges in textile chapter.

	Pricer. 1	Pricer. 2	Pricer. 3	Pricer. 4
629500-	199,57	229,15	306,81	485,96
621160-	238,19	273,09	365,85	581,70
621470-	288,09	330,43	443,30	705,00

Measurements:

629500= W. 940 H. 410 D 520

621160= W. 1140 H. 410 D 620

621470= W. 1440 H. 410 D 720



Linking bracket FoldIT

To link screens together.

642072-2	black	14.68
----------	-------	-------

Order procedure desk screen, see page 27.

Note! Can only be ordered with seam. Outer measures specified. Thickness 13 mm.



Portable desk screen made of pressed felt with 100% recycled polyester fibres. Easy to fold and put away.

FOLDIT BASIC FELT

FoldIT Basic Felt

Made of pressed felt with 100% recycled polyester fibres.

621420	W. 500	H. 420	D. 400	dark grey	83.72
621420-1	W. 500	H. 420	D. 400	light grey	83.72
621820	W. 900	H. 420	D. 400	dark grey	90.74
621820-1	W. 900	H. 420	D. 400	light grey	90.74

Note! Outer measures specified. Thickness 9 mm.

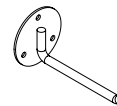

Wall hook FoldIT Basic Felt

With space for 10 FoldIT Basic Felt. W. 60 H. 60 D. 117

671077-1	white	-2 black	-3 silver	32.34
----------	-------	----------	-----------	-------



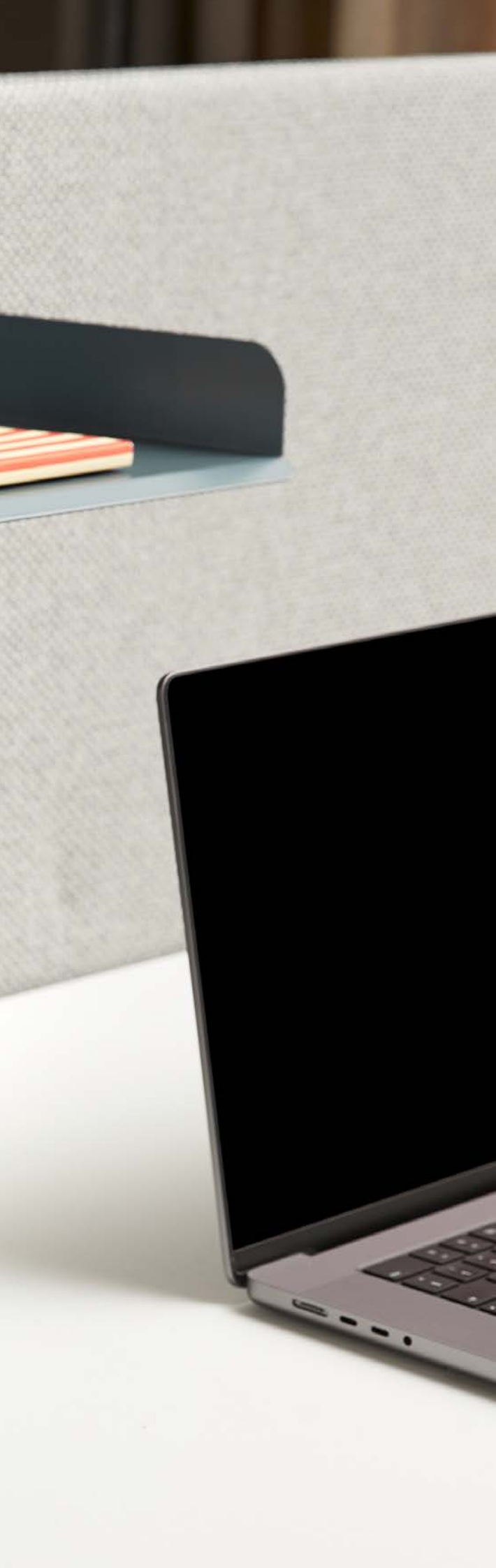

ACCESSORIES, TOOLBAR RAILS

Toolbars enable you to create a practical and efficient workstation. All accessories are within easy reach placed on a suspended third level, keeping the desk surface clear and usable.

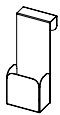

Pen holder ScreenIT A30 +

Pen tray in metal to hang over the screen.

W. 100 H. 250 D. 60

637200-1	white	50.96
637200-2	black	50.96
637200-21	green	50.96
637200-22	blue	50.96

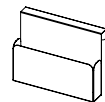

A4 tray ScreenIT A30 +

A4 tray in metal to hang over the screen.

W. 320 H. 250 D. 60

637201-1	white	67.34
637201-2	black	67.34
637201-21	green	67.34
637201-22	blue	67.34

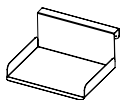

A4 shelf ScreenIT A30 +

A4-shelf in metal to hang over the screen.

W. 320 H. 158 D. 300

637202-1	white	65.21
637202-2	black	65.21
637202-21	green	65.21
637202-22	blue	65.21

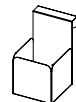

Pot ScreenIT A30 +

Pot in metal to hang over the screen.

W. 150 H. 250 D. 190

637203-1	white	68.51
637203-2	black	68.51
637203-21	green	68.51
637203-22	blue	68.51



Pen holder +
 Material: lacquered metal
 W. 80 H. 100 D. 80

637204-1	white	36.70
637204-2	black	36.70
637204-21	green	36.70
637204-22	blue	36.70



Pot +
 Material: Lacquered metal. Plants with a maximum outer diameter of 137 mm fit this pot.
 W. 140 H. 140 D. 140

637205-1	white	45.43
637205-2	black	45.43
637205-21	green	45.43
637205-22	blue	45.43

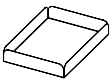

Tray +
 Material: lacquered metal.
 W. 230 H. 50 D. 320

637206-1	white	43.30
637206-2	black	43.30
637206-21	green	43.30
637206-22	blue	43.30

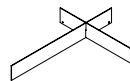

Tray divider +.
 Material: lacquered metal. Suits in Tray +. See picture above.
 W. 228 H. 40 D. 318

637207-1	white	32.34
637207-2	black	32.34
637207-21	green	32.34
637207-22	blue	32.34



POCKET



Pocket

Only fits ScreenIT A30 desk and floor screen. 2 smaller pockets, 1 larger pocket. Leather is always light beige; material: IMOLA. *

W. 280 H. 350 D. 40

637126

brown leather

125.32



LOOK



Look

Only fits ScreenIT A30 screens. Lacquer and MDF are always white. Leather is always light beige, material: IMOLA. *

W. 125 H. 290 D. 55

637127

white, brown leather

151.91

637132-1

white

118.51

*Imola= 50% Polyester, 30% Cotton, 20% recycled leather.



HOOK



Hook

Only fits A30 screens. Lacquer is always white. Leather is always light beige, material: IMOLA.*
 W. 40 H. 100 D. 95

637129	white, brown leather	52.45
637134-1	white	20.53

*Imola= 50% Polyester, 30% Cotton, 20% recycled leather.



HOOK



Hook for ScreenIT A30

Hook in metal to be hanged over the desk screen.
 W. 60 H. 101 D. 48

671098	silver	20.21
671098-1	white	20.21
671098-2	black	20.21

COMPARE SCREENS

PAGE SCREEN

30



SCREENIT FLEXIBLE

As ScreenIT A30 without holes. Can be used as a desk or floor screen or wall mounted.

52



SCREENIT A30 FLOOR SCREEN

Wooden frame filled with sound absorbing anti-allergy foam and lined with foam laminated textile. Total thickness 40 mm.

54



SCREENIT A30/A40 FLOOR SCREEN WITH STRAIGHT CORNER

Wooden frame filled with sound absorbing anti-allergy foam and lined with foam laminated textile. Straight corner. Thickness A40 50 mm.

55



THE RISING

A patented floor screen that you can raise and lower freely to the desired height. The screen is a ScreenIT A30.

56



SCREENIT A30 FLOOR SCREEN BOOTH BUILDABLE

The floor screens are zipped together to form a booth on adjustable feet. Material like ScreenIT A30.

57



A30 PEAK DESIGN BOOTH

Sound absorbing booth solution with a slight tilted side screen to create dynamics and openness. The booth is coupled with zipper and can therefore be built in infinity. Total thickness 40 mm.

Read more and compare our desk screens and desk screen booths in the Desk Screen Chapter.

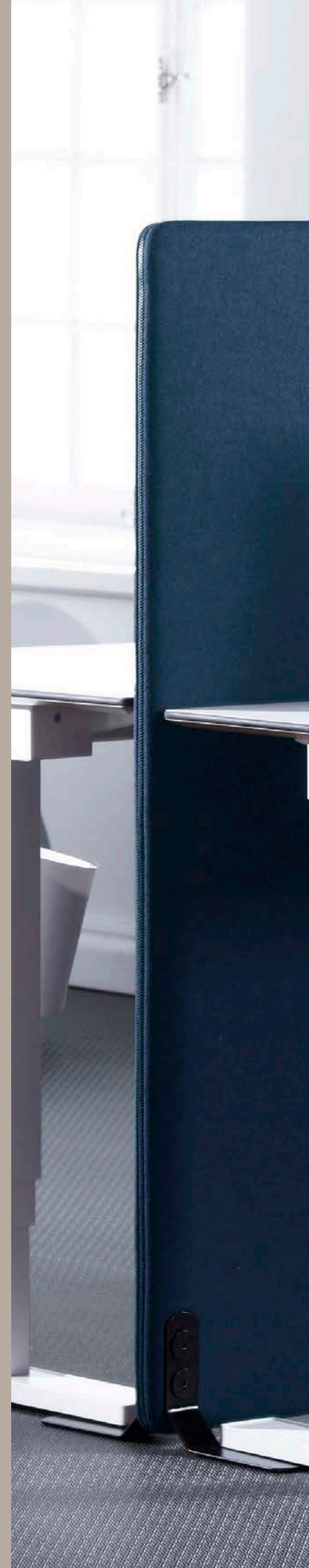

FLOOR SCREENS AND FLOOR SCREEN BOOTHS

In today's open office landscapes, floor screens can make the difference needed for the working climate. Screens that create rooms within the room, screens that take care of noise and buzz from office machines, writing on keyboards and talking colleagues. Everything from flexible screens to room dividers and booths can be found on these pages.

ORDER PROCEDURE

FLOOR SCREEN

1. SELECT SCREEN AND SCREEN SIZE
2. SELECT TEXTILE COLOUR
See colour map at page 6-16.
3. SELECT ZIP OR SEAM COLOUR
See colours on page 17.
4. SELECT CLAMPS OR MOUNTS
See page 22-25.

Specify the article number as follows: Desk screen size - textile colour - zip/seam colour.
Example: 644140 - 01 - 101
Colour code within the parenthesis is the textile producer's own colour code, is not used for orders.

FLOOR SCREEN BOOTHS

1. SELECT SCREEN AND SCREEN SIZE
2. SELECT TEXTILE COLOUR
See colour map at page 6-16.
3. SELECT SEAM COLOUR
See colours on page 17.
4. SELECT ZIP TO CONNECT SCREENS
See page 17.
5. SELECT CLAMPS OR MOUNTS
See page 22-25.

Specify the article number as follows: Screen booth - textile colour - seam colour - zip colour.
Example: 1178160 - 14 - 206 - 101
Colour code within the parenthesis is the textile producer's own colour code, is not used for orders.

Below screens and textiles are Nordic Eco labeled in combination with each other.

SCREENS

ScreenIT A30 Floor Screen booth

TEXTILES

Event Screen +
Mica
Xpress
Cara
Rivet
Twist
Bond
Synergy
Remix 3





A30 Floor screen provides a stable, stylish and practical shielding in open plan areas.
Total thickness 40 mm.



* For screens with a width over 1200 mm, we might add a decor seam when the textile width is not sufficient. Contact Gotessons if you have any questions.

SCREENIT A30 FLOOR SCREEN

ScreenIT A30 floor screen

See price ranges in textile chapter.

With seam			Pricer. 1	Pricer. 2	Pricer. 3	Pricer. 4
632120-	W. 800	H. 1200	274,79	337,13	507,87	702,66
632140-	W. 800	H. 1400	303,94	372,13	603,30	802,13
632160-	W. 800	H. 1600	332,66	406,28	672,02	873,30
632180-	W. 800	H. 1800	361,91	444,26	740,32	944,68
634120-	W. 1000	H. 1200	347,23	412,02	577,55	775,21
634140-	W. 1000	H. 1400	376,17	431,70	618,94	818,19
634160-	W. 1000	H. 1600	390,74	448,19	700,64	903,30
634180-	W. 1000	H. 1800	488,83	563,30	754,79	946,28
636120-	W. 1200	H. 1200	354,68	471,81	584,47	782,55
636140-	W. 1200	H. 1400	383,51	488,62	639,36	839,68
636160-	W. 1200	H. 1600	412,45	506,28	721,49	946,81
636180-	W. 1200	H. 1800	510,11	595,21	797,34	988,83
669120-	W. 1400	H. 1200	383,51	488,62	639,36	839,68
669140-*	W. 1400	H. 1400	435,74	535,11	877,87	1098,19
669160-*	W. 1400	H. 1600	477,87	570,00	962,34	1192,45
669180-*	W. 1400	H. 1800	542,77	667,23	1043,94	1286,38
653120-	W. 1600	H. 1200	434,36	512,55	742,55	946,81
653140-*	W. 1600	H. 1400	477,87	570,00	962,34	1192,45
653160-*	W. 1600	H. 1600	521,28	627,98	1037,23	1288,40
With zip			Pricer. 1	Pricer. 2	Pricer. 3	Pricer. 4
632120-	W. 800	H. 1200	318,40	381,28	549,79	746,28
632140-	W. 800	H. 1400	347,23	415,96	645,32	845,64
632160-	W. 800	H. 1600	376,17	450,43	713,62	917,02
632180-	W. 800	H. 1800	405,32	488,30	782,23	988,19
634120-	W. 1000	H. 1200	390,32	455,96	619,47	818,62
634140-	W. 1000	H. 1400	419,79	475,85	660,85	861,91
634160-	W. 1000	H. 1600	434,36	492,13	742,55	946,81
634180-	W. 1000	H. 1800	531,38	616,49	818,62	988,83
636120-	W. 1200	H. 1200	397,87	515,96	626,17	826,06
636140-	W. 1200	H. 1400	427,02	532,66	681,28	882,98
636160-	W. 1200	H. 1600	455,96	550,21	763,30	990,11
636180-	W. 1200	H. 1800	563,30	648,40	850,53	1010,11
669120-	W. 1400	H. 1200	427,02	532,66	681,28	882,98
669140-*	W. 1400	H. 1400	479,04	579,04	935,85	1157,98
669160-*	W. 1400	H. 1600	521,28	613,83	1020,11	1251,81
669180-*	W. 1400	H. 1800	586,28	710,96	1101,38	1345,11
653120-	W. 1600	H. 1200	477,87	556,38	784,36	990,11
653140-*	W. 1600	H. 1400	521,28	613,83	1020,11	1251,81
653160-*	W. 1600	H. 1600	564,79	671,70	1099,57	1352,13

Order procedure floor screen, see page 51.

For floor screen accessories, please see Toolbar chapter.

*Screens over 1200 mm ordered with textiles: Ally, Blazer, Bond, Era, Houston Reflect, Illusion, Kaiman, Lido, Noble lux, Remix 3, Rivet and Synergy will be with a decor seam.

Brackets for the above items. See all mounts on pages 22-25.



641040 641055 641066
643070

SCREENIT A30 COLLECT

ScreenIT A30 Collect Floor screen

See price ranges in textile chapter.

With seam			Pricer. 1	Pricer. 2	Pricer. 3	Pricer. 4
685120-	W. 800	H. 1200	274,79	337,13	507,87	702,66
685140-	W. 800	H. 1400	303,94	372,13	603,30	802,13
685160-	W. 800	H. 1600	332,66	406,28	672,02	873,30
685180-	W. 800	H. 1800	361,91	444,26	740,32	944,68
686120-	W. 1000	H. 1200	347,23	412,02	577,55	775,21
686140-	W. 1000	H. 1400	376,17	431,70	618,94	818,19
686160-	W. 1000	H. 1600	390,74	448,19	700,64	903,30
686180-	W. 1000	H. 1800	488,83	563,30	754,79	946,28
689120-	W. 1200	H. 1200	354,68	471,81	584,47	782,55
689140-	W. 1200	H. 1400	383,51	488,62	639,36	839,68
689160-	W. 1200	H. 1600	412,45	506,28	721,49	946,81
689180-	W. 1200	H. 1800	510,11	595,21	797,34	988,83
690120-	W. 1400	H. 1200	383,51	488,62	639,36	839,68
690140-*	W. 1400	H. 1400	435,74	535,11	877,87	1098,19
690160-*	W. 1400	H. 1600	477,87	570,00	962,34	1192,45
690180-*	W. 1400	H. 1800	542,77	667,23	1043,94	1286,38
691120-	W. 1600	H. 1200	434,36	512,55	742,55	946,81
691140-*	W. 1600	H. 1400	477,87	570,00	962,34	1192,45
691160-*	W. 1600	H. 1600	521,28	627,98	1037,23	1288,40
With zip						
685120-	W. 800	H. 1200	318,40	381,28	549,79	746,28
685140-	W. 800	H. 1400	347,23	415,96	645,32	845,64
685160-	W. 800	H. 1600	376,17	450,43	713,62	917,02
685180-	W. 800	H. 1800	405,32	488,30	782,23	988,19
686120-	W. 1000	H. 1200	390,32	455,96	619,47	818,62
686140-	W. 1000	H. 1400	419,79	475,85	660,85	861,91
686160-	W. 1000	H. 1600	434,36	492,13	742,55	946,81
686180-	W. 1000	H. 1800	531,38	616,49	818,62	988,83
689120-	W. 1200	H. 1200	397,87	515,96	626,17	826,06
689140-	W. 1200	H. 1400	427,02	532,66	681,28	882,98
689160-	W. 1200	H. 1600	455,96	550,21	763,30	990,11
689180-	W. 1200	H. 1800	563,30	648,40	850,53	1010,11
690120-	W. 1400	H. 1200	427,02	532,66	681,28	882,98
690140-*	W. 1400	H. 1400	479,04	579,04	935,85	1157,98
690160-*	W. 1400	H. 1600	521,28	613,83	1020,11	1251,81
690180-*	W. 1400	H. 1800	586,28	710,96	1101,38	1345,11
691120-	W. 1600	H. 1200	477,87	556,38	784,36	990,11
691140-*	W. 1600	H. 1400	521,28	613,83	1020,11	1251,81
691160-*	W. 1600	H. 1600	564,79	671,70	1099,57	1352,13

This screen is built like an A30, but has a different hole pattern for feet with wheels. This means that the screens can be placed next to each other to save space when they are not in use.

Order procedure floor screen, see page 51.

For floor screen accessories, please see Toolbar chapter.

*Screens over 1200 mm ordered with textiles: Ally, Blazer, Bond, Era, Houston Reflect, Illusion, Kaiman, Lido, Noble lux, Remix 3, Rivet and Synergy will be with a decor seam.

Brackets for the above items. See all mounts on pages 22-25.



641066 643067



A30/A40 straight corner is a stylish rectangular floor screen, a good sound absorber/room divider with a total thickness of A30=40 mm, A40=50 mm. Also available as desk screen.



QQ

Foot set Woodland for Floorscreen A30
Foot in molded wood with ash veneer and metal fittings that fit A30 floor screen. 4 feet included.

643068-1	white*/ash	257.98
643068-2	black*/ash	257.98
643068-3	silver*/ash	257.98

SS

Foot set Woodland with wheels for Floorscreen A30
Foot set in molded wood with ash veneer and metal fittings that fits A30 floor screen. 4 feet with wheels included. The wheels are lockable.

643067-1	white*/ash	335.43
643067-2	black*/ash	335.43
643067-3	silver*/ash	335.43

RR

Foot set Woodland for A40/Sketch Floorscreen
Foot in molded wood with ash veneer and metal fittings that fit Sketch / A40 floor screen. 4 feet included.

643066-1	white*/ash	257.98
643066-2	black*/ash	257.98
643066-3	silver*/ash	257.98

Colour indicates fittings.

TT

Foot Set Slide-in Woodland with wheels for A40/Sketch Floor screen
Foot set in molded wood with ash veneer and metal fittings that fits Sketch/A40 floor screen. 4 feet with wheels included. The wheels are lockable.

643065-1	white*/ash	335.43
643065-2	black*/ash	335.43
643065-3	silver*/ash	335.43

Colour indicates wheels and fittings.

SCREENIT A30 SCREEN STRAIGHT CORNERS

ScreenIT A30 straight corner floor screen

See price ranges in textile chapter.

A30 with seam	Pricer. 1	Pricer. 2	Pricer. 3	Pricer. 4
532120- W. 800 H. 1200	274,79	337,13	507,87	702,66
532140- W. 800 H. 1400	303,94	372,13	603,30	802,13
532160- W. 800 H. 1600	332,66	406,28	672,02	873,30
532180- W. 800 H. 1800	361,91	444,26	740,32	944,68
534120- W. 1000 H. 1200	347,23	412,02	577,55	775,21
534140- W. 1000 H. 1400	376,17	431,70	618,94	818,19
534160- W. 1000 H. 1600	390,74	448,19	700,64	903,30
536120- W. 1200 H. 1200	354,68	471,81	584,47	782,55
536140- W. 1200 H. 1400	383,51	488,62	639,36	839,68
536160- W. 1200 H. 1600	412,45	506,28	721,49	946,81
569120- W. 1400 H. 1200	383,51	488,62	639,36	839,68
569140-*W. 1400 H. 1400	435,74	535,11	877,87	1098,19
569160-*W. 1400 H. 1600	477,87	570,00	962,34	1192,45
569180-*W. 1400 H. 1800	542,77	667,23	1043,94	1286,38
553120- W. 1600 H. 1200	434,36	512,55	742,55	946,81
553140-*W. 1600 H. 1400	477,87	570,00	962,34	1192,45
553160-*W. 1600 H. 1600	521,28	627,98	1037,23	1288,40

Order procedure floor screen, see page 53.

The brackets below fit the above items.

See all mounts on pages 22-25.



641040 641055 641066
643070

SCREENIT A40 FLOOR SCREEN STRAIGHT CORNER

ScreenIT A40 floorscreen straight corner

See price ranges in textile chapter.

A40 with seam	Pricer. 1	Pricer. 2	Pricer. 3	Pricer. 4
537120- W. 800 H. 1200	291,60	357,66	523,19	724,15
537140- W. 800 H. 1400	322,34	394,68	621,49	826,28
537160- W. 800 H. 1600	353,19	430,96	692,13	899,57
537180- W. 800 H. 1800	383,62	471,49	762,55	973,09
533120- W. 1000 H. 1200	368,51	437,23	594,89	798,51
533140- W. 1000 H. 1400	399,26	458,09	637,55	842,87
533160- W. 1000 H. 1600	414,36	475,64	721,60	930,21
555120- W. 1200 H. 1200	376,06	500,74	601,91	805,85
555140- W. 1200 H. 1400	406,81	518,51	658,72	864,89
555160- W. 1200 H. 1600	437,66	536,91	743,19	975,32
554120- W. 1400 H. 1200	406,81	518,51	658,72	864,89
554140-*W. 1400 H. 1400	462,34	567,87	904,15	1131,17
554160-*W. 1400 H. 1600	506,91	604,57	991,17	1228,40
554180-*W. 1400 H. 1800	575,96	707,87	1075,11	1324,89
557120- W. 1600 H. 1200	460,85	543,62	764,68	975,32
557140-*W. 1600 H. 1400	506,91	604,57	991,17	1228,40
557160-*W. 1600 H. 1600	552,98	665,96	1068,51	1327,02

Order procedure floor screen, see page 51.

Foot set for A40 Floor screen

4 in one pack. About 25 mm between the floor and the bottom of the floor screen.

642015-1	white -2 black -3 silver	76.81
----------	--------------------------	-------

Foot set Big for A40 Floor screen

4 in one pack. About 60 mm between the floor and the bottom of the floor screen.

643075-1	white -2 black -3 silver	76.81
----------	--------------------------	-------

Corner foot set support for angled screens, A40

4 in one pack. 3 standard and 1 angle.

642035-1	white -2 black -3 silver	76.81
----------	--------------------------	-------

Foot set with wheels for A40 Floor screen

Lockable wheels. 4 in one pack. About 45 mm between the floor and the bottom of the floor screen.

641067-1	white -2 black -3 silver	136.06
----------	--------------------------	--------

*Screens over 1200 mm ordered with textiles: Ally, Blazer, Bond, Era, Houston Reflect, Illusion, Kaiman, Lido, Noble lux, Remix 3, Rivet and Synergy will be with a decor seam.

Link fittings ScreenIT A30 Floor screen two-ways

641051-1	white -2 black -3 silver	22.02/pc
----------	--------------------------	----------

Link fittings ScreenIT A30 Floor screen two-ways angle

641052-1	white -2 black -3 silver	29.57/pc
----------	--------------------------	----------

Link fittings ScreenIT A30 Floor screen three ways angle

641053-1	white -2 black -3 silver	32.77/pc
----------	--------------------------	----------

Link fittings ScreenIT A30 Floor screen four ways angle

641054-1	white -2 black -3 silver	41.70/pc
----------	--------------------------	----------

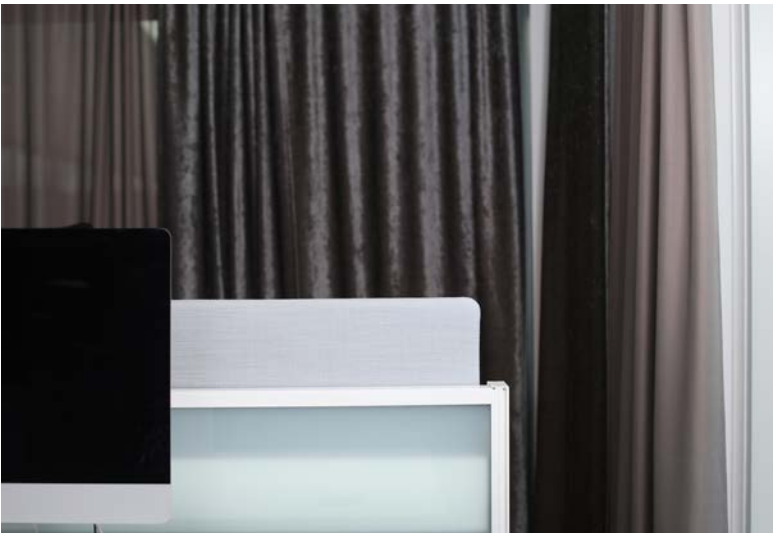

PATENTED THE RISING



SCREENIT A30 THE RISING

A floor screen that you can raise and lower freely to the desired height, 1100-1800 mm. Ideal in a classic desktop environment when you easily and quickly want to work undisturbed and in an open landscape to change the layout of the room. The Rising is Patented. See film on gotessons.com.

ScreenIT A30 The Rising

See price ranges in textile chapter.

		Pricer. 1	Pricer. 2	Pricer. 3	Pricer. 4
With seam					
641400-	W. 1300 H. 1010	355,96	424,89	548,62	748,09
641600-	W. 1500 H. 1010	410,21	444,15	719,36	1002,02
641800-	W. 1700 H. 1010	481,49	590,43	793,62	1108,40
With zip					
641400-	W. 1300 H. 1010	379,79	442,45	573,51	775,43
641600-	W. 1500 H. 1010	431,81	471,17	746,28	1032,02
641800-	W. 1700 H. 1010	510,53	619,89	823,09	1140,85

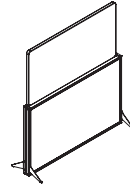

Stand for The Rising, frosted

Width: 1400 mm. Suitable for screen 1300 mm.

661400-1 white -2 black 2216.91

Stand for The Rising, frosted

Width: 1600 mm. Suitable for screen 1500 mm.

661600-1 white -2 black 2392.13

Stand for The Rising, frosted

Width: 1800 mm. Suitable for screen 1700 mm.

661800-1 white -2 black 2537.87

Stand for The Rising, smoked

Width: 1400 mm. Suitable for screen 1300 mm.

671400-1 white -2 black 2216.91

Stand for The Rising, smoked

Width: 1600 mm. Suitable for screen 1500 mm.

671600-1 white -2 black 2392.13

Stand for The Rising, smoked

Width: 1800 mm. Suitable for screen 1700 mm.

671800-1 white -2 black 2537.87

Foot set for The Rising

4 pcs in a pack, 2 pcs left and 2 pcs right. 0-40 mm between floor and bottom edge of floor screen.

648000-1 white -2 black 295.96



SUPPLEMENTS FOR THE RISING

Corner profile for The Rising

To connecting stands together in an angle.

648020-1 white -2 black 306.28



Foot set for The Rising

To connecting stands together with a corner profile. 2 in a pack: 1 pc left and 1 pc right.

648010-1 white -2 black 148.19



Order procedure for The Rising

1: Choose size and colour for the screen.

Specify the article number for the screen as follow:

Ex. 641600-01-101 Size on screen - colour of textile - colour of zip or seam.

2: Choose colour and glass for the stand.

3: Choose colour for Foot Set.

4: Add a corner profile if placed in an angle or in a row.

Facts: Measurement: adjustable height 1100-1800 mm.

Total thickness of absorbent 40 mm. When placing screens in an angle, use the corner profile for connecting stands and complete with 2 pack foot set.



SCREENIT A30 BOOTH

ScreenIT A30 Booth Buildable

See price ranges in textile chapter.

Booth two desks black feet	Pricer. 1	Pricer. 2	Pricer. 3	Pricer. 4
1161140-* W. 1400 H. 1400	2062,87	2313,72	2823,51	3775,96
1161160-* W. 1600 H. 1400	2126,38	2381,91	2912,55	3902,45
1161180-* W. 1800 H. 1400	2187,23	2449,68	3000,96	4028,09

Booth four desks black feet	Pricer. 1	Pricer. 2	Pricer. 3	Pricer. 4
1162140-* W. 1400 H. 1400	3364,89	3761,60	4595,21	6144,68
1162160-* W. 1600 H. 1400	3486,81	3899,15	4745,21	6390,21
1162180-* W. 1800 H. 1400	3603,62	4034,89	4932,13	6667,98

Order procedure floor screen, see page 51.

Important information: Inner dimensions. Mounted feet included.
 Can only be ordered with seam. Zipper is only used to connect screens.
 Not available with fishbone zip. Grommet in black.
 Silver and white as special.

With a double zip on both sides the booth can be increased in length as depicted.

Pricelist height is 1400 mm and side screens' width is 900 mm.
 For other sizes, please contact Gotessons.

For floor screen accessories, please see Toolbar chapter.

*Screens over 1200 mm ordered with textiles: Ally, Blazer, Bond, Era, Houston Reflect, Illusion, Kaiman, Lido, Noble lux, Remix 3, Rivet and Synergy and Illusion will be with a decor seam.



The floor screens are zipped together to form a booth on adjustable feet. Pricelist height is 1400 mm and the side screen's width is 800 mm. Feet are included. The booth screens are with a seam. The zipper is to connect the screens together. Not available with fishbone zip. For other sizes, request a quote.



Peak Design Booth is a booth solution with a slight tilted side screen to create dynamics and openness. The booth is coupled with zipper and can therefore be built in infinity. The height is as standard 1400 mm and the side screens have two different depths either 850 mm or 1200 mm. Select screens in the same textile or in a color scale to create unique workplaces. Keep clean and tidy around and under the desk by choosing a recessed cable grommet in the screens.

SCREENIT A30 BOOTH

ScreenIT A30 floor screen booth

See price ranges in textile chapter.

Booth with black feet	Pricer. 1	Pricer. 2	Pricer. 3	Pricer. 4
852120- W. 1200 H. 1400	1229,57	1323,30	2040,00	2624,57
852140-*W. 1400 H. 1400	1279,89	1373,83	2343,19	2767,55
852160-*W. 1600 H. 1400	1320,11	1428,72	2386,81	2897,02
852180-*W. 1800 H. 1400	1382,66	1451,60	2452,23	3022,02

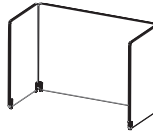

Order procedure floor screen, see page 51.

For floor screen accessories, please see Toolbar chapter.



ADJUSTABLE FEET

Floor screen booths include adjustable feet. Adjustable up to 50 mm.

A30 PEAK DESIGN BOOTH

A30 Peak Design Booth

See price ranges in textile chapter.

Front screen without grommet	Pricer. 1	Pricer. 2	Pricer. 3	Pricer. 4
119120-*W. 1200 H. 1400	555,64	577,98	718,40	941,17
119140-*W. 1400 H. 1400	580,74	616,06	970,11	1246,60
119160-*W. 1600 H. 1400	630,43	649,89	1087,87	1401,81
119180-*W. 1800 H. 1400	699,89	742,98	1197,23	1547,77

Front screen with grommet Ø 60

119121-*W. 1200 H. 1400	665,53	688,40	820,74	1047,98
119141-*W. 1400 H. 1400	686,91	724,89	1069,47	1350,32
119161-*W. 1600 H. 1400	736,91	760,96	1187,13	1505,00
119181-*W. 1800 H. 1400	806,49	851,81	1296,91	1651,28

Side screen big without grommet

119124- W. 1200 H. 1400	635,11	696,17	850,85	1044,57
-------------------------	--------	--------	--------	---------

Side screen big with grommet Ø 60

119125- W. 1200 H. 1400	726,17	789,68	935,96	1132,87
-------------------------	--------	--------	--------	---------

Side screen small without grommet

119854- W. 850 H. 1400	515,96	534,26	764,79	954,89
------------------------	--------	--------	--------	--------

Side screen small with grommet Ø 60

119855- W. 850 H. 1400	607,13	627,98	849,79	1043,51
------------------------	--------	--------	--------	---------

Important information: Inner dimensions. Mounted feet included.
Can only be ordered with seam. Zipper is only used to connect screens.
Not available with fishbone zip. Grommet in black.
Silver and white as special.

For floor screen accessories, please see Toolbar chapter.

*Screens over 1200 mm ordered with textiles: Ally, Blazer, Bond, Era, Houston Reflect, Illusion, Kaiman, Lido, Noble lux, Remix 3, Rivet and Synergy will be with a decor seam.





ROOM WITHIN A ROOM

Creating natural meeting places in large open spaces that today's offices often are made of, is one of the strengths with the room-within-a-room concept. Our popular The Hut Collection contributes with a dynamic feeling and an eye-catching detail, all while the screened off spaces generate creative condition and improve acoustics for everyone. Create fun combinations with the components from The Hut Lounge Collection, made up of relaxed and stylish pieces.



THE HUT GEM WITH DESK

The sound-absorbing house The Hut with an integrated desk makes it even easier to quickly offer a workplace or a meeting room with space for your computer or notebook. Electrical outlets or other electrical products can advantageously be mounted in the desk. Surface material on desk is laminate. The house's simple and straight lines are inspired by the classic Monopoly game and it's pieces, which gives a timeless shape for the popular and practical "room within a room" concept.



THE HUT GEM

Height of the desk 940 mm from floor, depth 800 mm. Fits bar stool with seat height 650 mm. Cable channel for lamp included, lamp is purchased separately. Thickness 40 mm.

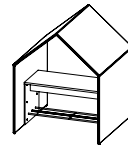

The Hut GEM with desk

Including black footrest.
111010-

See price ranges in textile chapter.

Pricer. 1	Pricer. 2	Pricer. 3	Pricer. 4
5096,17	5623,94	6855,53	9963,62

External dimensions: W.1880 H.2270 D.1800.

Internal dimensions: W.1800 H.2220 D.1800.

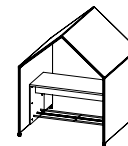

The Hut GEM with desk and wheels

Including black footrest and black lockable wheels.
111020-

5272,13	5858,51	7031,38	10139,57
---------	---------	---------	----------

External dimensions: W.1880 H.2270 D.1800.

Internal dimensions: W.1800 H.2220 D.1800.

Laminate

910 ash
911 oak
912 walnut
913 white
914 black



ash



oak



walnut



white



black

ORDER THE HUT GEM:

1. Choose The Hut GEM or Half a Hut GEM.
2. Choose textile and colour.
3. Choose laminate.

Exemple: The Hut GEM with desk-event screen 60021-ash laminate, 111010-06-910.



HALF A HUT GEM WITH DESK



SCRIBBLE WRITING BOARD THE HUT GEM

Attach the stylish and practical writing board on your The Hut GEM and use for all kind of meetings and information. The board's front is made of hardened tempered glass with a plate of sheet metal on the back, making it possible to both write on the glass and attach papers with magnets. Concealed suspension.



MAGAZINE +

Magazine+ is a magazine shelf for The Hut GEM and Half a Hut GEM with room for magazines. Perfect for easily accessible reading during your lunch or coffee break.

HALF A HUT GEM

Height of the desk 940 mm from floor, depth 800 mm. Fits bar stool with seat height 650 mm. Cable channel for lamp included, lamp is purchased separately. Thickness 40 mm.

Half a Hut GEM with desk

Including black footrest.
111030-

See price ranges in textile chapter.

Pricer. 1	Pricer. 2	Pricer. 3	Pricer. 4
4040,64	4333,83	5506,70	7324,68

External dimensions: W.1880 H.2270 D.900.

Internal dimensions: W.1800 H.2220 D.900.

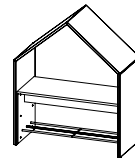

Half a Hut GEM with desk and wheels

Including black footrest and black lockable wheels.
111040-

4216,49	4509,79	5682,66	7500,53
---------	---------	---------	---------

External dimensions: W.1880 H.2270 D.900.

Internal dimensions: W.1800 H.2220 D.900.

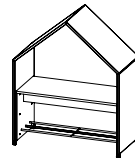

ACCESSORIES

Scrabble writing board

Magnetic writing board with tempered safety glass and sheet metal back.

101013	W. 800	H. 350	D. 4	white	290.43
101013-1	W. 800	H. 350	D. 4	sand	356.17
101013-2	W. 800	H. 350	D. 4	mist	356.17

Magazine +

Magazine shelf for The Hut GEM/Half a Hut GEM. Screw included.
Material: lacquered metal.

637208-1	W. 800	H. 220	D. 45	white	98.09
637208-2	W. 800	H. 220	D. 45	black	98.09

Mounting: make a hole in the fabric where the insert nut are placed to be able to mount the rail on which the writing board/Magazine + is hung. Rail and screw included.



The sound absorbing house can be used as an individual work station, a small sit or stand meeting room or a relax zone with The Hut Sofa. The house's simple and straight lines are inspired by the classic Monopoly game and it's pieces, which gives a timeless shape for the popular and practical "room within a room" concept.



Complement with front screens at The Hut, which gives a more enveloping impression.



The Hut Lamp provides nice lighting in The Hut and fits just as well with The Hut as with Half a Hut.

THE HUT

See price ranges in textile chapter.

The Hut with cable channel 110280-	Pricer. 1 4232,77	Pricer. 2 4565,64	Pricer. 3 6306,91	Pricer. 4 9410,96
----------------------------------------------	-----------------------------	-----------------------------	-----------------------------	-----------------------------

Out. meas: W. 1880 H. 2270 D. 1800 In. meas: W. 1790 H. 2220 D. 1760

Info: Prices above are with the same textile on both sides.
If you want different combinations of textiles, please contact us for a price.

THE HUT WITH FRONT SCREENS

The Hut with cable channel 110800-	6175,00	6860,21	8377,66	10528,09
----------------------------------------------	---------	---------	---------	----------

Out. meas: W. 1880 H. 2270 D. 1860 In. meas: W. 1790 H. 2220 D. 1760

Info: Prices above are with the same textile on both sides.
If you want different combinations of textiles, please contact us for a price.

ORDER PROCEDURE FOR THE HUT

1. Select type of The Hut.
2. Select textile (see colour map on page 6-16).

EXAMPLE

The Hut with cable channel - 148 Orchid from Lido 110280 - 202

THE HUT LAMP



The Hut Lamp

5 m black textile-covered cord with switch and E27 socket. 3-step click attenuation, the light effect is easily changed by clicking on the switch

821020

142.77



A sound-absorbing smaller room that fits well in larger rooms where there is a need for shielding office space.

HALF A HUT

See price ranges in textile chapter.

Half a Hut with cable channel 110420-	Pricer. 1	Pricer. 2	Pricer. 3	Pricer. 4
	3433,72	3549,15	5132,55	7003,83

Out. meas: W. 1880 H. 2270 D. 900 In. meas: W. 1790 H. 2220 D. 860

Info: Prices above are with the same textile on both sides.
If you want different combinations of textiles, please contact us for a price.



A sound-absorbing smaller room with front screens for a more enveloping impression.

HALF A HUT WITH FRONT SCREEN

Half a Hut with cable channel 110880-	4128,62	4312,87	5756,06	7623,51

Out. meas: W. 1880 H. 2270 D. 960 In. meas: W. 1790 H. 2220 D. 860

Info: Prices above are with the same textile on both sides.
If you want different combinations of textiles, please contact us for a price.

ORDER PROCEDURE FOR HALF A HUT

1. Select type of Half a Hut.
 2. Select textile (see colour map on page 6-16).
- Example: Half a Hut with cable channel - 148
Orchid from Lido 110420 - 202



CUSHION

Cushion square

Unlaminated. Zip hidden. Inner cushion made of synthetic fiber.

657111- W. 440 H. 180 D. 440

54,36

Cushion rectangle

Unlaminated. Zip hidden. Inner cushion made of synthetic fiber.

657101- W. 760 H. 180 D. 380

68,19

LIDO BY
NEVOTEX

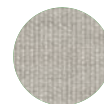

Colour 200
(132 Toned)

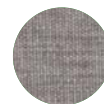

Colour 201
(17 Concrete)



Colour 202
(148 Orchid)



Colour 203
(71 Plum)

FIESTA BY
NEVOTEX



Colour 70
(113 loe)



Colour 71
(17 Concrete)

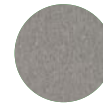

Colour 72
(120 Silver melange)



Colour 73
(32 Antracite)



The Open Huts are two more siblings in our popular Hut family. With front screens on both sides, they work as airy room within the rooms in both the office landscape as well as the hotel entrance. Add one or two The Hut/Half a Hut Sofas inside for a nice meeting place or a screened off work space.

OPEN HUT

Open Hut with cable channel *See price ranges in textile chapter.*
Pricer. 1 Pricer. 2 Pricer. 3 Pricer. 4
 110200- | 6588,72 | 7283,72 | 9104,26 | 10913,30 |

Out. meas: W. 1880 H. 2270 D. 1880 In. meas: W. 1790 H. 2220 D. 1760



Bright

Dimmable LED lamp and brass base. 5 m black decorative textile cable. Has unearthed plug. (Dimmer not included.) See more information in the Lighting Chapter.

821025

187.77



Pocket Table

The table is available in three combinations: oak veneer with a white stand, oak veneer with a black stand and black lacquered oak veneer with a black stand. Pocket in artificial leather.

891041 W. 580 H. 665 D. 380 oak/white 533.09

891042 W. 580 H. 665 D. 380 oak/black 533.09

891043 W. 580 H. 665 D. 380 black/black 533.09



No Pocket Table

The table is available in three combinations: oak veneer with a white stand, oak veneer with a black stand and black lacquered oak veneer with a black stand.

W. 580 H. 665 D. 380

891044 oak/white 410.00

891045 oak/black 410.00

891046 black lacquered/black 410.00



Open Half a Hut is another variant in our popular Hut family. Works as an airy room in the room and has room for 2 The Hut Sofa. Excellent for relaxed meetings or a screened off work.

OPEN HALF A HUT

Open Half a Hut with cable channel *See price ranges in textile chapter.*
Pricer. 1 Pricer. 2 Pricer. 3 Pricer. 4
 110210- | 4830,74 | 5359,68 | 6847,98 | 8327,13 |

Out. meas: W. 1880 H. 2270 D. 980

In. meas: W. 1790 H. 2220 D. 860



The Hut Lamp

5 m black textile-covered cord with switch and E27 socket. 3-step click attenuation, the light effect is easily changed by clicking on the switch.

821020

142.77

ORDER OPEN HUT/OPEN HALF A HUT

1 Choose Open Hut or Open Half a Hut

2. Choose textile and colour, see page 6-16.

Example: Open Hut - Kinship from Synergy 110200 - 622

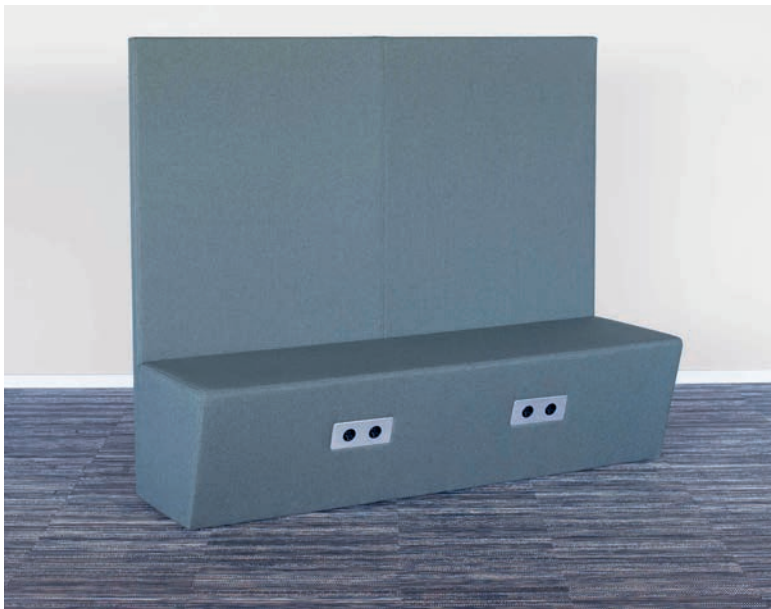

THE HUT SOFA

See price ranges in textile chapter.

	Pricer. 1	Pricer. 2	Pricer. 3	Pricer. 4
The Hut Sofa 647110- W. 1760 H. 1450 D. 550	2520,00	2660,11	3224,68	4218,09
The Hut Sofa, Table Top white 647111- W. 1760 H. 1450 D. 550	2673,30	2841,49	3378,19	4357,23
The Hut Sofa, Table Top black 647113- W. 1760 H. 1450 D. 550	2673,30	2841,49	3378,19	4357,23
The Hut Sofa, Table Top silver 647118- W. 1760 H. 1450 D. 550	2673,30	2841,49	3378,19	4357,23



HALF A HUT SOFA

See price ranges in textile chapter.

	Pricer. 1	Pricer. 2	Pricer. 3	Pricer. 4
Half a Hut Sofa 647130- W. 860 H. 1450 D. 550	1723,83	1839,89	2166,06	2479,57
Half a Hut Sofa, Table Top white 647131- W. 860 H. 1450 D. 550	1824,89	1954,47	2272,87	2577,77
Half a Hut Sofa, Table Top black 647133- W. 860 H. 1450 D. 550	1824,89	1954,47	2272,87	2577,77
Half a Hut Sofa, Table Top silver 647138- W. 860 H. 1450 D. 550	1824,89	1954,47	2272,87	2577,77

Note: External dimensions. Seat height: 450 mm. Seat depth: 500 mm.
Half a Hut Sofa with Table Top includes 1 x 2 sockets.
Table Top is a power outlet mounted in the sofa.

Prices apply to colours on page 6-16. Textiles that can be selected:
Pricer. 1: Omega, Pearl, Event Screen +, Mica, Slope, Tonal
Pricer. 2: Houston Reflect, Lido, Rivet, Kaiman, Noble lux, Era
Pricer. 3: Blazer, Bond, Synergy, Ally
Pricer. 4: Step, Remix 3

Specify the article number as follow:
Sofa - textile colour (seam as textile)The Hut - textile colour (seam as textile)



BACKREST

See price ranges in textile chapter.

	Pricer. 1	Pricer. 2	Pricer. 3	Pricer. 4
Backrest Sofa Sound Booth 657300- W. 1600 H. 350 D. 130	412,45	453,62	550,11	674,04
Backrest Time Out 657310- W. 1700 H. 350 D. 130	412,45	453,62	550,11	674,04
Backrest The Hut Sofa 657320- W. 1740 H. 350 D. 130	412,45	453,62	550,11	674,04
Backrest Half a Hut Sofa 657330- W. 840 H. 350 D. 130	260,96	274,79	329,89	384,79

HOW TO ORDER BACKREST THE HUT SOFA/HALF A HUT SOFA/TIME OUT
Specify the article number as follow:
Backrest - textile colour (seam as textile colour).

HOW TO ORDER BACKREST SOFA SOUND BOOTH
Specify the article number as follow: Backrest - textile colour - seam colour.

Prices apply to colours on page 6-16. Textiles that can be selected:
Pricer. 1: Omega, Pearl, Event Screen +, Mica, Slope, Tonal
Pricer. 2: Houston Reflect, Lido, Rivet, Kaiman, Noble lux, Era
Pricer. 3: Blazer, Bond, Synergy, Ally
Pricer. 4: Remix 3, Illusion



SOFA SILENT GROUP

See price ranges in textile chapter.

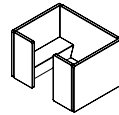

Sofa Silent Group	Pricer. 1	Pricer. 2	Pricer. 3	Pricer. 4
647300-	7947,98	8152,13	10223,72	11814,47
W. 2200 H. 1400 D. 1700				

Sofa Silent Group, Table Top white	Pricer. 1	Pricer. 2	Pricer. 3	Pricer. 4
647311-	8567,87	8772,02	10843,72	12434,26
W. 2200 H. 1400 D. 1700				

Sofa Silent Group, Table Top silver	Pricer. 1	Pricer. 2	Pricer. 3	Pricer. 4
647313-	8567,87	8772,02	10843,72	12434,26
W. 2200 H. 1400 D. 1700				

Sofa Silent Group, Table Top black	Pricer. 1	Pricer. 2	Pricer. 3	Pricer. 4
647318-	8567,87	8772,02	10843,72	12434,26
W. 2200 H. 1400 D. 1700				

Note: External dimensions. Seat height: 450 mm. Seat depth: 500mm. Sofa Silent Group with Table Top includes 4 x 2 sockets.

Prices apply to colours on page 6-16. Textiles that can be selected:

- Pricer. 1: Omega, Pearl, Event Screen +, Mica, Slope, Tonal
- Pricer. 2: Houston Reflect, Lido, Rivet, Kaiman, Noble lux, Era
- Pricer. 3: Blazer, Bond, Synergy, Ally
- Pricer. 4: Remix 3, Illusion

Specify the article number as follow:

Sofa - textile colour - zip colour (seam as zip edgings)

Sofa Silent Group forms a room within an open landscape, in the hotel lobby as well as in public areas. The group consists of 80 mm thick screen walls which makes it to a very quiet place for meetings and relaxation. Ideal to combine with The Hut Roof.



THE HUT ROOF

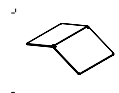

The Hut Roof		Pricer. 1	Pricer. 2	Pricer. 3	Pricer. 4
With seam					
130140-	D. 1400 W. 1300	1226,38	1376,91	1831,06	2254,36
130160-	D. 1600 W. 1300	1398,83	1491,06	2047,98	2528,62
130180-	D. 1800 W. 1300	1516,49	1722,55	2245,32	2783,19
130200-	D. 2000 W. 1300	1683,40	1912,23	2491,28	3086,91
With zip					
130140-	D. 1400 W. 1300	1295,53	1425,00	1942,34	2379,36
130160-	D. 1600 W. 1300	1432,23	1545,85	2174,57	2670,53
130180-	D. 1800 W. 1300	1582,13	1786,06	2386,17	2942,13
130200-	D. 2000 W. 1300	1757,45	1983,51	2648,94	3263,62

ORDER PROCEDURE THE HUT ROOF

1. Select screen size.
2. Select screen colour (see colour map at page 6-16).
3. Select zip or seam colour (see colours on page 17.)

Facts: Mounting kit with wire (2 meter) and screws included. (Not screws for the ceiling.) The customer is responsible for the ceiling suitable for suspension.

Mount for ceiling rail

6 pcs in needed for The Hut Roof. When mounting in ceiling rail. See drawings at www.gotessons.com

642041-1 white -2 black

13.09

The Hut Roof includes two ScreenIT A30 which are connected with a leather strap. Suspending in the air and attached via the ceiling. The sound absorbing roof creates a room within the room.



THE HUT LOUNGE

The Hut Lounge

The Hut Lounge always has a cable channel.

Must always be connected with 2 The Hut Bench.

See price ranges in textile chapter.

	Pricer. 1	Pricer. 2	Pricer. 3	Pricer. 4
110902-	4232,77	4565,64	6306,91	9410,96

Out. meas: W. 1880 H. 2270 D. 1800 In. meas: W. 1800 H. 2220 D. 1800.
The specified height includes a mounted Bench.



HALF A HUT LOUNGE

Half a Hut Lounge

Must always be connected
with 1 The Hut Bench.

See price ranges in textile chapter.

	Pricer. 1	Pricer. 2	Pricer. 3	Pricer. 4
110905-	3433,72	3549,15	5132,55	7003,83

Out. meas: W. 1880 H. 2270 D. 900 In. meas: W. 1800 H. 2220 D. 900.
The specified height includes a mounted Bench.

ORDER PROCEDURE:

1. Select The Hut Lounge or Half A Hut Lounge
2. Choose textile, see page 6-16.
3. Choose 2 Benches with or without Table Top for The Hut Lounge or 1 Bench for Half A Hut Lounge with or without Table Top.
4. Choose textile, see page 6-16.
5. Choose Bench Cover that fits the amount and size of your bench(es).
6. Choose textile. See below which textiles that are available for Bench Covers:

Order example:

The Hut Lounge - Textile (seam as textile) 110902 - 02
2 x The Hut Bench with black Table Top - Textile (seam as textile)
2 x 110913 - 02 Double Bench Cover - Textile (seam as textile)
110940 - 02 Half a Hut Lounge - 108 Event Screen +

Prices apply to colours on page 6-16. Textiles that can be selected:

- Pricer. 1: Omega, Pearl, Event Screen +, Mica, Slope, Tonal
Pricer. 2: Houston Reflect, Lido, Rivet, Kaiman, Noble lux, Era
Pricer. 3: Blazer, Bond, Synergy, Ally
Pricer. 4: Step, Remix 3



THE HUT BENCH

THE HUT BENCH

The Hut Bench is always fitted with wheels. The Hut Bench must always be connected to a The Hut Lounge/Half a Hut Lounge. See price ranges in textile chapter.

	Pricer. 1	Pricer. 2	Pricer. 3	Pricer. 4
 The Hut Bench 110910- W. 1800H. 450 D. 900	1779,79	1883,19	2216,81	2652,02
 The Hut Bench, Table Top white 110911- W. 1800H. 450 D. 900	1963,40	2066,91	2400,53	2835,64
 The Hut Bench, Table Top black 110913- W. 1800H. 450 D. 900	1963,40	2066,91	2400,53	2835,64
 The Hut Bench, Table Top silver 110918- W. 1800H. 450 D. 900	1963,40	2066,91	2400,53	2835,64

Note: The Hut Bench with Table Top includes 2 x 2 sockets. Table Top is a power outlet mounted in the bench. Max load 400 kg per Bench. Bench height includes mattress and wheels.





Bench – the key object in three formats as a part of The Hut Lounge collection. Place a Free Bench in the entrance fitted with Table Top to meet every visitor's wish. Combine the Square Bench with any constellation to create dynamic and add an extra nice design detail.



FREE BENCH AND SQUARE BENCH

FREE BENCH

Square Bench is always fitted with wheels. Can be used as free standing or connected to other Benches.

 Free Bench 110920- W. 1800 H. 450 D. 900	1779,79	1883,19	2216,81	2652,02
 Free Bench, Table Top white 110921- W. 1800 H. 450 D. 900	1963,40	2066,91	2400,53	2835,64
 Free Bench, Table Top black 110923- W. 1800 H. 450 D. 900	1963,40	2066,91	2400,53	2835,64
 Free Bench, Table Top silver 110928- W. 1800 H. 450 D. 900	1963,40	2066,91	2400,53	2835,64



Note: The Hut Bench with Table Top includes 2 x 2 sockets. Table Top is a power outlet mounted in the bench. Max load 400 kg per Bench. Bench height includes mattress and wheels.

SQUARE BENCH

Square Bench is always fitted with wheels. Can be used as free standing or connected to other Benches.

110930- W. 900H. 450 D. 900	1279,79	1325,96	1562,34	1836,91
-----------------------------	---------	---------	---------	---------

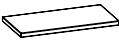
BENCH COVERS

 Bench Cover 110950- W. 1800 H. 80 D. 900	605,74	739,57	887,13	1030,21
 Double Bench Cover <i>Always has decor seam in the middle.</i> 110940- W. 1800 H. 80 D. 1800	903,72	1261,49	1375,85	1781,91
 Square Bench Cover 110960- W. 900 H. 80 D. 900	403,51	486,91	560,96	647,45

Prices apply to colours on page 6-16. Textiles that can be selected:

Pricer. 1: Omega, Pearl, Event Screen +, Mica, Slope, Tonal
Pricer. 2: Houston Reflect, Lido, Rivet, Kaiman, Noble lux, Era
Pricer. 3: Blazer, Bond, Synergy, Ally
Pricer. 4: Remix 3, Illusion





TIME OUT

See price ranges in textile chapter.

Time Out	Pricer. 1	Pricer. 2	Pricer. 3	Pricer. 4
647150-	3393,72	3531,38	4405,74	5590,11
Time Out, 2 Table Top white 647151-	3627,87	3765,53	4639,89	5824,15
Time Out, 2 Table Top black 647153-	3627,87	3765,53	4639,89	5824,15
Time Out, 2 Table Top silver 647158-	3627,87	3765,53	4639,89	5824,15

Out. mesure. W. 1800 D. 900 H. 2222.

Note: External dimensions. Seat height: 450 mm. Seat depth: 500 mm. Time Out with Table Top includes 2 mounted sockets. Table Top is a power outlet mounted in the sofa.

HOW TO ORDER TIME OUT:

Article number: Time Out - textile - zip (seam like zip's edge).

Example: 647153-253-113 Time Out incl 2 pc Table Top black in Slope 33 Crystal with silver grey/brown fishbone zip (seam will be grey/brown).

Time Out is a modern sound absorbing sofa with a roof built with A30 screens. Choose with or without electric sockets to create relaxed work spaces or a comfortable place to charge your phone in the lobby. The sofa works excellent as a solitaire piece or in a group. Two Time Out placed opposite each other creates a nice and airy room in the room. Great to combine with Backrest and Pocket Table for a complete solution.





WHITEBOARDS, NOTICE BOARDS, WRITING BOARDS

Stylish and practical writing and notice boards are a must for all creative meetings.

We have a variety of solutions to offer; independent on wheels, hung on screens or maybe placed in The Hut. Our mounted writing boards are great sound absorbers and offer the perfect place for pins, magnets or metal lists.



Scribble is our new whiteboard with hidden mounting fittings that makes the board more clean and stylish. Mount directly on the wall or choose the models attached to A40 screens. On wall or with feet to stand on floor.



SCRIBBLE WRITING BOARD

Scribble writing board

Magnetic writing board made of tempered glass. Sheet metal back. Concealed wall suspension for blackboard included.

101014	W. 990	H. 990	D. 4	white	608.19
101014-1	W. 990	H. 990	D. 4	sand	717.77
101014-2	W. 990	H. 990	D. 4	mist	717.77
101025	W. 990	H. 1590	D. 4	white	980.74
101025-1	W. 990	H. 1590	D. 4	sand	1090.32
101025-2	W. 990	H. 1590	D. 4	mist	1090.32
101024	W. 1590	H. 990	D. 4	white	980.74
101024-1	W. 1590	H. 990	D. 4	sand	1090.32
101024-2	W. 1590	H. 990	D. 4	mist	1090.32

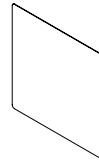

Scribble writing board

Magnetic writing board made of tempered glass. Sheet metal back. Concealed wall suspension for blackboard included.

101015	W. 250	H. 250	D. 4	white	213.72
101015-1	W. 250	H. 250	D. 4	sand	213.72
101015-2	W. 250	H. 250	D. 4	mist	213.72

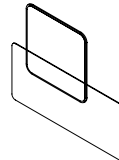

Scribble writing board

Magnetic writing board with tempered safety glass and sheet metal back.

101013	W. 800	H. 350	D. 4	white	290.43
101013-1	W. 800	H. 350	D. 4	sand	356.17
101013-2	W. 800	H. 350	D. 4	mist	356.17

Mounting: make a hole in the fabric where the insert nut sits to be able to screw on a suspension strip on which the writing board/Magazine + is hung. Strip and screw included.



Writing board white.



Writing board sand.



Writing board mist.



A40 SCRIBBLE´N PIN

A40 Scribble´n pin

The screen is made up of a wooden frame, 40 mm sound absorber and 5 mm foam laminated textile. Total thickness 50 mm.

Writing board and wall bracket are ordered separately.

530191 - fits glass writing board 990x990

536191 - fits glass writing board 1590x990

536192 - fits glass writing board 990x1590

See price ranges in textile chapter.

With seam	Pricer. 1	Pricer. 2	Pricer. 3	Pricer. 4
530191 - W. 1400 H. 1000	509,04	563,72	717,02	935,96
536191 - W. 2000 H. 1000	727,98	793,62	979,79	1253,40
536192 - W. 1400 H. 1600	738,94	837,45	1045,43	1373,83
With zip				
530191 - W. 1400 H. 1000	552,77	607,55	760,85	1012,55
536191 - W. 2000 H. 1000	771,70	837,45	1034,47	1297,23
536192 - W. 1400 H. 1600	782,66	881,17	1089,26	1428,51

Scribble wall mount kit

Mounted together with Scribble´n Pin wall. Two people are required.

649003	W. 950	H. 960	D. 30	white	96.28
649004	W. 1550	H. 960	D. 30	white	101.81

SCRIBBLE FLOORSCREEN

Scribble writing board floor screen

The screen is made of wooden frame, 40 mm sound absorber and 5 mm foam laminated textile. Total thickness 50 mm. Writing board and foot package ordered separately.

530181 - fits writing board 990x990

536182 - fits writing board 990x1590

536181 - fits writing board 1590x990

See price ranges in textile chapter.

With seam	Pricer. 1	Pricer. 2	Pricer. 3	Pricer. 4
530181 - W. 1000 H. 1800	574,68	651,38	881,17	1100,11
536182 - W. 1000 H. 1800	695,11	727,98	892,13	1143,94
536181 - W. 1600 H. 1800	706,06	815,53	1143,94	1461,38
With zip				
530181 - W. 1000 H. 1800	629,47	695,11	925,00	1122,02
536182 - W. 1000 H. 1800	727,98	793,62	946,91	1198,72
536181 - W. 1600 H. 1800	749,89	859,36	1198,72	1494,26

Foot set with wheels for floor screen

Lockable wheels. 4 in one pack.

643060-1	white -2 black -3 silver	233.51
----------	--------------------------	--------

Foot set Woodland for Floorscreen A40/Sketch/Scribble

Foot in molded wood with ash veneer and metal fittings. 4 feet included.

643066-1	white*/ash	257.98
643066-2	black*/ash	257.98
643066-3	silver*/ash	257.98

Foot Set Slide-in Woodland with wheels for A40/Sketch/Scribble Floor screen

Foot set in molded wood with ash veneer and metal fittings. 4 feet with wheels included. The wheels are lockable.

643065-1	white*/ash	335.43
643065-2	black*/ash	335.43
643065-3	silver*/ash	335.43

* Colour indicates wheels and fittings.

Scribble pen shelf Woodland

Material: solid ash.

637165 - fits writing board 990 mm.

637166 - fits writing board 1590 mm.

637165	W. 930	H. 70	D. 82	ash/white	160.00
637166	W. 765	H. 70	D. 82	ash/white	160.00

Scribble pen shelf

Material: metal.

637167 - fits writing board 990 mm.

637168 - fits writing board 1590 mm.

637167-1	W. 930	H. 70	D. 61	white	41.49
637167-2	W. 930	H. 70	D. 61	black	41.49
637168-1	W. 765	H. 70	D. 61	white	41.49
637168-2	W. 765	H. 70	D. 61	black	41.49

Stylish and practical writing board with hidden attachment to screen. The glass surface is made of tempered safety glass with a magnetic surface, which makes it easy to both attach paper and write directly on the board. The board on floor screen has four rotatable and lockable wheels that allow you to quickly switch from a writing board to a sound-absorbing notice board where you can conveniently attach pictures and documents with pins..

Order procedure for Scribble´n Pin:

1. Chose screen. Specify the article number for the screen as follow: Screen - fabric colour - zip/seam colour.

Example: 536191-01-101.

2. Order writing board.

Order procedure for Scribble writing board floorscreen on wheels:

1. Chose screen Specify the article number for the screen as follow:

Screen - fabric colour - zip/seam colour.

Example: 536181-01-101.

2. Order writing board.

3. Order foot set.



The Sketch Pin A40 is a stylish and practical writing board with a glass slide mounted on a ScreenIT A40. Mounted on the wall. Attach paper with magnets or write directly on the board. Pin with needles on the wall screen next to the writing board.



SKETCH'N PIN A40

Sketch'n Pin A40

The wall screen is made of a wooden frame, 40 mm sound absorber and 5 mm foam-laminated textile on each side. Total thickness 50 mm. Wall bracket included. Writing board purchased separately

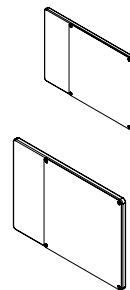

See price ranges in textile chapter.

	Pricer. 1	Pricer. 2	Pricer. 3	Pricer. 4
With seam				
530190- W. 1400 H. 1000	485,96	543,62	761,17	946,91
536190- W. 2000 H. 1000	703,83	767,77	1023,83	1228,72
With zip				
530190- W. 1400 H. 1000	530,74	588,40	806,17	991,81
536190- W. 2000 H. 1000	748,51	812,45	1068,62	1273,51

Order procedure for Sketch'n Pin:

1. Chose screen Specify the article number for the screen as follow:
Screen - fabric colour - zip/seam colour.
Example: 536190-01-101.
2. Order writing board.

SKETCH'N PIN WRITING BOARD

Sketch'n Pin writing board

Writing board in glass to mount on Sketch'n Pin A40 1400x1000 mm.
Front: tempered safety glass. Back: sheet metal.

101012	W. 990	H. 990	D. 4	white	750.64
101012-1	W. 990	H. 990	D. 4	sand	851.38
101012-2	W. 990	H. 990	D. 4	mist	851.38
101012-3	W. 990	H. 990	D. 4	olive	851.38
101012-4	W. 990	H. 990	D. 4	ocean	851.38
101012-5	W. 990	H. 990	D. 4	rhubarb	851.38
101012-6	W. 990	H. 990	D. 4	lilac	851.38
101012-7	W. 990	H. 990	D. 4	harvest	851.38

Sketch'n Pin writing board

101022	W. 1590	H. 990	D. 4	white	1111.91
101022-1	W. 1590	H. 990	D. 4	sand	1212.98
101022-2	W. 1590	H. 990	D. 4	mist	1212.98
101022-3	W. 1590	H. 990	D. 4	olive	1212.98
101022-4	W. 1590	H. 990	D. 4	ocean	1212.98
101022-5	W. 1590	H. 990	D. 4	rhubarb	1212.98
101022-6	W. 1590	H. 990	D. 4	lilac	1212.98
101022-7	W. 1590	H. 990	D. 4	harvest	1212.98



Writing board white.



Writing board sand.



Writing board harvest.



Writing board olive.



Writing board rhubarb.

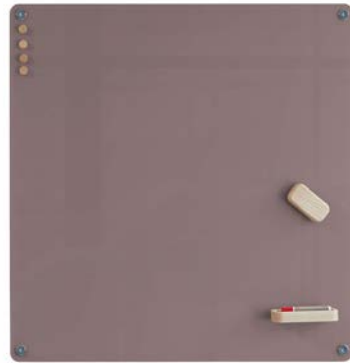

Writing board lilac.



Writing board mist.



Writing board ocean.



Attach the stylish and practical writing board to the wall and use for all kind of meetings and information. The board's front is made of hardened tempered glass with a plate of sheet metal on the back, making it possible to both write on the glass and attach papers with magnets. The board appears 30 mm from the wall when mounted.



SKETCH WRITING BOARD WALL

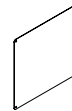

Sketch writing board wall

Writing board in glass to mount on wall. Screws included. Glass 4 mm.

101011	W. 990	H. 990	D. 4	white	750.64
101011-1	W. 990	H. 990	D. 4	sand	851.38
101011-2	W. 990	H. 990	D. 4	mist	851.38
101011-3	W. 990	H. 990	D. 4	olive	851.38
101011-4	W. 990	H. 990	D. 4	ocean	851.38
101011-5	W. 990	H. 990	D. 4	rhubarb	851.38
101011-6	W. 990	H. 990	D. 4	lilac	851.38
101011-7	W. 990	H. 990	D. 4	harvest	851.38

Sketch writing board wall

Writing board in glass to mount on wall. Screws included. Glass 4 mm.

101021	W. 1590	H. 990	D. 4	white	1111.91
101021-1	W. 1590	H. 990	D. 4	sand	1212.98
101021-2	W. 1590	H. 990	D. 4	mist	1212.98
101021-3	W. 1590	H. 990	D. 4	olive	1212.98
101021-4	W. 1590	H. 990	D. 4	ocean	1212.98
101021-5	W. 1590	H. 990	D. 4	rhubarb	1212.98
101021-6	W. 1590	H. 990	D. 4	lilac	1212.98
101021-7	W. 1590	H. 990	D. 4	harvest	1212.98



Stylish and practical writing board on wheels. The glass surface is made of hardened tempered glass with magnetic surface, making it easy to attach both paper and write directly on the board. The board has four lockable wheels that allow you to switch quickly from whiteboard page to a sound-absorbing bulletin board, which conveniently attaches images and documents with needles.



SKETCH WRITING BOARD FLOOR SCREEN

Sketch writing board floor screen

Thickness A40= 50 mm.

See price ranges in textile chapter.

With seam

			Pricer. 1	Pricer. 2	Pricer. 3	Pricer. 4
530180-	W. 1000 H. 1800		545,32	627,23	886,49	1077,66
536180-	W. 1600 H. 1800		681,81	791,06	1159,47	1432,45

With zip

530180-	W. 1000 H. 1800		589,68	671,60	931,06	1122,02
536180-	W. 1600 H. 1800		726,28	835,53	1204,04	1477,02

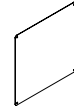

Sketch writing board floor screen

Writing board in glass to mount on floor screen. Screws included.

Glass 4 mm. Designed for screen 1000 mm.

101010	W. 990 H. 990 D. 4	white	694,68
101010-1	W. 990 H. 990 D. 4	sand	795,74
101010-2	W. 990 H. 990 D. 4	mist	795,74
101010-3	W. 990 H. 990 D. 4	olive	795,74
101010-4	W. 990 H. 990 D. 4	ocean	795,74
101010-5	W. 990 H. 990 D. 4	rhubarb	795,74
101010-6	W. 990 H. 990 D. 4	lilac	795,74
101010-7	W. 990 H. 990 D. 4	harvest	795,74

Sketch writing board floor screen

Writing board in glass to mount on floor screen and Moving Wall

Media. Screws included. Glass 4 mm. Designed for screen 1600 mm.

101016	W. 1590 H. 990 D. 4	white	1038,94
101016-1	W. 1590 H. 990 D. 4	sand	1139,47
101016-2	W. 1590 H. 990 D. 4	mist	1139,47
101016-3	W. 1590 H. 990 D. 4	olive	1139,47
101016-4	W. 1590 H. 990 D. 4	ocean	1139,47
101016-5	W. 1590 H. 990 D. 4	rhubarb	1139,47
101016-6	W. 1590 H. 990 D. 4	lilac	1139,47
101016-7	W. 1590 H. 990 D. 4	harvest	1139,47



Foot set with wheels for floor screen

Lockable wheels. 4 in one pack.

643060-1	white -2 black -3 silver	233,51
----------	--------------------------	--------

Woodland foot package, see next page.

Order procedure for Sketch writing board on wheels:

1. Chose screen Specify the article number for the screen as follow:

Screen - fabric colour - zip/seam colour.

Example: 536180-01-101.2. Order writing board.

3. Order foot set.

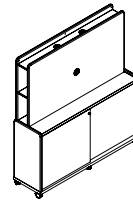

Moving Wall Media

Reinforced screen for mounting of TV screen. Wooden details in laminate.

Max width TV: 65". Max weight TV: 35 kg.

W. 1650 H. 1800 D. 450

110030-	ash	5693,72	6346,81	7229,36	7605,64
110031-	oak	5693,72	6346,81	7229,36	7605,64
110032-	walnut	5693,72	6346,81	7229,36	7605,64
110033-	white	5693,72	6346,81	7229,36	7605,64

Sketch Writing Board Floor screen W. 1590 fits Moving Wall Media.



With the Woodland foot set for floor screens, you can add your own touch to the design. These designed feet in molded wood with ash veneer and stylish metal fittings are available both with wheels to easily move the screen and without.

FOOT SET WOODLAND

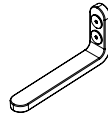

QQ

Foot set Woodland for Floorscreen A30

Foot in molded wood with ash veneer and metal fittings that fit A30 floor screen. 4 feet included.

643068-1 white*/ash	257.98
643068-2 black*/ash	257.98
643068-3 silver*/ash	257.98

RR

Foot set Woodland for Floorscreen A40/Sketch/Scribble

Foot in molded wood with ash veneer and metal fittings. 4 feet included.

643066-1 white*/ash	257.98
643066-2 black*/ash	257.98
643066-3 silver*/ash	257.98

* Colour indicates fittings.



Foot set in molded wood with ash veneer and metal fittings that fits floor screens. The wheels are lockable.

FOOT SET WOODLAND

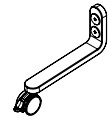

SS

Foot set Woodland with wheels for Floorscreen A30

Foot set in molded wood with ash veneer and metal fittings that fits A30 floor screen. 4 feet with wheels included. The wheels are lockable.

643067-1 white*/ash	335.43
643067-2 black*/ash	335.43
643067-3 silver*/ash	335.43

TT

Foot Set Slide-in Woodland with wheels for A40/Sketch/Scribble-Floor screen

Foot set in molded wood with ash veneer and metal fittings. 4 feet with wheels included. The wheels are lockable.

643065-1 white*/ash	335.43
643065-2 black*/ash	335.43
643065-3 silver*/ash	335.43

* Colour indicates wheels and fittings.

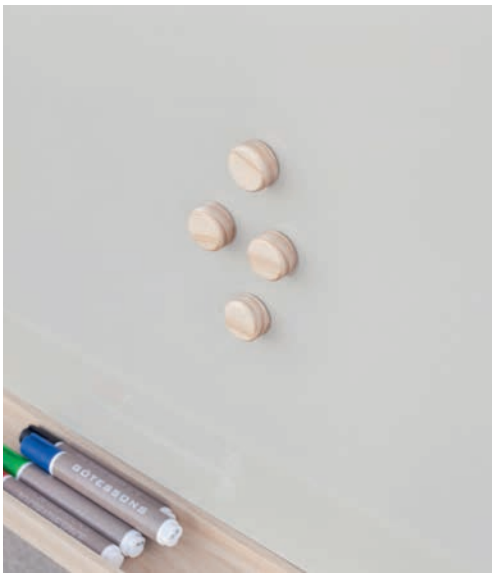

Magnets Woodland

4-pack magnets for Sketch Writing board. Extra strong magnets with wood cover in solid ash. Ø 25 H. 11

637122 ash 66.17



Pen holder Woodland

Extra strong magnet for good hold on Sketch Writing Board. Solid ash.

W. 180 H. 30 D. 80
637123 ash 92.87

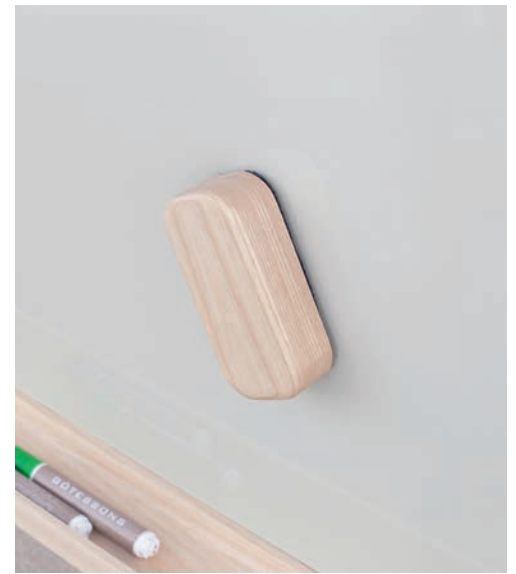

Eraser Woodland

Extra strong magnet. Felt is mounted on Hook & Loop tape, change when matted. Solid ash. W. 120 H. 33 D. 60

637121 ash 79.68

Whiteboard eraser felt refill 5 pcs

Mount on Hook & Loop tape.

637130 grey 5.96



Whiteboard pens, 4 pcs

Colours: blue, red, black, green.

637131 17.98



Pen shelf Woodland 1590 mm

Material: solid ash. W. 801 H. 83

637125 ash 160.00

Pen shelf Woodland 990 mm

Material: solid ash. W. 966 H. 83

637124 ash 160.00



Pen shelf for Sketch writing board 990 mm

Pen shelf to mount on writing board. W. 966 H. 57

637118-1 white -2 black -3 silver 40.43

Pen shelf for Sketch writing board 1590 mm

Pen shelf to mount on writing board. Only space for 1 shelf. W. 801 H. 57

637119-1 white -2 black -3 silver 40.43

Accessory kit for writing boards

Content: wiper, 4 pens and 10 magnets.

101050 75.96

STORYBOARD ECOSUND®

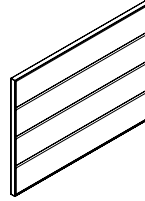

Storyboard EcoSUND

Acoustic Nonwoven Hush Blazer Lite

125600- W. 1600 H. 1200	675,11	782,77	931,38
125601- W. 2400 H. 1200	971,91	1052,98	1147,45

Colour frame. 1=white, 2=black, 3=grey

HOW TO ORDER STORYBOARD

Art.No - Colour frame - Colour fabric.

Example: 125600-1-567= Storyboard with white frame in blue Hush.

Mounting strip Dikt for frame 1600 mm

List for wall mount.

341600	W. 1320	17.87
--------	---------	-------

Mounting strip Dikt for frame 2400 mm

List for wall mount.

342400	W. 2120	26.49
--------	---------	-------

Important info: Storyboard can only be ordered in textiles Acoustic Nonwoven, Hush and Blazer Lite. See textiles and frames in textile chapter. For orders of W. 2400 mm, minimum quantity: 5 pcs.



The bulletin board for your documents. Attach documents with pins, on the metallic list or with magnets. All absorbents are 50 mm thick for good sound absorption and made of our unique core material EcoSUND. Choose textiles from Acoustic Nonwoven, Hush and Blazer Lite to match the rest of your furniture.

WRITING BOARD FOR SCREENIT A30 AND SOFAS



Writing board to hang over screens

Magnetic whiteboard in metal to hang over the screen.

648103	W. 700	H. 900	D. 53*	white	116.28
--------	--------	--------	--------	-------	--------

* Information: The depth indicates the dimensions of the shelf.



Magnetic writing board with painted surface to hang over ScreenIT A30 floor screens and Sofa Sound Booth. The board is easy to clean and has a practical built-in pen shelf. Can not be used on Sofa Silent Group.



Collage is a two-in-one solution combining good acoustics with a practical notice board. Collage is manufactured in six standard formats. All absorbents are 50 mm thick for good sound absorption and made of our unique core material EcoSUND. Choose colour from textiles Acoustic Nonwoven, Hush or Blazer Lite to match the rest of your furniture.



Collage concealed frame is a sound absorbing notice board. It improves the acoustics and is a practical tool at the same time.

COLLAGE ECOSUND®

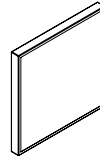

Collage EcoSUND	Acoustic Nonwoven	Hush	Blazer Lite
125700- W. 600 H. 600	193,40	291,81	332,77
125701- W. 1200 H. 600	216,06	318,40	375,96
125702- W. 1200 H. 900	260,21	354,04	419,04
125703- W. 1200 H. 1200	265,85	386,91	481,81
125704- W. 1600 H. 1200	348,94	477,23	557,45
125705- W. 2400 H. 1200	721,60	810,32	893,62

Colour frame. 1=white, 2=black, 3=grey

HOW TO ORDER COLLAGE

Art.No - Colour frame - Colour fabric/Acoustic Nonwoven.

Example: 125702-1-567= Collage with white frame in blue Hush.

Mounting strip Dikt for frame

List for wall mount.

346000	320 mm (for print/absorbent 600 mm)	12.13
349000	620 mm (for print/absorbent 900 mm)	13.09
341200	920 mm (for print/absorbent 1200 mm)	14.04
341600	1320 mm (for print/absorbent 1600 mm)	17.87
342400	2120 mm (for print/absorbent 2400 mm)	26.49

Facts: Can only be ordered in textiles Acoustic Nonwoven, Hush and Blazer Lite. See textile chapter.

For orders of W. 2400 mm, minimum quantity: 5 pcs.

COLLAGE ECOSUND® CONCEALED FRAME

Collage concealed frame

Collage concealed frame	Hush	Blazer Lite
125706- W. 600 H. 600	339,68	360,00
125707- W. 1200 H. 600	371,06	390,85
125708- W. 1200 H. 900	411,81	458,62
125709- W. 1200 H. 1200	547,34	607,77
125710- W. 1600 H. 1200	684,89	730,64
125711- W. 2400 H. 1200	816,60	901,49

HOW TO ORDER COLLAGE CONCEALED FRAME

Art.no - Textile.

Example: 125708-567 = Collage with concealed frame dressed with blue Hush.

Facts: Can be ordered in textiles Hush and Blazer Lite. Also possible to dress in other textiles upon request. See textiles in the textile chapter. For orders of W. 2400 mm, minimum quantity: 5 pcs.

Mounting strip Dikt for frame

List for wall mount.

346000	320 mm (for print/absorbent 600 mm)	12.13
349000	620 mm (for print/absorbent 900 mm)	13.09
341200	920 mm (for print/absorbent 1200 mm)	14.04
341600	1320 mm (for print/absorbent 1600 mm)	17.87
342400	2120 mm (for print/absorbent 2400 mm)	26.49





CEILING

A good sound environment has a direct connection to our wellbeing. We have sound absorbents that are designed to be mounted on the wall and ceiling and to suit all types of environments. Our absorbents are made of EcoSUND, a unique sound absorbing core material produced together with acousticians for optimal sound absorption. EcoSUND is available in several colours and our products can be chosen in their raw material, be dressed with textile, printed, cut into different shapes and customised to suit your needs.

ROOM DIVIDERS

Several of our ceiling mounted absorbents also work as excellent room dividers.

They can be mounted on rails or directly in the grid to create rooms within the room, absorb sound and at the same time improve the decor with their colour and shape. Create zones where you combine the softer sound with the visual effect.



Hanging from the ceiling, Pendula becomes an effective room divider that improves the acoustics in the room while also becoming a stylish interior detail.



PENDULA ECOSUND®

Pendula Cloud

Contents: 5 absorbers. Total height: 2370 mm. Mounts/Distances not included.

121400-	W. 2400	H. 400	D. 50	raw	936,28
121401-	W. 2400	H. 400	D. 50	dressed	1533,51

Consumption of distance packages 644002: The product can be mounted with a distance package directly in the ceiling bracket instead of a wire. It is recommended that there are several people during assembly.

Cloud: 4 packages for wire suspension, 5 packages for remote suspension.

Consumption of ceiling packages 644004/644005: 1 package.

Consumption of wire 644006: 1 package.

See below for distance packages.

See next page for ceiling mounts.

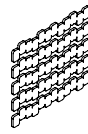

Pendula Pixel

Contents: 5 absorbers. Total height: 2170 mm. Mounts/Distances not included.

121410-	W. 2400	H. 400	D. 50	raw	936,28
121411-	W. 2400	H. 400	D. 50	dressed	1533,51

Consumption of distance packages 644002: The product can be mounted with a distance package directly in the ceiling bracket instead of a wire. It is recommended that there are several people during assembly.

Pixel : 6 packages for wire suspension, 8 packages for remote suspension.

Consumption of ceiling packages 644004/644005: 2 package.

Consumption of wire 644006: 2 package.

See below for distance packages.

See next page for ceiling mounts.



Pendula Wave

Contents: 4 absorbers. Total height: 1600 mm. Mounts/Distances not included.

121420-	W. 2400	H. 343	D. 50	raw	607,55
121421-	W. 2400	H. 343	D. 50	dressed	854,15

Colour code core material: white-1 black-2 grey-3 light grey-6

Consumption of distance packages 644002: The product can be mounted with a distance package directly in the ceiling bracket instead of a wire. It is recommended that there are several people during assembly.

Wave : 3 packages for wire suspension, 4 packages for remote suspension.

Consumption of ceiling packages 644004/644005: 1 package.

Consumption of wire 644006: 1 package.

See below for distance packages.

See next page for ceiling mounts.

HOW TO ORDER PENDULA CLOUD/PIXEL/WAVE RAW

1. Art.No - Colour core/raw. Example: 121400-2 = Pendula EcoSUND 800x400x50 with black core/raw.

HOW TO ORDER PENDULA CLOUD/PIXEL/WAVE WITH HUSH

1. Art.No - Colour textile - Edge colour (core/raw).

Example: 121401-567-1 = Pendula EcoSUND 800x400x50 with blue Hush and white edge (core/raw).

2. Order ceiling package. Choose T24 or Ceiling package angle mount.

Consumption 1 package/Cloud/Wave, 2 packages/Pixel.

3. Order wire (if the product is to be mounted with wire).

Consumption 1 package/Cloud/Wave, 2 package/Pixel.

4. Order distance packages, observe the correct number. See information for each product.

DISTANCE PACKAGE PENDULA

Distance package

Contains: 2 hangers and 4 metal pins. The sprint goes through holes in the EcoSUND plate. The distance is mounted between two Pendulas. Space between absorbers will be 145 mm.

644002-1	white	-2 black	-3 grey	15.85
----------	-------	----------	---------	-------





PENDULA ECOSUND®

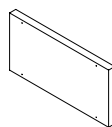

Pendula Square

125140-	W. 800	H. 400	D. 50	raw	29,04
125141-	W. 800	H. 400	D. 50	dressed	59,68
125142-	W. 800	H. 600	D. 50	raw	43,30
125143-	W. 800	H. 600	D. 50	dressed	95,85
125144-	W. 800	H. 800	D. 50	raw	61,91
125145-	W. 800	H. 800	D. 50	dressed	127,66
125146-	W. 800	H. 1200	D. 50	raw	87,13
125147-	W. 800	H. 1200	D. 50	dressed	195,64
125156-	W. 1600	H. 400	D. 50	raw	58,62
125157-	W. 1600	H. 400	D. 50	dressed	130,96
125158-	W. 1600	H. 600	D. 50	raw	90,43
125159-	W. 1600	H. 600	D. 50	dressed	195,64
125160-	W. 1600	H. 800	D. 50	raw	116,70
125161-	W. 1600	H. 800	D. 50	dressed	259,15
125162-	W. 1600	H. 1200	D. 50	raw	178,09
125163-	W. 1600	H. 1200	D. 50	dressed	390,64

Colour code core material: white-1 black-2 grey-3 light grey-6

The product needs to be mounted with the distance package Pendula and with an optional ceiling bracket, this is purchased separately. Large sizes of Pendula may require two people for assembly.



Pendula distance package

Contains: 2 hangers and 4 pins in metal.

The sprint goes through holes in the EcoSUND plate, the spacer is mounted in any ceiling bracket or between two Pendulas.

644001 - distance between absorbers 100 mm

644003 - distance between absorbers 400 mm

644001-1	L. 146	white	10.43
644001-2	L. 146	black	10.43
644001-3	L. 146	grey	10.43
644003-1	L. 446	white	24.68
644003-2	L. 446	black	24.68
644003-3	L. 446	grey	24.68

HOW TO ORDER PENDULA SQUARE RAW

Art.No - Colour core/raw. Example: 125140-2 = Pendula EcoSUND 800x400x50 with black core/raw.

HOW TO ORDER PENDULA SQUARE WITH HUSH

1.Art.No - Colour textile - Edge colour (core/raw). Example: 125141-567-1 = Pendula EcoSUND 800x400x50 with blue Hush and white edge (core/raw).

2. Order ceiling bracket and distance package.

CEILING MOUNT PENDULA

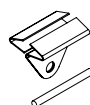

Ceiling kit T24

Contains: 2 pcs T24 clips, 2 pcs pins.

The sprint goes through holes in the EcoSUND plate.

644004-1 white -2 black -3 grey 26.17

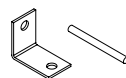

Ceiling kit angle mount

Contains: 2 angle brackets, 2 pins. For other ceilings than T24.

644005-1 white -2 black -3 grey 15.85



Wire kit

Contains: 2 wires, 2 pins

Wire to suspend absorbent from the ceiling. 2 meter, adjustable..

644006 34.47

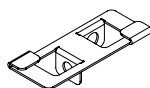

Adjustable mount T24

Contains: 2 brackets.

Adjustable, means that you can fold down two different tinplates to swing down products in two different directions. Can not be hung directly on EcoSUND.

642044-1 white 2 black -3 silver 7.13

Pendula is an updated version of Effekt Pendent. The panels come in two widths and are made in our sound absorbing core material EcoSUND. Can be mounted solitaire on the ceiling or built vertically as a room divider. An effective way to improve acoustics in a room without changing existing installations such as ventilation, cables, lamps etc. The product needs to be mounted with the Pendula distance package and with an optional ceiling bracket, which is ordered separately.



SKY SHORELINE ECOSUND®

Shoreline is a ceiling-mounted sound absorber that is manufactured in a thickness of 50 mm to create good sound absorption. It is made of our core material EcoSUND. Mounted with advantage in an open landscape office to effectively improve the acoustics and create a cosy feeling.



SKY ECOSUND®

Mounted with associated fittings that inserts into the plate's fibres. The edge is always raw. Raw material in white, black and grey or dress with textile Hush, the same on both sides.

SKY SHORELINE ECOSUND®

Sky Shoreline

Contents: 4 absorbers.

129900-	W. 2400	H. 400	D. 50	raw	610,00
129901-	W. 2400	H. 400	D. 50	dressed	853,72

SKY PIXEL ECOSUND®

Sky Pixel

Contents: 5 st absorbers.

121412-	W. 2400	H. 400	D. 50	raw	936,28
121413-	W. 2400	H. 400	D. 50	dressed	1533,51

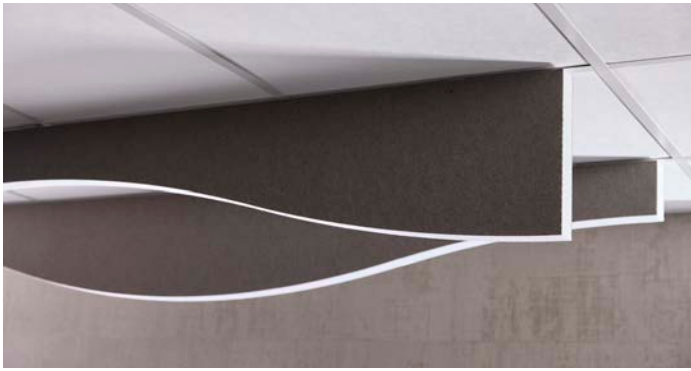

SKY DUNE ECOSUND®

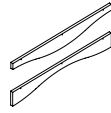

Sky Dune

Contents: 6 st absorbers, 3x2 different shapes.

121432-	W. 2400	H. 280	D. 50	raw	607,55
121433-	W. 2400	H. 280	D. 50	dressed	854,15



SKY CLOUD ECOSUND®



Sky Cloud

Contents: 5 st absorbers.

121402-	W. 2400	H. 400	D. 50	raw	936,28
121403-	W. 2400	H. 400	D. 50	dressed	1533,51



SKY WAVE ECOSUND®



Sky Wave

Contents: 4 absorbers.

121422-	W. 2400	H. 343	D. 50	raw	607,55
121423-	W. 2400	H. 343	D. 50	dressed	854,15

HOW TO ORDER SKY ECOSUND RAW

Art.No - Colour core. Example: 129900-2 = Sky Shoreline with black core.

HOW TO ORDER SKY ECOSUND WITH HUSH

Art.No - Colour textile - Edge colour (core).

Example: 129901-567-1 = Sky Shoreline with blue Hush and white edge (core).

2. Order mounting kit. Choose T24 or ceiling package angle bracket.

Consumption 1 package/product.

Colour code core material: white-1 black-2 grey-3 light grey-6

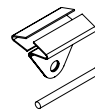

Ceiling kit T24

Contents: 2 pcs T24 clips, 2 pcs pins.

The sprint goes through holes in the EcoSUND plate.

644004-1	white	-2 black	-3 grey	26.17
----------	-------	----------	---------	-------

Number of ceiling package:

Dune: 9 package

Pixel: 8 package

Cloud: 5 package

Wave: 4 package

Shoreline: 6 package

We recommended that there are several people for mounting.

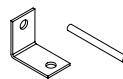

Ceiling kit angle mount

Contents: 2 angle brackets, 2 pins. For other ceilings than T24.

644005-1	white	-2 black	-3 grey	15.85
----------	-------	----------	---------	-------



Room divider Divido in molded felt creates life and screens open spaces. Consists of two panels that together form a neat pattern.



DIVIDO

Two vertically hanging panels á 800 mm/each. Made of molded felt from at least 55 % recycled PET. Fitting bag is purchased separately.

Divido Birch

121300-1	W. 1600	H. 2350	D. 8	gravel	459.68
121300-2	W. 1600	H. 2350	D. 8	slate	459.68
121300-8	W. 1600	H. 2350	D. 8	ivory	459.68
121305-1	W. 1600	H. 2450	D. 8	gravel	470.64
121305-2	W. 1600	H. 2450	D. 8	slate	470.64
121305-8	W. 1600	H. 2450	D. 8	ivory	470.64
121310-1	W. 1600	H. 2650	D. 8	gravel	481.60
121310-2	W. 1600	H. 2650	D. 8	slate	481.60
121310-8	W. 1600	H. 2650	D. 8	ivory	481.60

Divido Tree

121315-1	W. 1600	H. 2350	D. 8	gravel	459.68
121315-2	W. 1600	H. 2350	D. 8	slate	459.68
121315-8	W. 1600	H. 2350	D. 8	ivory	459.68
121320-1	W. 1600	H. 2450	D. 8	gravel	470.64
121320-2	W. 1600	H. 2450	D. 8	slate	470.64
121320-8	W. 1600	H. 2450	D. 8	ivory	470.64
121325-1	W. 1600	H. 2650	D. 8	gravel	481.60
121325-2	W. 1600	H. 2650	D. 8	slate	481.60
121325-8	W. 1600	H. 2650	D. 8	ivory	481.60

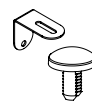

Divido attachment bag ceiling bracket

Contains: 6 pcs of ceiling mount, 6 pcs of clutch rivet.

121330-1	white	46.60
121330-2	black	46.60

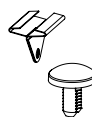

Divido attachment bag ceiling bracket T24

Included: 6 pcs of ceiling mount for T24, 6 pcs of clutch rivet.

121331-1	white	87,13
121331-2	black	87,13



Wire

Wire suspension. 2 m, adjustable. Consumption to Divido, 6 pcs.

20572	14,36/pc
-------	----------

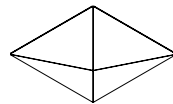

TIPI SYMMETRICAL

Tipi symmetrical

Textile ceiling decoration on wire stands for mounting in T24 support structure under fire-rated ceiling tile. Delivered in 1-pack.

644080-1	W. 594	H. 105	white	57.02
644080-2	W. 594	H. 105	grey	57.02
644080-3	W. 594	H. 105	beige	57.02

Tipi symmetrical

Textile ceiling decoration on wire stands for mounting in T24 support structure under fire-rated ceiling tile. Delivered in 6-pack.

644090-1	W. 594	H. 105	white	310.11
644090-2	W. 594	H. 105	grey	310.11
644090-3	W. 594	H. 105	beige	310.11

Give your ceiling the attention it deserves by creating an eye-catching look and harmony with textiles. The ceiling decoration Tipi brings playfulness and a striking feeling. Available as symmetrical or asymmetrical design and comes in colors white, grey and beige.

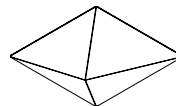

TIPI ASYMMETRIC

Tipi asymmetric

Textile ceiling decoration on wire stands for mounting in T24 support structure under fire-rated ceiling tile. Delivered in 1-pack.

644085-1	W. 594	H. 105	white	57.02
644085-2	W. 594	H. 105	grey	57.02
644085-3	W. 594	H. 105	beige	57.02

Tipi asymmetric

Textile ceiling decoration on wire stands for mounting in T24 support structure under fire-rated ceiling tile. Delivered in 6-pack.

644095-1	W. 594	H. 105	white	310.11
644095-2	W. 594	H. 105	grey	310.11
644095-3	W. 594	H. 105	beige	310.11

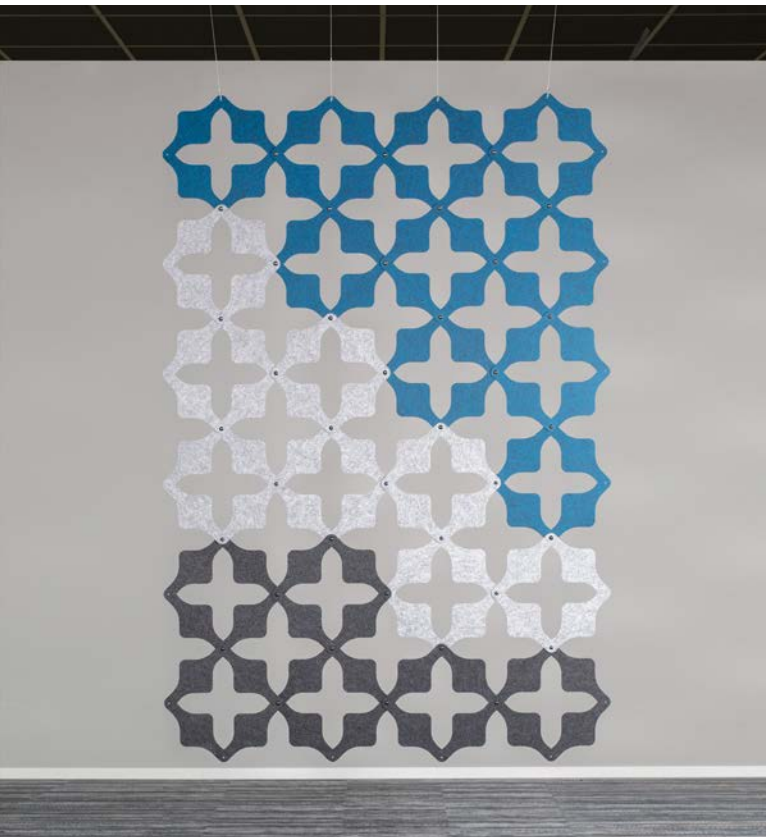

Create shielding between different workplaces and surfaces or a room in the room. Made from mould pressed felt, choose from several different colours.

COBOGO



Cobogo 12 pcs

12 pcs of vertical hanging panels for ceilings made of moulded felt, made of at least 55% recycled PET. Thickness: 5 mm.

121213-1	W. 372	H. 372	D. 5	gravel	253.09
121213-2	W. 372	H. 372	D. 5	slate	253.09
121213-3	W. 372	H. 372	D. 5	pine	253.09
121213-4	W. 372	H. 372	D. 5	moss	253.09
121213-5	W. 372	H. 372	D. 5	plum	253.09
121213-6	W. 372	H. 372	D. 5	cherry	253.09
121213-7	W. 372	H. 372	D. 5	cyan	253.09
121213-8	W. 372	H. 372	D. 5	ivory	253.09
121213-9	W. 372	H. 372	D. 5	hemp	253.09

Cobogo 3 pcs

3 pcs of vertical hanging panels for ceilings made of moulded felt, made of at least 55% recycled PET. Thickness: 5 mm.

121214-1	W. 372	H. 372	D. 5	gravel	84.04
121214-2	W. 372	H. 372	D. 5	slate	84.04
121214-3	W. 372	H. 372	D. 5	pine	84.04
121214-4	W. 372	H. 372	D. 5	moss	84.04
121214-5	W. 372	H. 372	D. 5	plum	84.04
121214-6	W. 372	H. 372	D. 5	cherry	84.04
121214-7	W. 372	H. 372	D. 5	cyan	84.04
121214-8	W. 372	H. 372	D. 5	ivory	84.04
121214-9	W. 372	H. 372	D. 5	hemp	84.04

Mounting: Assemble the panels with the included black rivets.

For suspension in T24 supports: 642041, purchased separately.

For hanging from ceilings without supporting structures: 121215 or swing from ceiling bracket with wire: 20572, purchased separately.

For wall mounting: 121216, purchased separately

Spare part clutch rivet 14-pack: 121217-2.





COBOGO

Ceiling mount Cobogo

Bracket to suspend Cobogo from the ceiling.

121215-1	white	6.17/pc
121215-2	black	6.17/pc



Mount for ceiling rail T24

When mounting in ceiling rail T24. See drawings at www.gotessons.com

642041-1	white -2 black -3 grey	13.09/pc
----------	------------------------	----------

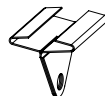

Wire

Wire suspension. 2 m, adjustable.

20572		14,36/pc
-------	--	----------



Wall mount Cobogo

Bracket to put Cobogo on the wall.

121216-1	white	6.17/pc
121216-2	black	6.17/pc



Clutch rivet Cobogo

Spare parts 14-pack clutch rivet.

121217-2	black	14.36
----------	-------	-------



Rail set with aluminum rail in black or white powder coating. 2 brackets/wire suspension per rail. Maximum load 2,5 kg/rail. It is possible to swing the rail from the ceiling with a cable and suspension (121227). Extendable with joint fittings (121226+121228).

Cobogo rail

Contains:

- 1 powder-coated aluminum rail, 2000 mm
- 1 twist stop with metal hook
- 2 plastic end caps
- 2 metal ceiling fittings
- 5 slides with metal hook

121218-1	white	183.51
121218-2	black	183.51

Accessories

Rail connector

Material: plastic

121226	W. 19	white	22.45
--------	-------	-------	-------

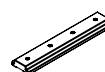

Rail wire suspension

Material: metal, L. 2000 mm, adjustable, 2-pack.

121227		white	43.19
--------	--	-------	-------



Rail 2000 mm

Material: powder coating

121228-1	W. 22	L. 2000	white	126.06
121228-2	W. 22	L. 2000	black	126.06



T24 fitting rail

Material: metal.

121229-1		white	21.38
----------	--	-------	-------

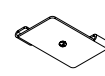

Wallmount rail

Material: metal.

121231-1		white	13.72
121231-2		black	13.72



Adjustable mount T24

Contains: 2 brackets.

Adjustable, means that you can fold down two different tinplates to swing down products in two different directions. Can not be hung directly on EcoSUND.

642044-1	white 2 black -3 silver	7.13
----------	-------------------------	------

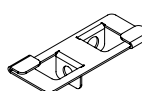



Improve the sound environment with Tiles Nova EcoSUND dressed in stylish textile Nova. Choose between six different colour combinations: we have chosen three unique colours for white EcoSUND and three unique colours for black EcoSUND for a harmonic result. Create patterns on the often forgotten area above your head with a 6-pack Tiles and easily continue with more packs or solo Tiles.



TILES NOVA ECOSUND®

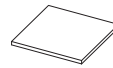

Tiles Nova EcoSUND

Nova 4945 on white EcoSUND

126802-773-1 W. 593 H. 593 D. 50 dressed 60.53

Nova 4844 on white EcoSUND

126802-774-1 W. 593 H. 593 D. 50 dressed 60.53

Nova 6650 on white EcoSUND

126802-775-1 W. 593 H. 593 D. 50 dressed 60.53

Nova 6252 on white EcoSUND

126802-776-1 W. 593 H. 593 D. 50 dressed 60.53

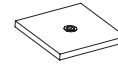

Tiles Nova EcoSUND with lamp

Nova 4945 on white EcoSUND

126805-773-1 W. 593 H. 593 D. 50 dressed 253.19

Nova 4844 on white EcoSUND

126805-774-1 W. 593 H. 593 D. 50 dressed 253.19

Nova 6650 on white EcoSUND

126805-775-1 W. 593 H. 593 D. 50 dressed 253.19

Nova 6252 on white EcoSUND

126805-776-1 W. 593 H. 593 D. 50 dressed 253.19

Mounting: see drawings on www.gotessons.com.
Dimmable LED, are installed by an electrician.

Tiles Nova EcoSUND 6 pcs

Nova 4945 on white EcoSUND 6 pcs

121222-773-1 W. 593 H. 593 D. 50 dressed 303.19/set

Nova 4844 on white EcoSUND 6 pcs

121222-774-1 W. 593 H. 593 D. 50 dressed 303.19/set

Nova 6650 on white EcoSUND 6 pcs

121222-775-1 W. 593 H. 593 D. 50 dressed 303.19/set

Nova 6252 on white EcoSUND 6 pcs

121222-776-1 W. 593 H. 593 D. 50 dressed 303.19/set

Can only be used in grids or together with In The Grid.
Colour combinations are predetermined for this product.
Textile Nova can only be used with this product.

NOVA BY SVENSSON



Colour 773
(4945)

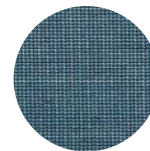

Colour 774
(4844)

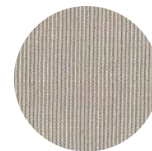

Colour 775
(6650)



Colour 776
(6252)

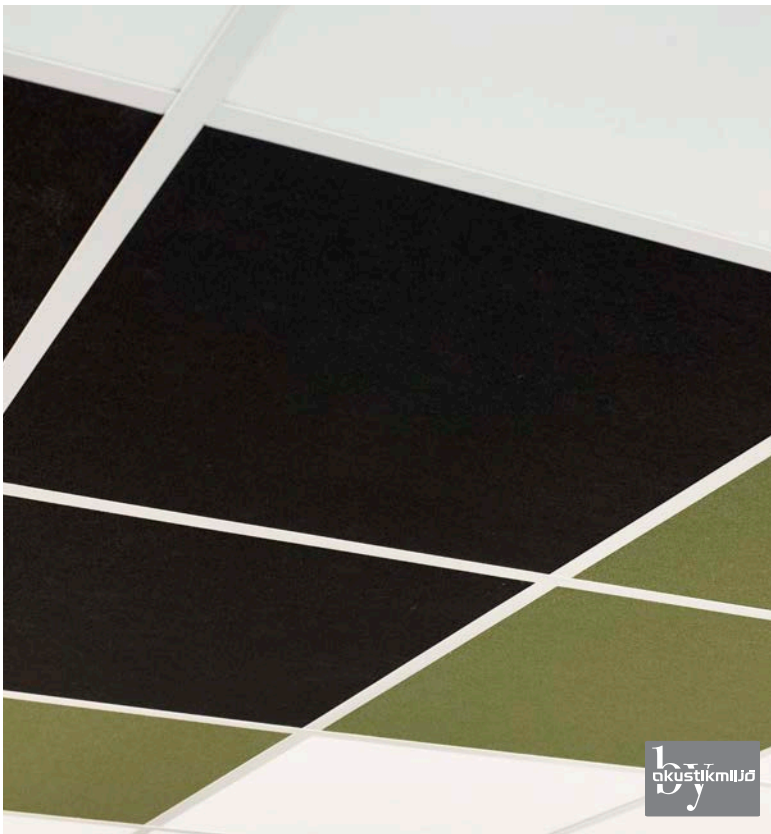

TILES ECOSUND® RAW / DRESSED

Tiles raw EcoSUND / Tiles dressed EcoSUND

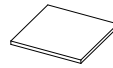

126800-	W. 593	H. 593	D. 50	raw	39,79
126801-	W. 593	H. 593	D. 50	dressed	55,00

Tiles raw EcoSUND with lamp / Tiles dressed EcoSUND with lamp

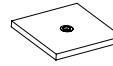

126803-	W. 593	H. 593	D. 50	raw	181,70
126804-	W. 593	H. 593	D. 50	dressed	233,09

Tiles raw EcoSUND 6-pack / Tiles Dressed EcoSUND 6-pack

121220-	W. 593	H. 593	D. 50	raw	200,64/set
121221-	W. 593	H. 593	D. 50	dressed	276,28/set

Add a personal touch to the ceiling with Tiles EcoSUND. EcoSUND is a unique core material made of 50% recycled polyester which dampens sound that bounces in a room. Tiles are available in raw EcoSUND in colours - white, black, grey or bronze brown, or dressed in textile Hush/Acoustic Nonwoven. Create patterns on the often forgotten area above your head with a 6-pack Tiles and easily continue with more packs or solo Tiles. Choose Tiles with a combined lamp for a smart 2-in-1 solution of acoustics and lighting.



TILES ACOUSTIC NONWOVEN ECOSUND®

Tiles Acoustic Nonwoven EcoSUND

126808-901	W. 593	H. 50	D. 593	white	43.40
126808-902	W. 593	H. 50	D. 593	black	43.40

Tiles Acoustic Nonwoven EcoSUND with lamp

126809-901	W. 593	H. 50	D. 593	white	193.30
126809-902	W. 593	H. 50	D. 593	black	193.30

Tiles Acoustic Nonwoven EcoSUND 6 pcs

121225-901	W. 593	H. 50	D. 593	white	225.53/set
121225-902	W. 593	H. 50	D. 593	black	225.53/set

Important info: Can only be ordered raw or dressed in Hush/Acoustic Nonwoven, see colours and core material on page 10+16.
Mounting: see drawings on www.gotessons.com.
Dimmable LED, are installed by an electrician.

ORDER TILES RAW ECOSUND

Order Tiles Raw EcoSUND (1-piece or 6-pack): Art.no - Core material
Example: 126800 - 1 = Tiles Raw EcoSUND in white

ORDER TILES ECOSUND DRESSED IN HUSH (1-piece or 6-pack)

Art.no - Colour of textile - Colour of edge (core material/raw)
Example: 126800 - 567 - 1 = Tiles Dressed EcoSUND in blue Hush and white edge (core material/raw).

Colour code core material: white-1 black-2 grey-3 light grey-6

Tiles with acoustic nonwoven fabric EcoSUND are sound absorbers for grids that add a personal touch to the ceiling. Made of the sound absorbing core material EcoSUND and covered with acoustic nonwoven.

IN THE GRID NATURE



In The Grid nature

Mounted directly in T-24 grids. Can not be combined with Tiles with lamp.

644070-20	W. 595	L. 595	H. 10	brass	119.79
644070-3	W. 595	L. 595	H. 10	silver	112.98



In The Grid nature är another version of the popular decorative metal grid that is mounted directly in the ceiling grid. It can be combined with already existing ceiling panels or with Götessons Tiles for good sound absorption: Nova, raw or dressed. Create a fun pattern on the ceiling or build zones over work stations - the possibilities are many!

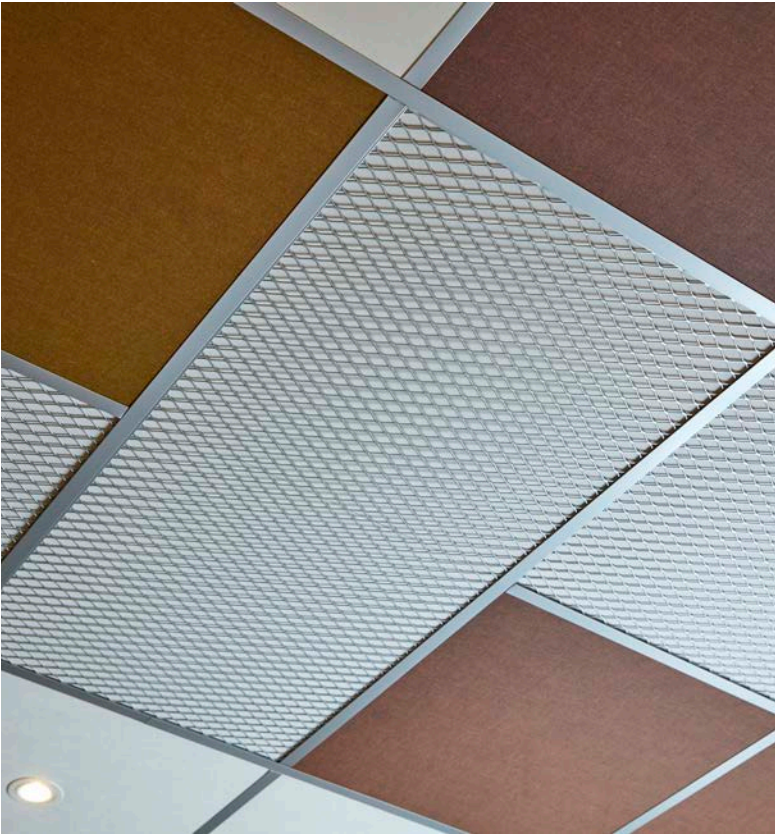

IN THE GRID

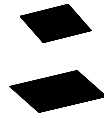

IN THE GRID

Available in two sizes and in colours silver and brass. Combine with Tiles.

644010-3	W. 595	H. 595	D. 4	silver	82.87
644010-20	W. 595	H. 595	D. 4	brass	84.26
644020-3	W. 1195	H. 595	D. 4	silver	130.53
644020-20	W. 1195	H. 595	D. 4	brass	133.19

Important info: Mounted straight in a T-24 grid.

In The Grid is a decorative wire frame in silver or brass, mounted straight into the ceiling grid, adding a luxurious touch to the room. Available in two sizes and can be combined with one or two Tiles for sound absorption. To match the rest of the interior, Tiles in all its variations can be used in In The Grid: Tiles Nova EcoSUND, Tiles dressed in Hush or Tiles in raw EcoSUND.



OFF THE GRID CEILING

Off the Grid ceiling

Off The Grid is only the metal frame with wires for suspension, 4 pcs included, 2 m long. Inner dimension depth 52 mm. With space for:
 2 x Tiles Raw/Dressed EcoSUND to art.no 644030-6 x TilesRaw/Dressed EcoSUND to art.no 644040-Suits also Off the Grid absorbent.
 Tiles, plants and lamps are bought separately.

644030-2	W. 1200	H. 600	D. 62	black	200.43
644030-3	W. 1200	H. 600	D. 62	silver	200.43
644030-20	W. 1200	H. 600	D. 62	brass	209.79
644040-2	W. 1800	H. 1200	D. 62	black	312.87
644040-3	W. 1800	H. 1200	D. 62	silver	312.87
644040-20	W. 1800	H. 1200	D. 62	brass	328.94

Off the Grid absorbent

Absorbents in EcoSUND adapted for Off the Grid wire mesh. Fits both the model for the ceiling and for the wall.

126120-	W. 1200	H. 600	D. 50	raw	76,17
126121-	W. 1200	H. 600	D. 50	dressed	120,00
126122-	W. 1800	H. 1200	D. 50	raw	278,83
126123-	W. 1800	H. 1200	D. 50	dressed	377,45

Off the Grid ceiling circle

Off The Grid is only the wire grid with wires for suspension, includes 4 wires, 2 m long. Inner dimension depth 52 mm. With room for Off the Grid absorbent. Plants and lights are purchased separately.

644103-2	Ø 772	D. 62	black	200.43
644103-3	Ø 772	D. 62	silver	200.43
644103-20	Ø 772	D. 62	brass	209.79
644105-2	Ø 1102	D. 62	black	251.49
644105-3	Ø 1102	D. 62	silver	251.49
644105-20	Ø 1102	D. 62	brass	261.38

Off The Grid absorbent EcoSUND circle

126124-	Ø 750	D. 50	raw	109,04
126125-	Ø 750	D. 50	dressed	174,79
126126-	Ø 1080	D. 50	raw	152,87
126127-	Ø 1080	D. 50	dressed	229,57

For Off the Grid rectangular: choose Tiles raw EcoSUND in white, black or grey raw material or cover in Hush.

For Off the Grid circle: choose Off the Grid absorbent in white, black or grey raw material or dress in Hush.

Mount for ceiling rail

When mounting in ceiling rail T24. See drawings at www.gotessons.com
 For Off the grid rectangular you need 4 mounts, for circle you need 1 mount.

642041-1	white -2 black	13.09/pc
----------	----------------	----------

Adjustable mount T24

Contains: 2 brackets.
 Adjustable, means that you can fold down two different tinplates to swing down products in two different directions. Can not be hung directly on EcoSUND.

642044-1	white 2 black -3 silver	7.13
----------	-------------------------	------

Important info: Can be mounted in any ceiling. Mounts 642041 or 642044 are needed for mounting in acoustic ceiling, are not included. Tiles with lighting are not recommended for Off the Grid.

LIGHTING

The Hut Lamp

5 m black textile-covered cord with switch and E27 socket. 3-step click attenuation, the light effect is easily changed by clicking on the switch. Lumens: 70 lm, 350 lm, 700 lm. Color temperature: 2100 K. Watt: 4 W. Mounting: earthed socket.

821020	142.77
--------	--------

Bright

5 m black textile-covered cord with switch and E27 socket. (Dimmer not included.) Lumens: max 470 lm. Color temperature: 2700 K. Watt: 4 W. Mounting: unearthed socket.

821025	187.77
--------	--------

Add an eye-catching detail in the room and suspend Off the Grid from the ceiling. Place Tiles EcoSUND in the metal frame for a sound dampening effect and combine with lamps and garlands from our wide assortment of lighting and artificial plants. The wire frame is made of 5 mm thick steel.



1-2 garlands are recommended per small Off The Grid. The double amount of garlands and 6 pcs Tiles are recommended for the big Off The Grid.



An effective sound absorbing ceiling panel. Can be ordered with or without the LED light. Available in various styles and sizes. Made of recycled material. Thickness 50 mm. Sound Off EcoSUND is also available laminated with Hush textile and as a wall absorber.



Improve the acoustics in the room with ceiling mounted and sound absorbing Sound Off Cloud. The cloud shaped sound absorbers are made of our unique core material EcoSUND and can be chosen in its raw state in different colours or dressed in colours from textile Hush. Create a dynamic impression by hanging the cloud at different wire lengths. For a 2-in-1 solution of sound absorption and lighting, choose the version with one or three LED lamps.

SOUND OFF ECOSUND® CEILING

SOUND OFF ECOSUND CEILING

Included: 2 m wire mount with loop and adjustable hook. Hook for ceiling not included. Dressed Sound Off EcoSUND is dressed on the underside. The edge will be raw.

Sound Off EcoSUND circular without lamps

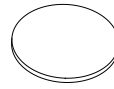

125300- Ø 800	D. 50	raw	130,96
125308- Ø 800	D. 50	dressed	215,74
125310- Ø 1100	D. 50	raw	176,17
125311- Ø 1100	D. 50	dressed	273,72
125320- Ø 1400	D. 50	raw	234,57
125324- Ø 1400	D. 50	dressed	345,96

Sound Off EcoSUND circular with one lamp

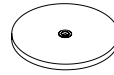

125318- Ø 800	D. 50	raw	328,40
125319- Ø 800	D. 50	dressed	416,81
125312- Ø 1100	D. 50	raw	360,43
125313- Ø 1100	D. 50	dressed	425,74
125314- Ø 1400	D. 50	raw	396,06
125315- Ø 1400	D. 50	dressed	476,17

Sound Off EcoSUND circular with three lamps

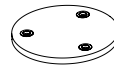

125303- Ø 800	D. 50	raw	526,91
125304- Ø 800	D. 50	dressed	613,72
125305- Ø 1100	D. 50	raw	570,43
125306- Ø 1100	D. 50	dressed	635,43
125309- Ø 1400	D. 50	raw	605,11
125307- Ø 1400	D. 50	dressed	685,21

SOUND OFF CLOUD ECOSUND®

Sound Off Cloud EcoSUND without lamp

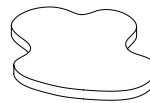

125100- Ø 800	D. 50	raw	130,96
125101- Ø 800	D. 50	dressed	215,74
125106- Ø 1100	D. 50	raw	176,17
125107- Ø 1100	D. 50	dressed	273,72
125112- Ø 1400	D. 50	raw	234,57
125113- Ø 1400	D. 50	dressed	345,96

Sound Off Cloud EcoSUND with 1 lamp

125102- Ø 800	D. 50	raw	328,40
125103- Ø 800	D. 50	dressed	416,81
125108- Ø 1100	D. 50	raw	360,43
125109- Ø 1100	D. 50	dressed	425,74
125114- Ø 1400	D. 50	raw	404,36
125115- Ø 1400	D. 50	dressed	476,17

Sound Off Cloud EcoSUND with 3 lamps

125104- Ø 800	D. 50	raw	526,91
125105- Ø 800	D. 50	dressed	613,72
125110- Ø 1100	D. 50	raw	570,43
125111- Ø 1100	D. 50	dressed	635,43
125116- Ø 1400	D. 50	raw	645,64
125117- Ø 1400	D. 50	dressed	685,21

Important info: mounting: see drawings on www.gotessons.com. Dimmable LED, are installed by an electrician.

HOW TO ORDER SOUND OFF ECOSUND RAW

Art.No - Colour core.

Example: 125300-2 = Sound Off EcoSUND circular without lamps Ø 800, black core.

HOW TO ORDER SOUND OFF ECOSUND WITH HUSH

Art.No - Colour textile - Edge colour (core/raw).

Example: 125308-567-1 = Sound Off EcoSUND circular without lamps Ø 800, with blue Hush and white edge. (core/raw).

See textile chapter for textile and core material.

Colour code core material: white-1 black-2 grey-3 light grey-6

Mount for ceiling rail

When mounting in ceiling rail T24. See drawings at www.gotessons.com. For Off the grid rectangular you need 4 mounts, for circle you need 1 mount.

642041-1 white -2 black

13.09/pc

Adjustable mount T24

Contains: 2 brackets.

Adjustable, means that you can fold down two different tinplates to swing down products in two different directions. Can not be hung directly on EcoSUND.

642044-1 white 2 black -3 silver

7.13



HANG OVER

See price ranges in textile chapter.



Hang Over small
678020- W. 598 H. 105

Pricer. 1	Pricer. 2	Pricer. 3	Pricer. 4
167,98	194,68	233,83	251,06

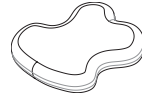

Hang Over large
678030- W. 810 H. 130

234,36	274,26	325,32	384,47
--------	--------	--------	--------

HOW TO ORDER HANG OVER

1. Select Hang Over size.
2. Select textile colour (see colour map at page 6-16).
3. Select zip colour (see colours on page 17).
4. Select ceiling mount.



Ceiling mount for Hang Over

Loop and wire 2 m.
642013

16.70



Mount for ceiling rail

When mounting in ceiling rail. See drawings at www.gotessons.com
642041-1 white -2 black

13.09/pc

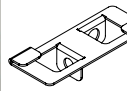

Adjustable mount T24

Contains: 2 brackets.

Adjustable, means that you can fold down two different tinplates to swing down products in two different directions. Can not be hung directly on EcoSUND.

642044-1 white 2 black -3 silver

7.13

Can only be ordered with a zip. Is mounted to the ceiling with screws or strung from the ceiling with an adjustable wire. Hooks and wires for the ceiling are not included. For exact measurements, see www.gotessons.com



NIVÅ ECOSUND® CEILING PANEL

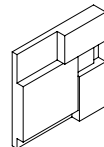

Nivå EcoSUND ceiling panel

125595- W. 593 H. 593
125596- W. 593 H. 593

raw	88,94
dressed	134,04

HOW TO ORDER NIVÅ ECOSUND RAW

Art.No - Colour core.

Example: 125595-2 = Nivå EcoSUND with black core.

HOW TO ORDER NIVÅ ECOSUND WITH HUSH

Art.No - Colour textile - Edge colour (core).

Example: 125596-567-1 = Nivå EcoSUND with blue Hush and white edge (core).

Colour code core material: white-1 black-2 grey-3 light grey-6

Facts: Nivå is manufactured in dimensions of 593x593 mm in two versions, one to work as a wall panel sound absorbent, the other to fit grid systems for ceilings. Thickness varies across the surface from 30-90 mm. Nivå dressed can only be ordered in Hush textile. See textiles and core material in textile chapter.

Nivå improves acoustics and its design makes it a feature in any room. The panels can be varied to form different patterns in different colours, with or without textile. Nivå is made of our unique core material EcoSUND. Our core material is available in four colours, and with the possibility of laminating with several different textiles, your ceiling becomes almost unique.



EFFEKT ECOSUND® PENDENT

Effekt EcoSUND Pendant

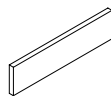

125120-	W. 1200	H. 300	D. 50	raw	54,47
125121-	W. 1200	H. 300	D. 50	dressed	101,06
125122-	W. 1200	H. 600	D. 50	raw	93,72
125123-	W. 1200	H. 600	D. 50	dressed	184,68
125124-	W. 1200	H. 900	D. 50	raw	146,28
125125-	W. 1200	H. 900	D. 50	dressed	278,62

HOW TO ORDER EFFEKT ECOSUND RAW

Art.No - Colour core/raw.

Example: 125122-2 = Effekt EcoSUND 1200x600x50 with black core/raw.

HOW TO ORDER EFFEKT ECOSUND WITH HUSH

Art.No - Colour textile - Edge colour (core/raw).

Example: 125123-567-1 = Effekt EcoSUND 1200x600x50 with blue Hush and white edge (core/raw).

Colour code core material: white-1 black-2 grey-3 light grey-6

Facts: Effekt EcoSUND dressed can only be ordered in Hush textile.
See textiles and core materia in the textile chapter.

EFFEKT HANG WIRES

Hang wire to hang Effekt EcoSUND Pendant from the ceiling or under already existing Effekt.



Hang wires Effekt EcoSUND Pendant 300 mm

Suitable for Effekt EcoSUND Pendant 1200x300x50.

643000-1 white -2 black -3 silver 30.00/2pcs

Hang wires Effekt EcoSUND Pendant 600 mm

Suitable for Effekt EcoSUND Pendant 1200x600x50.

646000-1 white -2 black -3 silver 31.81/2pcs

Hang wires Effekt EcoSUND Pendant 900 mm

Suitable for Effekt EcoSUND Pendant 1200x900x50.

649000-1 white -2 black -3 silver 35.21/2pcs

EFFEKT WIRE HOOKS

Wire hooks to get space when using Effekt EcoSund as a room divider.



Wire hooks Effekt EcoSUND Pendant 300 mm

Use to get space between Effect EcoSUND Pendant 1200x300x50 when used as a divider.

643001-1 white -2 black -3 silver 18.30/2pcs

Wire hooks Effekt EcoSUND Pendant 600 mm

Use to get space between Effect EcoSUND Pendant 1200x600x50 when used as a divider.

646001-1 white -2 black -3 silver 22.87/2pcs

Wire hooks Effekt EcoSUND Pendant 900 mm

Use to get space between Effect EcoSUND Pendant 1200x900x50 when used as a divider.

649001-1 white -2 black -3 silver 26.06/2pcs

Tip! For mounting Effekt Pendant from floor to ceiling, visit gotessons.se for more measurements regarding hang wires/wire hooks/clamp packets.

Effekt ceiling package

Content: S hook (silver), angle mount for ceiling and clips for ceiling rail.

643002-1 white -2 black 38.09/2pcs



Adjustable mount T24

Contains: 2 brackets.

Adjustable, means that you can fold down two different tinplates to swing down products in two different directions. Can not be hung directly on EcoSUND.

642044-1 white 2 black -3 silver 7.13

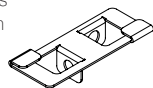

An effective way to improve the acoustics without having to change existing installations such as ventilation, cables, lights, etc. is to mount Effekt Pendant ceiling absorbers. An affordable solution that reduces noise reflexes and sound propagation in the room. Customize your absorbers by choosing from four core materials and laminate them with the Hush textile, available in several different colours.



Effekt is hung in hang wires that are connected and form a wall. An affordable solution that reduces noise reflexes and sound propagation in the room and divides the room into smaller rooms. Design your unique room divider by choosing from four different colours of EcoSUND, 3 different hang wires, and a variety of colours from the Hush textile. Effekt is not recommended for climbing.



Vertikal is an acoustic lamella blind, perfect for most types of spaces and is perfect to absorb sound that bounces against hard surfaces and large glass areas.

VERTIKAL ECOSUND®

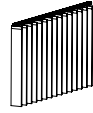

Vertikal EcoSUND

The lamellas are made of our unique sound absorbing core material EcoSUND in white, grey or black. Standard lamella width is 127 mm and height 3000 mm and maximum rail length is 3000 mm. Vertikal is easily adjusted in different positions and can be pushed aside if you wish and is therefore suitable wherever you wish to regulate reverberation. The absorber can be dressed on one or two sides.

121240-

Contact us for price

ORDER VERTIKAL

1. Specify length of the rail
2. Specify whether the blinds should be pulled to the left, right, or parted in the middle
3. Choose the position of the strings right / left. Distance string-floor 1500 mm
4. Select the type of mounts (standard, T-24, distance or wall mounted)
5. Enter the desired overall height (mm) from the top edge of the rail to the bottom edge of the lamella
6. Choose colour of the core material
7. Choose fabric for the front
8. Specify fabric or warmed surface for the back. For other measurements, please contact us.

Important info: when light textile is chosen against dark core material, the dark shines through. The edge will be raw.

Colour code core material: white-1 black-2 grey-3 light grey-6

MOUNTS	Distance to ceiling mounts.
Additional brackets for T-24 ceiling grids	Wall mounts Standard ceiling mounts

Mounting: Attach the rail that is delivered with the blinds and mount the lamella blinds. The rail can be mounted onto the wall or ceiling with the mounts you have chosen. At the bottom of the blinds a chain is fitted between the weights.



OPAQ BY SVENSSON



Colour 831
(6710)



Colour 832
(8000)



Colour 833
(8400)



Colour 834
(8500)



Colour 840
(4411)



Colour 841
(4831)



Colour 842
(5832)



Colour 843
(6750)



Colour 844
(3020)



Colour 845
(8200)



LOD ECOSUND®

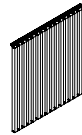

Lod EcoSUND

The Lod bars are 50x50 mm with an air gap of 40 mm. The rail is W: 45 mm and H: 25 mm. Maximum rail length is 3000 mm. Maximum bar length: 3000 mm. Lod is always bespoke to suit your environment's needs and is adjusted after the rail and bars' length.

121230-

Contact us for price

ORDER LOD

1. Specify length of the rail in mm
2. Select the type of mounts (standard, T-24, distance or wall mounted)
3. Enter the desired overall height from the top edge of the rail to the bottom of the bars
4. Select colour of core material
5. Select fabric for the front
6. Select fabric for the back.

Important info: when light textile is chosen against dark core material, the dark shines through. The edge will be raw.

Colour code core material: white-1 black-2 grey-3 light grey-6

MOUNTS

Additional brackets for T-24 ceiling grids

Distance to ceiling mounts.

Wall mounts

Standard ceiling mounts

Mounting: Mount the rail to the ceiling or wall with the selected mounts. The bars are then hung in the hangers on the rail's bottom. At the bottom of the bars, attach the stabilising plate to the bottom of the bars.

Lod is an acoustic lamina bar made of our unique core material EcoSUND in white, grey or black that is visible on the sides. The bars are always laminated on the front and back - choose from the colours from Opaq on this page. Because Lod is hung, it can replace curtains or be used as a room divider.



OPAQ BY SVENSSON



Colour 831
(6710)



Colour 832
(8000)



Colour 833
(8400)



Colour 834
(8500)



Colour 840
(4411)



Colour 841
(4831)



Colour 842
(5832)



Colour 843
(6750)



Colour 844
(3020)



Colour 845
(8200)





WALL

A good sound environment has a direct connection to our wellbeing. We have sound absorbents that are designed to be mounted on the wall and ceiling and to suit all types of environments. Our absorbents are made of EcoSUND, a unique sound absorbing core material produced together with acousticians for optimal sound absorption. EcoSUND is available in several colours and our products can be chosen in their raw material, be dressed with textile, printed, cut into different shapes and customised to suit your needs.



SlicePanel and SlicePanel Plant are two wall decorations in molded felt. One that is adapted for plants and one without the ability to add plants. The wavy pattern creates a cool visual effect and we recommend you to combine the two models. The model for plants you find in the pots and plants chapter. Design o4i.

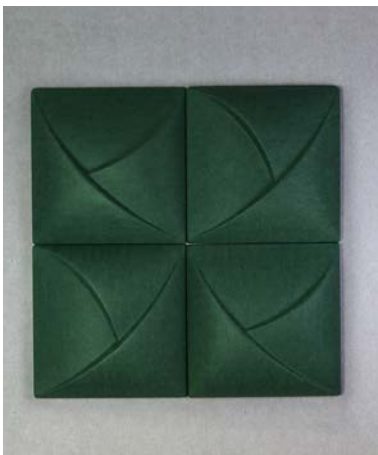

SLICEPANEL

SlicePanel

Moulded felt made of at least 55 % recycled PET. Mounted on the wall with rail, suspension included.

W. 580 H. 580 D. 140

121361-1	gravel	201.60
121361-2	slate	201.60
121361-3	pine	201.60
121361-4	moss	201.60
121361-5	plum	201.60
121361-6	cherry	201.60
121361-7	cyan	201.60
121361-8	ivory	201.60
121361-9	hemp	201.60



LEAFPANEL

LeafPanel

Moulded felt made of at least 55% recycled PET. Mounted on the wall with rail, suspension included.

W. 580 H. 580 D. 100

121360-1	gravel	201.60
121360-2	slate	201.60
121360-3	pine	201.60
121360-4	moss	201.60
121360-5	plum	201.60
121360-6	cherry	201.60
121360-7	cyan	201.60
121360-8	ivory	201.60
121360-9	hemp	201.60

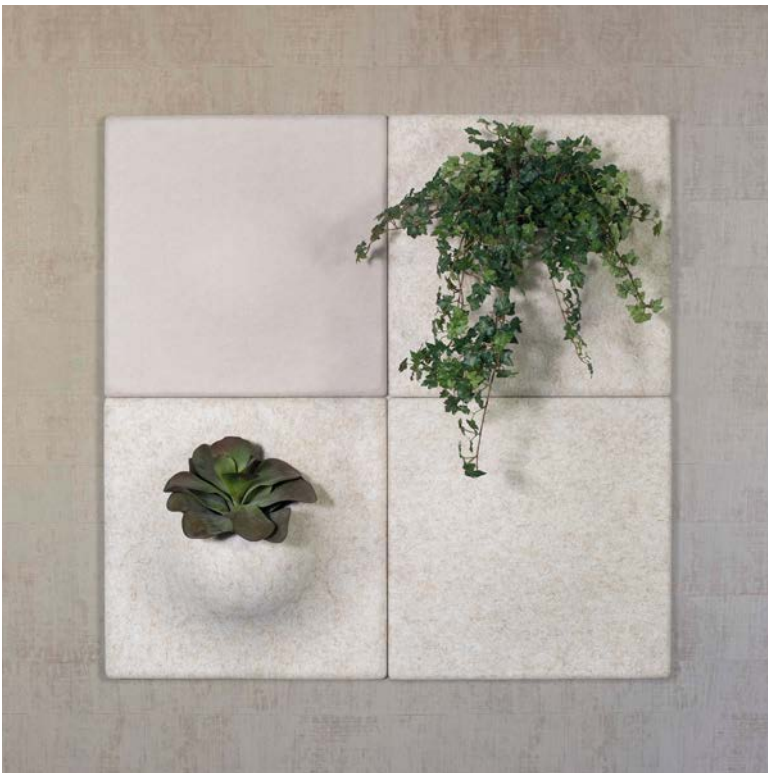

Create a striking wall in the room with the help of Wallpanels. Consists of molded felt and can be ordered in several different colors for more effect.

PLAINPANEL

PlainPanel

Moulded felt made of at least 55% recycled PET. Mounted on the wall with included wall mount.

W. 580 H. 580 D. 60

121211-1	gravel	162.45
121211-2	slate	162.45
121211-3	pine	162.45
121211-4	moss	162.45
121211-5	plum	162.45
121211-6	cherry	162.45
121211-7	cyan	162.45
121211-8	ivory	162.45
121211-9	hemp	162.45

EcoSUND for Wallpanels

Place behind Wallpanels for sound absorption. Only raw white EcoSUND.

W. 480 H. 570 D. 20

126400-1	white	20,74
----------	-------	-------



LANDSCAPE ECOSUND®

Cut out shapes in different thickness 8, 20, 40 and 50 mm. Dressed in various Hush textiles. Colours can not be changed. Frame in wood veneer.

Landscape Spring

Textile Hush: 61174, 68160, 61225, 68103.

121350-1	W. 524	H. 724	D. 60	ash	470.64
121350-2	W. 524	H. 724	D. 60	oak	470.64
121350-3	W. 524	H. 724	D. 60	walnut	470.64
121353-1	W. 1024	H. 724	D. 60	ash	645.96
121353-2	W. 1024	H. 724	D. 60	oak	645.96
121353-3	W. 1024	H. 724	D. 60	walnut	645.96

Landscape Coastline

Textile Hush: 66169, 60159, 66133, 60155.

121351-1	W. 524	H. 724	D. 60	ash	470.64
121351-2	W. 524	H. 724	D. 60	oak	470.64
121351-3	W. 524	H. 724	D. 60	walnut	470.64
121354-1	W. 1024	H. 724	D. 60	ash	645.96
121354-2	W. 1024	H. 724	D. 60	oak	645.96
121354-3	W. 1024	H. 724	D. 60	walnut	645.96

Landscape Sunset

Textile Hush: 64148, 63058, 61225, 61174, 63058.

121352-1	W. 524	H. 724	D. 60	ash	470.64
121352-2	W. 524	H. 724	D. 60	oak	470.64
121352-3	W. 524	H. 724	D. 60	walnut	470.64
121355-1	W. 1024	H. 724	D. 60	ash	645.96
121355-2	W. 1024	H. 724	D. 60	oak	645.96
121355-3	W. 1024	H. 724	D. 60	walnut	645.96



Honey is a playful and modular wall panel that can be varied to form different patterns in different colours, with or without textile. All panels have good sound absorbing properties. Honey is made with a straight edge and comes with velour backing for easy mounting with Hook & Loop tape. The sound absorbent is made from our unique core material EcoSUND. Our core material is available in four colours and with the ability to dress textiles in several colours your wall becomes almost unique.

HONEY ECOSUND® WALL PANEL

Honey EcoSUND wall panel

125520-	W. 600	H. 520	D. 20	raw	60,32
125521-	W. 600	H. 520	D. 20	dressed	77,34
125522-	W. 600	H. 520	D. 40	raw	63,83
125523-	W. 600	H. 520	D. 40	dressed	106,81
125524-	W. 600	H. 520	D. 50	raw	67,23
125525-	W. 600	H. 520	D. 50	dressed	123,83

HOW TO ORDER HONEY ECOSUND RAW

Art.No - Colour core.

Example: 125520-2 = Honey EcoSUND 600x520x20 with black core.

HOW TO ORDER HONEY ECOSUND WITH HUSH

Art.No - Colour textile - Edge colour (core).

Example: 125521-567-1 = Honey EcoSUND 600x520x20 with blue Hush and white edge. (core).

Important information: Honey is manufactured with a straight edge for even corners and velour backing for easy assembly with Hook & Loop tape. Dressed Honey can only be ordered in the textile Hush. The edge becomes raw. Our core material is available in four colors and with the option to dress with textile in several colors. See textiles and core materials in the textile chapter.

Colour code core material: white-1 black-2 grey-3 light grey-6

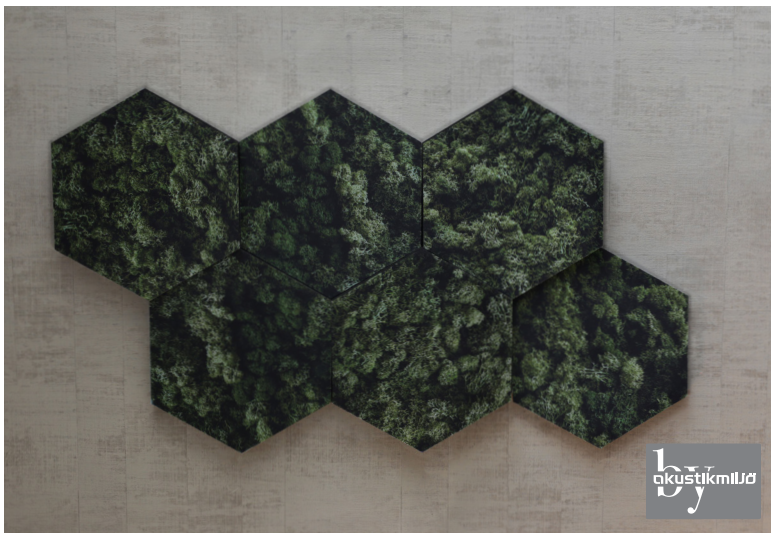

Honey print is a playful wall absorbent with beehive-shaped panels in three different thicknesses that together create an effective 3D feeling in the room. Honey print is available in several patterns inspired by nature.

HONEY ECOSUND® MOSS PRINT

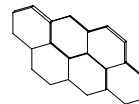

Honey Moss print

Comes in 6-packs, two of each thickness, 20, 40, 50 mm. Always the same motif, with reservation for certain pattern variation. Pattern matching is not required. Core material: black.

121340-2 W. 1819 H. 1050 D. 50

821.28



HONEY ECOSUND® RUST PRINT

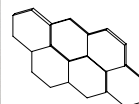

Honey Rust print

Comes in 6-packs, two of each thickness, 20, 40, 50 mm. Always the same motif, with reservation for certain pattern variation. Pattern matching is not required. Core material: black.

121341-2 W. 1819 H. 1050 D. 50

821.28

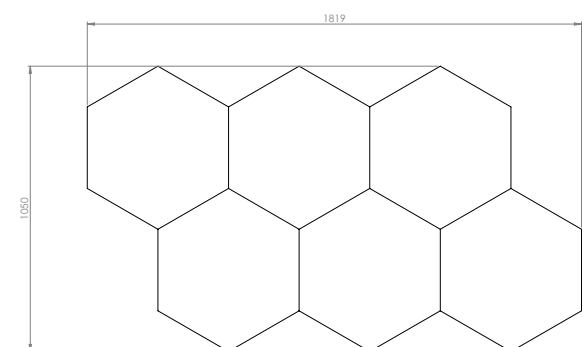



HONEY ECOSUND® CLIFF PRINT

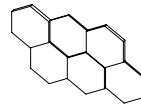

Honey Cliff print

Comes in 6-packs, two of each thickness, 20, 40, 50 mm. Always the same motif, with reservation for certain pattern variation. Pattern matching is not required. Core material: grey.

121342-3 W. 1819 H. 1050 D. 50

821.28



HONEY ECOSUND® AQUA PRINT

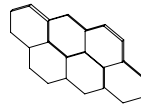

Honey Aqua print

Comes in 6-packs, two of each thickness, 20, 40, 50 mm. Always the same motif, with reservation for certain pattern variation. Pattern matching is not required. Core material: grey.

121343-3 W. 1819 H. 1050 D. 50

821.28

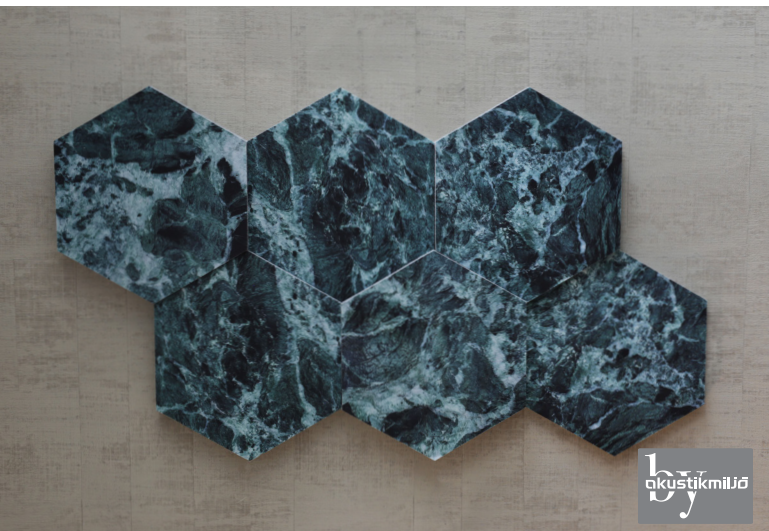

HONEY ECOSUND® HEAVEN PRINT

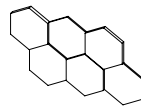

Honey Heaven print

Comes in 6-packs, two of each thickness, 20, 40, 50 mm. Always the same motif, with reservation for certain pattern variation. Pattern matching is not required. Core material: grey.

121344-3 W. 1819 H. 1050 D. 50

821.28

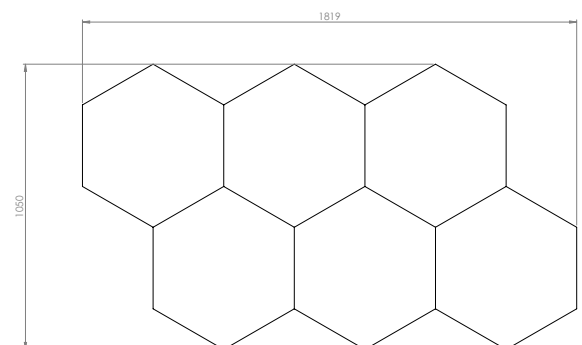

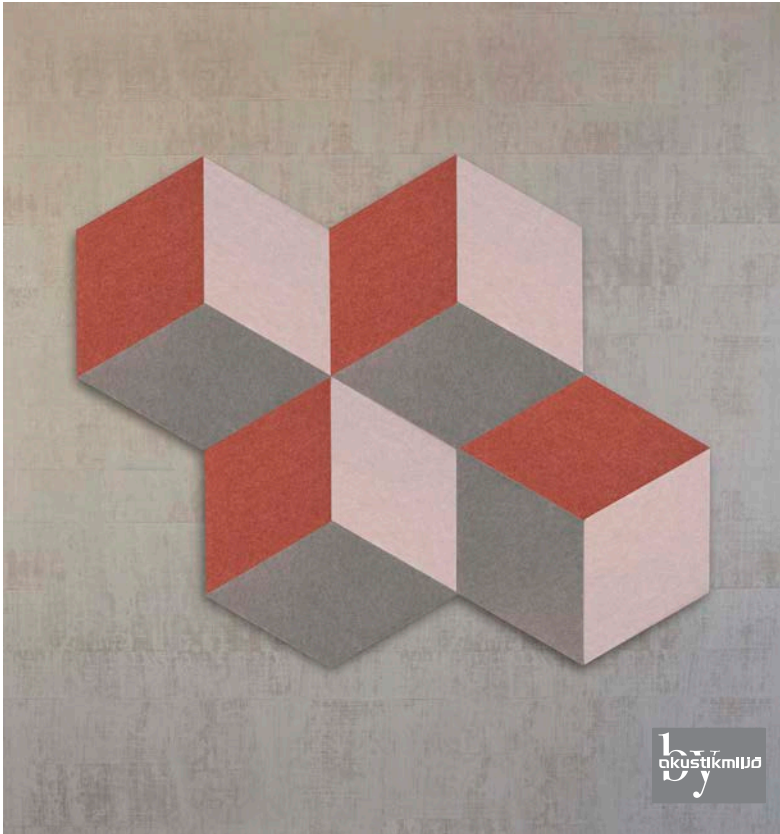

CUBISM ECOSUND®

Cubism

Sound absorbing wall absorbent. Core material EcoSUND.

Upholstered: Hush, edge in raw core, black, grey or light grey.

Thickness: 50 mm.

An absorbent/panel has the dimensions 450x260 mm.

There are 12 panels in a package that has 3 different color schemes.

Assembly: Velor-covered back and Hook & Loop tape.

The colour combinations are predetermined.

Dressed in colors from the Hush textile.

o 121290-2 Ash - Hush 4x60155, 4x60159, 4x60900 with black core

o 121291-2 Ocean - Hush 4x60155, 4x60159, 4x67046 with black core

o 121292-3 Lava - Hush 4x61225, 4x64148, 4x63058 with grey core

o 121293-6 Forest - Hush 4x68103, 4x61226, 4x68160 with light grey core

121290-2	ash	244.89/set
121291-2	ocean	244.89/set
121292-3	lava	244.89/set
121293-6	forest	244.89/set

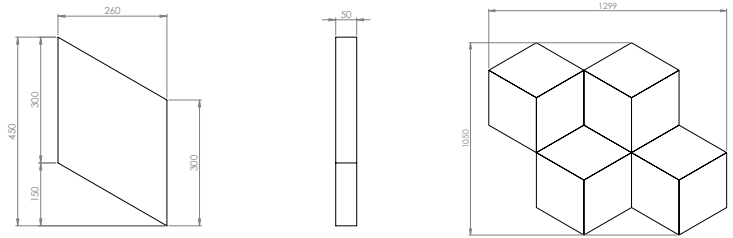

Cubism is a playful sound absorber with diamond-shaped panels that can be varied to create unique patterns in different colors.



WOODSTOCK ECOSUND®

Woodstock EcoSUND

The circles edges will be raw in white, black, grey or bronze brown.

121212-1	white	797.34
121212-2	black	797.34
121212-3	grey	797.34
121212-4	bronze brown	797.34
121212-6	light grey	797.34

Each packet includes 12 circles:

4 x Ø250x50 mm

4 x Ø300x40 mm

4 x Ø350x20 mm

To create a dynamic pattern, each size group is printed with a different image.

Facts: Wallmount with Hook & Loop tape included. The edge will be raw.

Colour code core material: white-1 black-2 grey-3 bronze brown-4 light grey-6

Bring nature inside. The circles are made with the environmentally friendly and sound absorbing material EcoSUND and are then printed with different images of trees' age rings. Combine the twelve circles in the order you find most harmonious and enjoy how good looking good acoustics can be. Perfect for settings like offices, conference rooms and hotels.

SOUND OFF ECOSUND® WALL

Sound Off EcoSUND wall

125384-	Ø 800	D. 50	raw	130,96
125385-	Ø 800	D. 50	dressed	215,74
125386-	Ø 1100	D. 50	raw	176,17
125387-	Ø 1100	D. 50	dressed	273,72
125388-	Ø 1400	D. 50	raw	234,57
125389-	Ø 1400	D. 50	dressed	345,96

Sound Off EcoSUND wall square

125390-	W. 600	H. 600	D. 50	raw	110,00
125391-	W. 600	H. 600	D. 50	dressed	183,30
125392-	W. 800	H. 800	D. 50	raw	149,36
125393-	W. 800	H. 800	D. 50	dressed	260,85
125394-	W. 1000	H. 1000	D. 50	raw	176,81
125395-	W. 1000	H. 1000	D. 50	dressed	299,89

125404-	W. 600	H. 600	D. 40	raw	98,09
125405-	W. 600	H. 600	D. 40	dressed	156,06
125408-	W. 800	H. 800	D. 40	raw	131,70
125409-	W. 800	H. 800	D. 40	dressed	208,83
125412-	W. 1000	H. 1000	D. 40	raw	169,47
125413-	W. 1000	H. 1000	D. 40	dressed	269,47

125406-	W. 600	H. 600	D. 20	raw	80,43
125407-	W. 600	H. 600	D. 20	dressed	131,70
125410-	W. 800	H. 800	D. 20	raw	120,96
125411-	W. 800	H. 800	D. 20	dressed	181,70
125414-	W. 1000	H. 1000	D. 20	raw	142,45
125415-	W. 1000	H. 1000	D. 20	dressed	235,74

Sound Off EcoSUND wall rektangulär

125416-	W. 600	H. 300	D. 50	raw	64,15
125417-	W. 600	H. 300	D. 50	dressed	103,30
125396-	W. 800	H. 600	D. 50	raw	122,45
125397-	W. 800	H. 600	D. 50	dressed	216,17
125398-	W. 1000	H. 600	D. 50	raw	126,28
125399-	W. 1000	H. 600	D. 50	dressed	237,87
125438-	W. 1200	H. 300	D. 50	raw	128,94
125439-	W. 1200	H. 300	D. 50	dressed	181,70
125400-	W. 1200	H. 600	D. 50	raw	134,79
125401-	W. 1200	H. 600	D. 50	dressed	277,02
125402-	W. 1200	H. 1000	D. 50	raw	177,98
125403-	W. 1200	H. 1000	D. 50	dressed	342,34

125418-	W. 600	H. 300	D. 40	raw	56,06
125419-	W. 600	H. 300	D. 40	dressed	80,43
125422-	W. 800	H. 600	D. 40	raw	114,15
125423-	W. 800	H. 600	D. 40	dressed	174,89
125426-	W. 1000	H. 600	D. 40	raw	123,62
125427-	W. 1000	H. 600	D. 40	dressed	207,34
125440-	W. 1200	H. 300	D. 40	raw	119,57
125441-	W. 1200	H. 300	D. 40	dressed	149,36
125430-	W. 1200	H. 600	D. 40	raw	132,98
125431-	W. 1200	H. 600	D. 40	dressed	233,09
125434-	W. 1200	H. 1000	D. 40	raw	174,89
125435-	W. 1200	H. 1000	D. 40	dressed	303,19

125420-	W. 600	H. 300	D. 20	raw	47,98
125421-	W. 600	H. 300	D. 20	dressed	66,81
125424-	W. 800	H. 600	D. 20	raw	101,91
125425-	W. 800	H. 600	D. 20	dressed	147,77
125428-	W. 1000	H. 600	D. 20	raw	118,09
125429-	W. 1000	H. 600	D. 20	dressed	179,04
125442-	W. 1200	H. 300	D. 20	raw	105,96
125443-	W. 1200	H. 300	D. 20	dressed	134,36
125432-	W. 1200	H. 600	D. 20	raw	123,62
125433-	W. 1200	H. 600	D. 20	dressed	211,38
125436-	W. 1200	H. 1000	D. 20	raw	162,87
125437-	W. 1200	H. 1000	D. 20	dressed	270,85

Facts: Wall mount with Hook & Loop tape included. The edge will be raw.

HOW TO ORDER SOUND OFF ECOSUND RAW

Art.No - Colour core.

Example: 125390-2 = Sound Off 600x600 with black core.

HOW TO ORDER SOUND OFF ECOSUND WITH HUSH

Art.No - Colour textile - Edge colour (core/raw)

Example: 125391-560-1 = Sound Off 600x600 in grey Hush and white edge (core/raw).

See textile chapter for textile and core material.

Distance

50 mm wall distances for Sound Off. 4 distances included. Screw for wall is included.

642057 D. 50

24.79



A very good sound absorber for hanging on the wall consisting of recycled material. Available in different types and sizes. Sound Off can only be ordered with Hush.

Colour code core material: white-1 black-2 grey-3 light grey-6



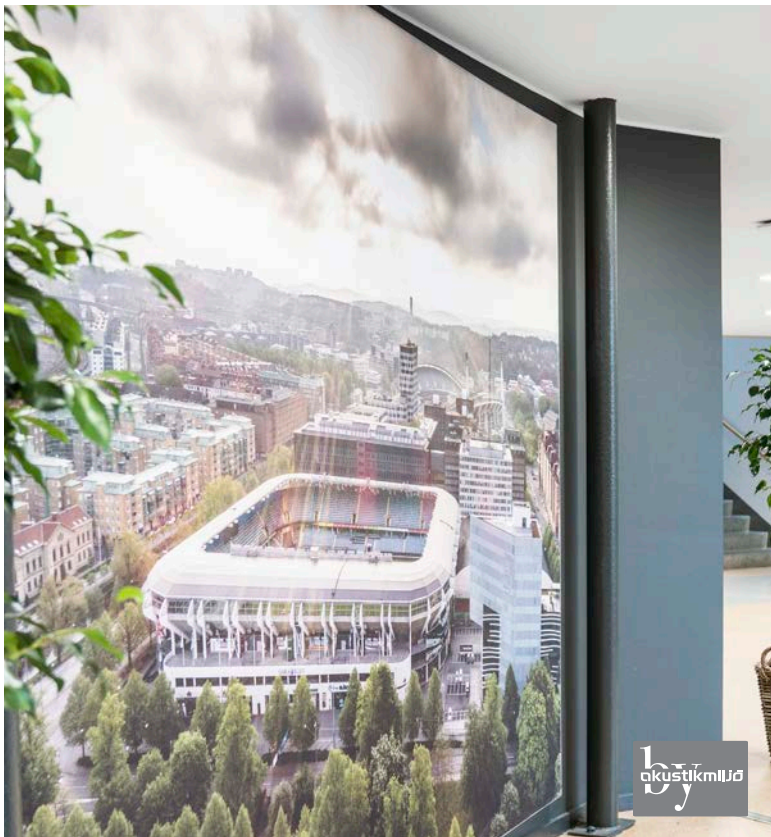

BIG PRINT ECOSUND®

Big Print EcoSUND

Thickness: 40 mm.

121250-

Contact us for price

ORDER BIG PRINT

Contact us for a quote. Picture choice: Choose pictures from our image bank or send in your own. Gotessons can also help you purchase images from an image bank.

Mounting: Big Print is delivered in parts. In any measurements up to 3 x 50 m, Big Print can be delivered in one piece without a splice. For bigger measurements, the print is made on several canvases. The aluminum profiles that make up the frame are mounted in straight angles on the wall and sound absorbents are attached with Hook & Loop tape directly onto the underlying wall. Wrap the printed canvas over the absorbent and insert the attached rubber strip into the groove of the aluminum profile to hold the canvas in place.

Big Print is more than an acoustic solution for your environment, it is an acoustic element that sets the tone in the whole room. Use your own or a bought illustration/photo to suit your interior. Big Print can be ordered in large as well as small formats with the benefit that a new printed canvas is all you need to order if you in the future want to change the image. The aluminium frame and EcoSUND absorbents remain in place.



ROYALTY FREE PICTURES

You can choose your own motif or choose pictures or illustrations from our image bank or one of many image banks on the internet.

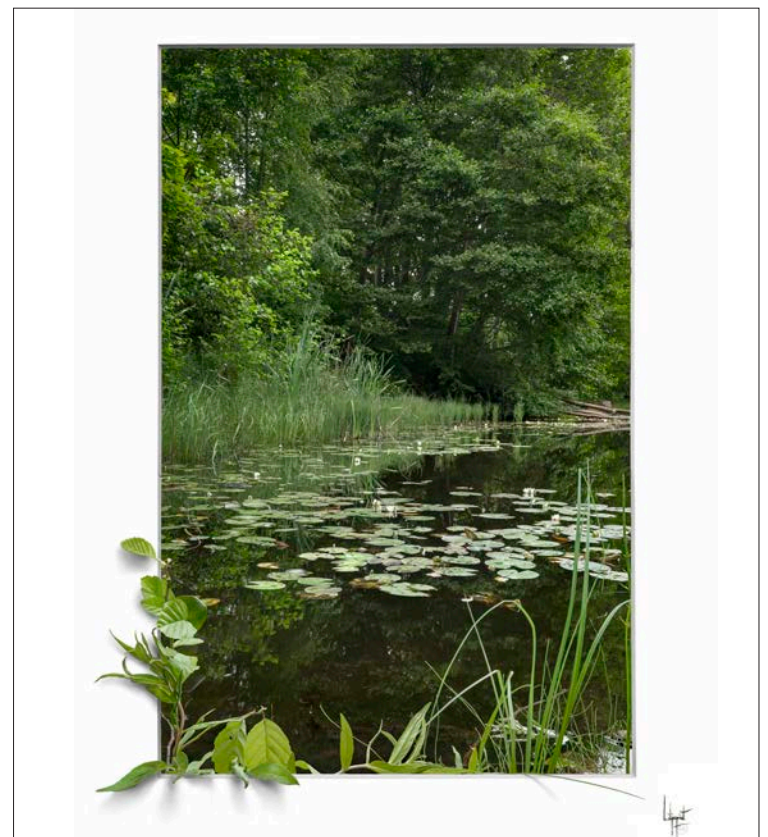

PICTURES WITH ROYALTY

Be inspired and choose motifs from our image bank with pieces from both innovative as well as traditional artists, photographers and photo artists, such as this piece of art from artist Mattias Liljeqvist.



Sound absorbing art is an easy way to create a personal atmosphere and at the same time improve the sound environment. With Print, you have the possibility to set the mood in the room with one or more pieces. Choose pictures from our image bank or send in your own picture. Gotessons can also help you buy images from an image agency, contact us for a quote. Print is available with a visible grey/white/black frame or with a straight cut edge with visible sides.



PRINT ECOSUND® WITH FRAME

Print EcoSUND with frame

Prices refer to our image bank and those sent in by the customer.

129803-	W. 600	H. 600	D. 50	393,51
129804-	W. 1200	H. 600	D. 50	508,94
129805-	W. 1200	H. 900	D. 50	744,89
129806-	W. 1200	H. 1200	D. 50	783,30
129807-	W. 1600	H. 1200	D. 50	1095,21
129808-	W. 2400*	H. 1200	D. 50	1419,26

ORDER PRINT ECOSUND WITH FRAME

1. Choose format
2. Choose frame colour (see page 16)
3. Choose image
4. Choose length of mounting strip.

Quotes are offered for Print with photographs and art by the artists Gotessons collaborate with, and images Gotessons buys.

Mounting strip Dikt for frame

List for wall mount.

346000	320 mm (for print/absorbent 600 mm)	12.13
349000	620 mm (for print/absorbent 900 mm)	13.09
341200	920 mm (for print/absorbent 1200 mm)	14.04
341600	1320 mm (for print/absorbent 1600 mm)	17.87
342400	2120 mm (for print/absorbent 2400 mm)	26.49

PRINT ECOSUND® WITH STRAIGHT CUT EDGE

Print EcoSUND with straight cut edge

Prices refer to our image bank and those sent in by the customer.

129809-	W. 600	H. 600	D. 50	268,19
129810-	W. 1200	H. 600	D. 50	368,62
129811-	W. 1200	H. 900	D. 50	607,87
129812-	W. 1200	H. 1200	D. 50	641,28

ORDER PRINT ECOSUND STRAIGHT CUT EDGE

1. Choose format
2. Choose colour of raw material EcoSUND (see page 16)
3. Choose picture

Quotes are offered for Print with photographs and art by the artists Gotessons collaborate with, and images Gotessons buys.

Colour code core material: white-1 black-2 grey-3 light grey-6

PRINT ECOSUND® WITH CONCEALED FRAME

Print with concealed frame

Prices refer to our image bank and those sent in by the customer.

129813-	W. 600	H. 600	D. 50	644,89
129814-	W. 1200	H. 600	D. 50	689,15
129815-	W. 1200	H. 900	D. 50	832,23
129816-	W. 1200	H. 1200	D. 50	955,74
129817-	W. 1600	H. 1200	D. 50	1215,74
129818-	W. 2400*	H. 1200	D. 50	1531,70

ORDER PRINT ECOSUND WITH CONCEALED FRAME

1. Choose format
2. Choose image
3. Choose length of mounting strip

Quotes are offered for Print with photographs and art by the artists Gotessons collaborate with, and images Gotessons buys.

Mounting strip Dikt for frame

List for wall mount.

346000	320 mm (for print/absorbent 600 mm)	12.13
349000	620 mm (for print/absorbent 900 mm)	13.09
341200	920 mm (for print/absorbent 1200 mm)	14.04
341600	1320 mm (for print/absorbent 1600 mm)	17.87
342400	2120 mm (for print/absorbent 2400 mm)	26.49

*For orders of W. 2400 mm, minimum quantity: 5 pcs. For quantity less than 5 pcs, we recommend Big Print.



Nivå improves acoustics and its design makes it a feature in any room. The panels can be varied to form different patterns in different colours, with or without textile. Our core material is available in four colours, and can be dressed in with several different textiles, your wall becomes almost unique. The thickness of the absorber varies over the surface from 30-90 mm in the cut rectangular and square patterns.



Fix the acoustics with smart sound absorbent Effekt EcoSUND Ceiling/Wall with clamps. For a discrete sound absorbing system in the ceiling or on the wall, two clamps per panel is mounted, the panel is slid inside the clamps and improves the sound environment immediately. Choose Effekt Ceiling/Wall in raw EcoSUND in colour white, black, grey or bronze brown. To match the rest of your interior, dress the panels in textile Hush.

NIVÅ ECOSUND® WALL PANEL

Nivå EcoSUND wall panel

125593-	W. 593	H. 593	raw	98,40
125594-	W. 593	H. 593	dressed	141,28

HOW TO ORDER NIVÅ ECOSUND RAW

Art.No - Colour core.

Example: 125593-2 = Nivå EcoSUND with black core.

HOW TO ORDER NIVÅ ECOSUND WITH HUSH

Art.No - Colour textile - Edge colour (core).

Example: 125594-567-1 = Nivå EcoSUND with blue Hush and white edge (core).

Facts: Nivå dressed can only be ordered in Hush textile. See textiles and core material in the textile chapter.

Colour code core material: white-1 black-2 grey-3 light grey-6

EFFEKT ECOSUND® CEILING/WALL

Effekt EcoSUND ceiling/wall

125130-	W. 1200	H. 600	D. 50	raw	88,30
125131-	W. 1200	H. 600	D. 50	dressed	153,19
125132-	W. 1200	H. 900	D. 50	raw	131,60
125133-	W. 1200	H. 900	D. 50	dressed	191,28

ORDER EFFEKT CEILING/WALL RAW:

Art.no - core material

Example: 125130-2 = Effekt EcoSUND in black

ORDER EFFEKT CEILING/WALL DRESSED IN HUSH

Art.no - Colour of textile - Colour of edge (core material/raw)

Example: 125131-567-1 = Effekt EcoSUND dressed in blue Hush and white edge (core material/raw)

Each panel is mounted with 2 clamps (not included). Dressed Effekt can only be ordered in textile Hush.

See page 6-14 for textile and core material.

Colour code core material: white-1 black-2 grey-3 light grey-6

Clamp 600 mm for Effekt EcoSUND ceiling/wall

Low clamp lies tight against the Effekt Ceiling/Wall EcoSUND.

W. 600 H. 56 D. 30

643090-1 white -2 black -3 silver

19.04/2pcs

Clamp 900 mm for Effekt EcoSUND ceiling/wall

Low clamp lies tight against the Effekt Ceiling/Wall EcoSUND.

W. 900 H. 56 D. 30

643091-1 white -2 black -3 silver

27.77/2pcs

Clamp air gap 600 mm for Effekt EcoSUND ceiling/wall

High clamp for 50 mm air gap behind the absorbent.

W. 600 H. 107 D. 30

643092-1 white -2 black -3 silver

26.49/2pcs

Clamp air gap 900 mm for Effekt EcoSUND ceiling/wall

High clamp for 50 mm air gap behind the absorbent.

W. 900 H. 107 D. 30

643093-1 white -2 black -3 silver

30.11/2pcs

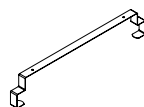
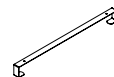



Sound absorbing 3D letters for hanging on the wall with Hook & Loop tape consisting of recycled polyester foam and dressed with Hush. Contact Gotessons for more information regarding other signs and sizes, etc. Sound Off letters can only be ordered with Hush. The edge will be raw.



Tell-Us improves the acoustics and enhances the interior design with its 3D effect. The sound absorbent is made of our unique core material EcoSUND. Tell-Us is as standard available with a grey, black or white frame and can be ordered with textile Hush. The textile is selected for its ability to allow the sound pass through to the acoustic panel to achieve maximum sound absorption.

SOUND OFF ECOSUND® LETTERS

Sound Off EcoSUND letters

The standard letter type is Arial Black. The standard height is 350 mm and thickness 50 mm. With Hook & Loop tape that is hammered or stapled to the wall.

120110-	H. 350	raw	55,00
120100-	H. 350	dressed	79,79

HOW TO ORDER LETTERS RAW:

Art.no - Type of letter / digit / character - Colour core.

Example: 120110-E-3 = Letter E in grey.

HOW TO ORDER LETTERS WITH HUSH:

Art.no - Type of letter / digit / character - Colour of textile - Colour core.

Example: 120100-E-569-1 = Letter E dressed with green Hush and white edge (core).

See textiles and core material in the textile chapter.

Colour code core material: white-1 black-2 grey-3 light grey-6

TELL-US ACOUSTIC WORLD MAP



Tell-Us EcoSUND

160120-	W. 1600	H. 1200	D. 50	763,62
240120-	W. 2400	H. 1200	D. 50	1080,43

HOW TO ORDER TELL-US

Art.No - Colour frame - Colour textile - Edge colour (core).

Example: 160120-1-567-1 = Tell-Us with white frame in blue Hush and white edge. (core).



Mounting strip Dikt for frame 1600 mm

List for wall mount.

341600	1320 mm (for print/absorbent 1600 mm)	17.87
--------	---------------------------------------	-------

Mounting strip Dikt for frame 2400 mm

List for wall mount.

342400	2120 mm (for print/absorbent 2400 mm)	26.49
--------	---------------------------------------	-------

Important info: Tell-Us can only be ordered in Hush textile. See textiles and core material in textile chapter. The edge will be raw.

For orders of W. 2400 mm, minimum quantity: 5 pcs.

Colour code core material: white-1 black-2 grey-3 light grey-6

SCREENIT A30 FLEXIBLE

ScreenIT A30 Flexible 650 mm, zipper on long side

See price ranges in textile chapter.

With seam			Pricer. 1	Pricer. 2	Pricer. 3	Pricer. 4
627080-	W. 800	H. 650	183,40	192,77	338,83	443,30
627120-	W. 1200	H. 650	245,85	276,91	398,83	505,74
627140-	W. 1400	H. 650	252,98	289,36	405,74	512,87
627160-	W. 1600	H. 650	255,96	302,02	408,62	515,74
627180-	W. 1800	H. 650	292,77	347,77	444,04	552,98
627200-	W. 2000	H. 650	374,26	406,28	522,02	633,83

With zip			Pricer. 1	Pricer. 2	Pricer. 3	Pricer. 4
627080-	W. 800	H. 650	227,02	236,81	380,53	486,81
627120-	W. 1200	H. 650	289,36	320,96	440,64	549,15
627140-	W. 1400	H. 650	296,60	333,40	447,45	556,49
627160-	W. 1600	H. 650	299,47	346,06	450,32	559,26
627180-	W. 1800	H. 650	336,60	391,81	486,06	596,60
627200-	W. 2000	H. 650	417,55	450,43	550,43	677,45

ScreenIT A30 Flexible 800 mm, zipper on long side

With seam			Pricer. 1	Pricer. 2	Pricer. 3	Pricer. 4
625080-	W. 800	H. 800	253,83	267,23	448,51	667,02
625120-	W. 1200	H. 800	316,17	330,00	535,64	702,66
625140-	W. 1400	H. 800	323,40	364,15	632,45	802,13
625160-	W. 1600	H. 800	326,28	397,77	692,87	873,30
625180-	W. 1800	H. 800	363,30	435,32	770,74	944,68
625200-	W. 2000	H. 800	444,47	471,38	825,53	1072,77

With zip			Pricer. 1	Pricer. 2	Pricer. 3	Pricer. 4
625080-	W. 800	H. 800	297,45	311,06	490,43	710,43
625120-	W. 1200	H. 800	359,57	373,83	577,34	746,28
625140-	W. 1400	H. 800	366,91	408,09	674,26	845,64
625160-	W. 1600	H. 800	369,89	441,60	734,68	917,02
625180-	W. 1800	H. 800	406,91	479,26	812,66	988,19
625200-	W. 2000	H. 800	487,98	515,43	867,23	1116,28

HOW TO ORDER A30 FLEXIBLE/WALL

1. Select screen size.
2. Select screen colour (see colours on page 6-16).
3. Select zip or seam colour (see colours on page 17).
4. Select Wall package.

Wall package

List for wall mount.

641063	500 mm	22.66
641064	1000 mm (for screens longer than 1800 mm)	42.77

COLLAGE CONCEALED FRAME

Collage concealed frame

			Hush	Blazer Lite
125706-	W. 600	H. 600	339,68	360,00
125707-	W. 1200	H. 600	371,06	390,85
125708-	W. 1200	H. 900	411,81	458,62
125709-	W. 1200	H. 1200	547,34	607,77
125710-	W. 1600	H. 1200	684,89	730,64
125711-	W. 2400	H. 1200	816,60	901,49

HOW TO ORDER COLLAGE CONCEALED FRAME

Art.no - Textile.

Example: 125708-567 = Collage with concealed frame dressed with blue Hush.

Facts: Can be ordered in textiles Hush and Blazer Lite. Also possible to dress in other textiles upon request. See textiles in the textile chapter. For orders of W. 2400 mm, minimum quantity: 5 pcs.

Mounting strip Dikt for frame

List for wall mount.

346000	320 mm (for print/absorbent 600 mm)	12.13
349000	620 mm (for print/absorbent 900 mm)	13.09
341200	920 mm (for print/absorbent 1200 mm)	14.04
341600	1320 mm (for print/absorbent 1600 mm)	17.87
342400	2120 mm (for print/absorbent 2400 mm)	26.49



The screen can be used as a desk, floor and wall screen. This screen is without holes and can be ordered with height adjustable mounting brackets. The screen can then easily be moved up and down with an Allen key. See video on www.gotessons.com.



Collage concealed frame is a sound absorbing notice board. It improves the acoustics and is a practical tool at the same time.



Off The Grid is a wire frame for wall mounting. Combine with Off the grid absorbent in coated or raw EcoSUND alternatively with Tiles EcoSUND. Add plant garlands to give the room an eye-catching detail.

OFF THE GRID WALL

Off the Grid wall

Off The Grid is only the metal frame with hanging clips for wall included. Suits Off the grid absorbent. Inner dimension depth 52 mm.

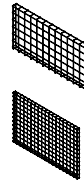

644100-2	W. 1200	H. 600	D. 62	black	180,21
644100-3	W. 1200	H. 600	D. 62	silver	180,21
644100-20	W. 1200	H. 600	D. 62	brass	190,11
644101-2	W. 1800	H. 1200	D. 62	black	289,79
644101-3	W. 1800	H. 1200	D. 62	silver	289,79
644101-20	W. 1800	H. 1200	D. 62	brass	300,74

Off the Grid absorbent

Absorbents in EcoSUND adapted for Off the Grid wire mesh. Fits both the model for the ceiling and for the wall.

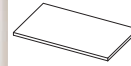

126120-	W. 1200	H. 600	D. 50	raw	76,17
126121-	W. 1200	H. 600	D. 50	dressed	120,00
126122-	W. 1800	H. 1200	D. 50	raw	278,83
126123-	W. 1800	H. 1200	D. 50	dressed	377,45

Off the Grid wall circle

Off The Grid is only the wire grid with hanging clips for wall mounting. With space for Off the Grid absorbent. Inner dimension depth 52 mm.

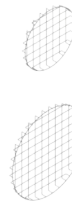

644102-2	Ø 772	D. 62	black	180,21
644102-3	Ø 772	D. 62	silver	180,21
644102-20	Ø 772	D. 62	brass	190,11
644104-2	Ø 1102	D. 62	black	213,09
644104-3	Ø 1102	D. 62	silver	213,09
644104-20	Ø 1102	D. 62	brass	222,98

Off The Grid Absorbent EcoSUND circle

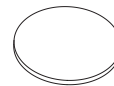

126124-	Ø 750	D. 50	raw	109,04
126125-	Ø 750	D. 50	dressed	174,79
126126-	Ø 1080	D. 50	raw	152,87
126127-	Ø 1080	D. 50	dressed	229,57

Choose Tiles Raw EcoSUND in white, black or grey or dressed in Hush. See colours in textile chapter.

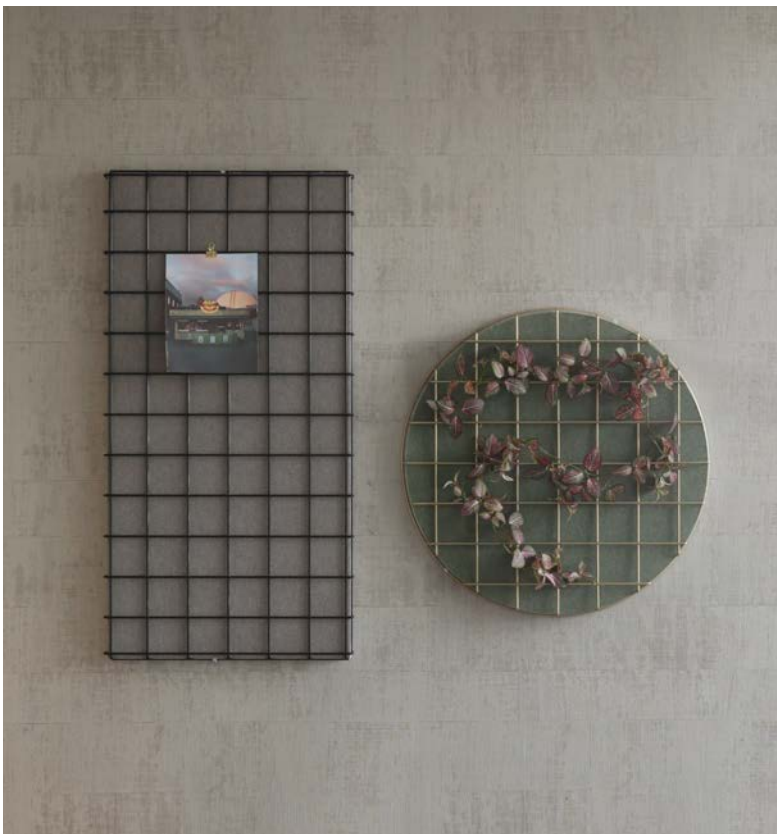



RUM 238

ROSA

DIM 220

ROSA

LÄNGLIVAT

CHRISTIANSONS



STORAGE

Create order with smart storage units with sound absorbing qualities. Thanks to smartdesign such as cable management, place for the TV, writing board and electric sockets, the needs are met for many types of spaces. Create zones and rooms within the room, move around thanks to the mounted wheels or build a meeting point with the storage at its center. Creative spaces see the possibilities!



SCREENIT WARDROBE

Sound absorbing booth for hanging clothes. Perfect for the modern office or for other public spaces. Built with A30 floor screens and clothes rail Ø 25 in black or white lacquered metal.



SCREENIT WARDROBE

ScreenIT Wardrobe

Constructed with wooden frame, 30 mm sound absorber and 5 mm foam laminated textile. Total thickness 40 mm. Straight corners, radius 10. Adjustable feet. Size assembled 1280x1800 mm.

W. 1280 H. 1800 D. 640

See price ranges on page 6-16.

1190180-	Pricer. 1 1760,64	Pricer. 2 1892,66	Pricer. 3 2122,34	Pricer. 4 2705,11
----------	----------------------	----------------------	----------------------	----------------------

Clothes rail for ScreenIT Wardrobe

Clothes rail in Ø 25 metal pipe including bracket in 4 mm sheet metal.

Maximum load 25 kg.

L. 1192

648050-1	white	140.21
648050-2	black	140.21

How to order ScreenIT Wardrobe:

1. Art. no - textile (see textiles on page 10-16).

Example: ScreenIT Wardrobe - Tonal 126 1190180 - 126 (seam like textile).

2. Order clothes rail, choose colour.

SIGN

Of course should a hanger look good! After all, the hanger is not always hidden under jackets, coats or other outdoor. Sign is the hanger with soft forms that suits well to Hang in There/ScreenIT Wardrobe.

Sign Hanger

Powder coated in metal with soft forms. Delivered in 4-pack.

W. 420 H. 215 D. 7

891072-1	white	81.60
891072-2	black	81.60

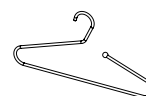
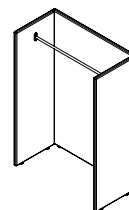



HANG IN THERE

Hang In There is a minimalistic clothes rail with knobs and room for hangers. The design allows it to fit in at offices as well as school and lobbies. For more room to hang items, two Hang In There can be mounted together with an extension rod.

Hang In There

Material: powder coated steel.
L. 1000 W. 450 H. 1625 D. 600

891070-1	white	481.17
891070-2	black	481.17

Hang In There, extension rod

Connects 2 pcs Hang In There. Material: powder coated steel.
Max load: 25 kg. L. 1000

891071-1	white	47.45
891071-2	black	47.45

Can be ordered in other colours, contact Götessons for a quote.

SIGN

Of course should a hanger look good! After all, the hanger is not always hidden under jackets, coats or other outwear. Sign is the hanger with soft forms that suits well to Hang in There/ScreenIT Wardrobe.

Sign Hanger

Powder coated in metal with soft forms. Delivered in 4-pack.
W. 420 H. 215 D. 7

891072-1	white	81.60
891072-2	black	81.60





MOVING WALL TOWER

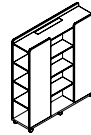

Moving Wall Tower

Wooden details in laminate.
W. 1650 H. 1800 D. 450

See price ranges on page 6-16.

	Pricer. 1	Pricer. 2	Pricer. 3	Pricer. 4
110020- ash	4010,96	4559,26	5231,91	5815,64
110021- oak	4010,96	4559,26	5231,91	5815,64
110022- walnut	4010,96	4559,26	5231,91	5815,64
110023- white	4010,96	4559,26	5231,91	5815,64

Important info: measurements incl. wheels. The product is, in its basic design, assembled at delivery. Holes for cables in the bottom.

Moving Wall Tower is the tallest of the three versions and built with A30 screens for good noise absorption. The furniture is easily moved thanks to braking and lockable wheels. Tower has shelves on both short sides and in the middle of one long side - excellent for storage and design. On the top shelf in each end there is a cable grommet to draw cables inside the furniture, these can be exchanged for Power Grommet for easy access to electricity. There is an opening with a lid on top for access inside Tower. Tower, Bridge and Media are great in combination with each other.



MOVING WALL BRIDGE

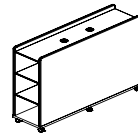

Moving Wall Bridge

Wooden details in laminate.
W. 1650 H. 1400 D. 450

See price ranges on page 6-16.

	Pricer. 1	Pricer. 2	Pricer. 3	Pricer. 4
110010- ash	3170,43	3789,36	4677,34	5268,72
110011- oak	3170,43	3789,36	4677,34	5268,72
110012- walnut	3170,43	3789,36	4677,34	5268,72
110013- white	3170,43	3789,36	4677,34	5268,72

Important info: measurements incl. wheels. The product is, in its basic design, assembled at delivery. Holes for cables in the bottom.

Power Grommet Twist that can be mounted in the product, see chapter Electrical Accessories: art.no 700532-1, -2, -3 / 702532-1, -2, -3 / 700332.

HOW TO ORDER MOVING WALL TOWER/BRIDGE:

Art. no - textile.

Example: Moving Wall Tower - Bond 755 110020 - 755 (seam like textile).

Bridge is one of three models in the series Moving Wall. It's a room divider on lockable wheels. The furniture is built with A30 screens and therefore an excellent sound absorbent. On the top, 2 pcs cable grommets are mounted for cables to be easily drawn inside the furniture. If needed, Power Grommet can be mounted instead.



Media is one out of three room dividers and storage units in the Moving Wall series. It has shelves on the short sides and in two sections on the front, hidden behind sliding doors with a lock. The front it also prepared for mounting a TV and the back for a Sketch Writing board, see Sketch in the Whiteboard chapter. Built with A30 screens, Media is also a great sound absorbent and a flexible interior element thanks to braking and lockable wheels. 2 pcs cable grommets are mounted on top and 1 pc in the center where the TV is mounted in order for cables to easily be hidden.

MOVING WALL MEDIA

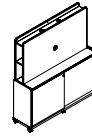

Moving Wall Media

Reinforced screen for mounting of TV screen. Wooden details in laminate. Max width TV: 65". Max weight TV: 35 kg.

W. 1650 H. 1800 D. 450

See price ranges on page 6-16.

	Pricer. 1	Pricer. 2	Pricer. 3	Pricer. 4
110030- ash	5693,72	6346,81	7229,36	7605,64
110031- oak	5693,72	6346,81	7229,36	7605,64
110032- walnut	5693,72	6346,81	7229,36	7605,64
110033- white	5693,72	6346,81	7229,36	7605,64

Important info: measurements incl. wheels. The product is, in its basic design, assembled at delivery. Holes for cables in the bottom.

HOW TO ORDER MOVING WALL MEDIA:

Art. no - textile.

Example: Moving Wall Media - Bond 755 110030 - 755 (seam like textile)

TV mount Moving Wall Media

Bracket in metal. 2 mounts included.

610611	black	108.40
--------	-------	--------

Sketch writing board floor screen

Writing board in glass to mount on floor screen and Moving Wall Media. Screws included. Glass 4 mm. Designed for screen 1600 mm.

101016	W. 1590 H. 990 D. 4	white	1038.94
101016-1	W. 1590 H. 990 D. 4	sand	1139.47
101016-2	W. 1590 H. 990 D. 4	mist	1139.47
101016-3	W. 1590 H. 990 D. 4	olive	1139.47
101016-4	W. 1590 H. 990 D. 4	ocean	1139.47
101016-5	W. 1590 H. 990 D. 4	rhubarb	1139.47
101016-6	W. 1590 H. 990 D. 4	lilac	1139.47
101016-7	W. 1590 H. 990 D. 4	harvest	1139.47





TEXTILE BOX

Textile box in light grey that fits the Moving Wall storage system, but works just as well independently.

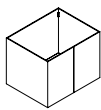

Textile box

Material: fiberboard. Dressed with Hush light grey 60155.

Delivered as a flat pack.

W. 365 H. 500 D. 460

110044

light grey

189.36



BOX UNIT FOR MOVING WALL

This box unit unit with a lockable door are a practical and stylish contribution to Moving Wall Bridge and Moving Wall Tower. Choose between the laminates ash, white, oak or walnut.

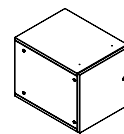

Box unit for Moving Wall

Material: Wood details in laminate. Equipped with lock and adjustable hinges. Can be obtained both right- and left-handed. Two keys included. Mounted separately. Not suitable for Moving wall Media.

110040

ash

384.79

110041

white

384.79

110042

oak

384.79

110043

walnut

384.79

Out. meas: W. 383 H. 385 D. 496.

In. meas: W. 347 H. 349 D. 478.



BRINGIT LAPTOP BAG

BringIT is a storage bag in black felt material with practical compartments for your laptop, folders and personal belongings. The bag is perfect for the activity-based office, you can easily transport all your belongings in a smooth way. Carry the computer with you in the bag to the meeting room, office or hang it at the workplace on a hook, purchased separately. Made from 100 % recyclable polyester.

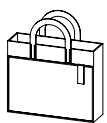

BringIT Laptop Bag

Laptop bag in felt material with compartment on the outside, one divider in the middle on the inside and 2 compartments inside.

W. 380 H. 310 D. 110

640086

black

145.43

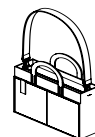

BringIT + storage bag

Laptop bag in felt material with compartment on the outside, one divider in the middle on the inside and two compartments inside. Shoulder strap and two handles. With zipper.

W. 380 H. 310 D. 110

640087

black

172.55



Hook with screws

Hook to be mounted under the desk. Screws included.

W. 40 H. 53 D. 58

671088-1

white

14.89

671088-2

black

14.89

671088-3

silver

14.89



Look

Only fits ScreenIT A30 screens. Lacquer and MDF are always white. Leather is always light beige, material: IMOLA. *

637127	white, brown leather	151.91
637132-1	white	118.51

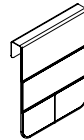

Pocket

Only fits ScreenIT A30 screens. 2 smaller pockets, 1 larger pocket. Leather is always light beige; material: IMOLA. *

637126	brown leather	125.32
--------	---------------	--------

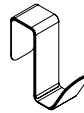
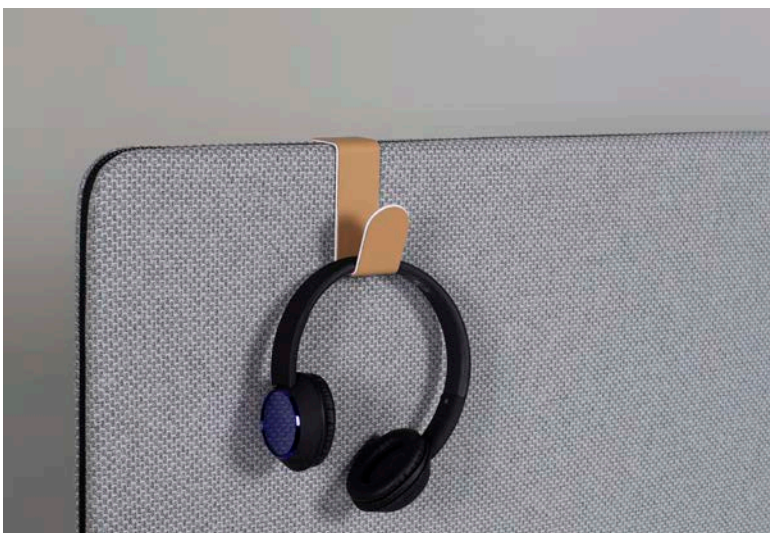

Hook

Only fits A30 screens. Lacquer is always white. Leather is always light beige, material: IMOLA. *

637129	white, brown leather	52.45
637134-1	white	20.53

*Imola= 50 % polyester, 30 % bomull, 20 % resirkulert skinn.





TABLES

Round or rectangular, large or small. Or why not foldable? Adapt the table to the interior and needs and not the other way around. Here is the new No Pocket Table and our round table Sit Around together with the transforming furniture iQseat where the backrest is easily transformed into a small work table.

SOFT SEATING

Soft seating stools at the office that act as an extra seat for visitors and used for private storage. Comfortable sofas with high backrests creating sheltered privacy, a place to meet or retreat. Soft lounge furniture for a short nap to quickly get some new energy for the next meeting. Seating for all kind of environments where you can design and build your own creative space.



SANDY SOFA

Sandy modular sofa, produced by JOOY Design Studio. Create creative, easily accessible seating surfaces in various playful combinations. The Sandy sofa consists of two unique modules that are easily connected and can create a variety of combinations.



SANDY SOFA

Constructed of MDF, covered with foam and textile.
Base in oak, ash, walnut, black or white laminate.

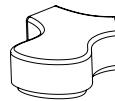

Sandy middle section

W. 1450 H. 460 D. 1260

647600-

Pricer. 1	Pricer. 2	Pricer. 3	Pricer. 4
1502,45	1558,30	1670,00	1949,26

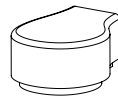

Sandy outer section

W. 990 H. 460 D. 785

647601-

999,79	1055,64	1167,34	1279,04
--------	---------	---------	---------

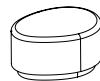

Sandy pouf

W. 945 H. 460 D. 745

647602-

888,09	898,94	943,94	1167,34
--------	--------	--------	---------



Sandy sofa with pouf

A complete sofa with 1x middle section, 2x outer sections and 1x pouf.

All sections in the same textile and the same laminate.

W. 2600 H.460 D. 2170

647603-

3568,94	3680,64	4015,74	4350,85
---------	---------	---------	---------

Prices apply to colours on page 6-16. Textiles that can be selected:

Pricer. 1: Omega, Pearl, Event Screen +, Mica, Slope, Tonal
Pricer. 2: Houston Reflect, Lido, Rivet, Kaiman, Noble lux, Era
Pricer. 3: Bond, Blazer, Synergy, Ally
Pricer. 4: Remix 3, Illusion

Laminate

910 ash
911 oak
912 walnut
913 white
914 black

How to order Sandy:

1: Choose Sandy section. Example: 647600 (middle section).

2: Choose textile for Sandy. Example: 647600-338 (Pearl 338 Java).
Colour on textile = color on seam.

3: Choose color on laminate. Example: 647600-338-910 (ash laminate).



SANDY TABLE

Sandy table designed by JOOY Design studio. Fits perfectly with the Sandy sofa but also with other seating furniture. The asymmetrical, oval and modern shape makes the table the obvious choice in the lounge.



SANDY TABLE



Sandy table

Table top with laminate.

Metal stand in black or white.

Both bottom plate and table top in the same shape.

W. 740 H. 560 D. 940

647610-1	ash/white	776.38
647610-2	ash/black	776.38
647611-1	white/white	776.38
647611-2	white/black	776.38
647612-1	oak/white	776.38
647612-2	oak/black	776.38
647613-1	walnut/white	776.38
647613-2	walnut/black	776.38
647614-1	black/white	776.38
647614-2	black/black	776.38



ash



white



oak

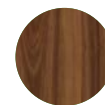

walnut



black



ROMBOWORK

With RomboWork you get another function to the smart and useful Rombo series of seating furniture and pots. An easily accessible workspace that can be moved around, if you choose RomboWork on wheels. Place in groups of three with their backs to each other.



ROMBOWORK

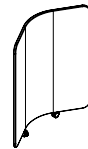

RomboWork screen

Contains: screen with wheels.
W. 1000 H. 1160 D. 250

	Pricer. 1	Pricer. 2	Pricer. 3	Pricer. 4
647350-	738,83	792,02	850,53	956,91



RomboWork table

Contents: table top in laminate. The table top is lacquered on the underside and edge in the same color as the base. Metal base.
W. 990 H. 720 D. 500

647360-1	ash/white	652.87
647360-2	ash/black	652.87
647361-1	oak/white	652.87
647361-2	oak/black	652.87
647362-1	walnut/white	652.87
647362-2	walnut/black	652.87
647363-1	white/white	569.15
647363-2	white/black	569.15
647364-1	black/white	569.15
647364-2	black/black	569.15

How to order RomboWork:

1: Choose textile and seam for RomboWork Screen.
Example: 647350-470-206.

2: Choose colour at RomboWork Table.
Example: 647364-1.

RomboWork is assembled by the customer.



ROMBOPLANTER

RomboPlanter is a textile-covered pot that can be filled with plants. Available in two different heights for the possibility of nice arrangements. Designed by Henrik Kjellberg and Jon Lindström from o4i Design Studio.



ROMBOPLANTER

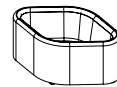

RomboPlanter 450 mm
W. 1000 H. 450 D. 650

647175-	Pricer. 1 1063,30	Pricer. 2 1116,49	Pricer. 3 1169,68	Pricer. 4 1222,87
---------	----------------------	----------------------	----------------------	----------------------



RomboPlanter 475 mm with wheels

647176- with wheels	1169,68	1222,87	1276,06	1329,26
---------------------	---------	---------	---------	---------

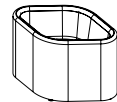

Rombo Planter 650 mm
W. 1000 H. 650 D. 650

647177-	1329,26	1382,45	1435,64	1488,83
---------	---------	---------	---------	---------



RomboPlanter 675 mm with wheels

647178- with wheels	1435,64	1488,83	1542,02	1595,21
---------------------	---------	---------	---------	---------

Important information:

RomboPlanter is made up of: MDF, covered with foam and textile.

Waterproof pot included.

The wheels are always black, lockable.

Specify the article number as follow:

RomboPlanter - Colour of textile (Seam will be similar to textile colour).



ROMBOSEAT

A stylish furniture that makes it easy to decorate thanks to its unique shape. Seating that can be ordered free standing, with table, with screen or with table and screen. Dress with optional textile for seating furniture. Tables and screens are ordered in separate article numbers.



ROMBOSEAT WITH WHEELS

A stylish portable seating furniture that makes it easy to decorate thanks to its unique shape. With RomboSeat with lockable wheels you can create flexible sitting areas that can be moved around. The seating furniture can be ordered: freestanding, with table, screen or with both table and screen. Designed by Henrik Kjellberg and Jon Lindström from o4i Design Studio.

ROMBOSEAT

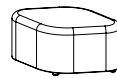

RomboSeat free seating

Includes: RomboSeat
W. 1000 H. 450 D. 650
647160-

Pricer. 1	Pricer. 2	Pricer. 3	Pricer. 4
820,43	902,55	926,06	978,72

RomboSeat to RomboTable

Includes: RomboSeat adapted with hole pattern for RomboTable.
W. 1000 H. 450 D. 650
647161-

820,43	902,55	926,06	978,72
--------	--------	--------	--------

RomboSeat to RomboTable & RomboScreen

Includes: RomboSeat adapted with hole pattern for RomboTable and RomboScreen.
W. 1000 H. 450 D. 650
647162-

820,43	902,55	926,06	978,72
--------	--------	--------	--------

ROMBOSEAT WITH WHEELS

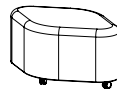

RomboSeat with wheels

Includes: RomboSeat with lockable wheels.
W. 1000 H. 475 D. 650
647165-

Pricer. 1	Pricer. 2	Pricer. 3	Pricer. 4
932,13	1014,26	1037,77	1090,43

RomboSeat with wheels to RomboTable

Includes: RomboSeat with lockable wheels, adapted with hole pattern for RomboTable.
W. 1000 H. 475 D. 650
647166-

932,13	1014,26	1037,77	1090,43
--------	---------	---------	---------

RomboSeat with wheels to RomboTable & RomboScreen

Includes: RomboSeat with lockable wheels adapted with hole pattern for RomboTable and RomboScreen.
W. 1000 H. 475 D. 650
647167-

932,13	1014,26	1037,77	1090,43
--------	---------	---------	---------

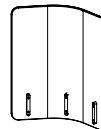

RomboScreen

Includes: RomboScreen.
W. 1000 H. 1130 D. 250
647163-

703,20	773,52	837,98	937,77
--------	--------	--------	--------

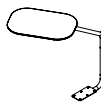

RomboTable

Includes RomboTable, tumbable. Base in metal and table top in laminate. The table is rotatable. Height from floor: 700 mm. Measure table: 450x300 mm.

647180-1	ash/white	457.45
647180-2	ash/black	457.45
647181-1	oak/white	457.45
647181-2	oak/black	457.45
647182-1	walnut/white	457.45
647182-2	walnut/black	457.45
647183-1	white/white	435.11
647183-2	white/black	435.11
647184-1	black/white	435.11
647184-2	black/black	435.11

Important information:

RomboSeat is made of: MDF, pinewood, foam seat (plastic).

RomboScreen is made of: Plywood, textile, laminate.

RomboTable is made of: Metal, MDF, laminate.

The wheels are always black, lockable.

Prices apply to colours on page 6-16. Textiles that can be selected:

Pricer. 1: Omega, Pearl, Event Screen +, Mica, Slope, Tonal
Pricer. 2: Houston Reflect, Lido, Rivet, Kaiman, Noble lux, Era
Pricer. 3: Bond, Blazer, Synergy, Ally
Pricer. 4: Remix 3, Illusion

Order procedure for RomboSeat:

1: Choose textile for RomboSeat .

Ex: 647167-517-206. Colour textile = colour on seam.

2: Choose textile for RomboScreen .

Ex: 647163-519-206. Colour textile = colour on seam.

3: Choose colour for RomboTable Ex: 647180-2.

Tip!

Feel free to order cushions for better sitting comfort.

CUSHION

Cushion square

Unlaminated. Zip hidden. Inner cushion made of synthetic fiber.

657111- W. 440 H. 180 D. 440

54,36

Cushion rectangle

Unlaminated. Zip hidden. Inner cushion made of synthetic fiber.

657101- W. 760 H. 180 D. 380

68,19



ROMBOSEAT WITH SOCKET

Romboseat is also available equipped with electricity.
Max Power Grommet is put into the seat for easy charging.



ROMBOBACKREST

Backrest is a custom-made cushion for Romboseat for better seating comfort. Match with the sofa's textile or choose a different color scale.

ROMBOSEAT WITH SOCKET

Romboseat equipped with Max Power Grommet 721503, 1 extension, USB A+C. Other equipment can be ordered as special. 1.5 meter cable included.

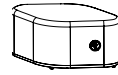

Romboseat incl. Max Power Grommet

Including: RomboSeat.

W. 1000 H. 450 D. 650	Pricer. 1	Pricer. 2	Pricer. 3	Pricer. 4
647187- white	956,91	1052,66	1084,57	1127,13
647188- black	956,91	1052,66	1084,57	1127,13

RomboSeat for RomboTable incl. Max Power Grommet

Includes: RomboSeat adapted with hole pattern for RomboTable.

W. 1000 H. 450 D. 650

647189- white	956,91	1052,66	1084,57	1127,13
647190- black	956,91	1052,66	1084,57	1127,13

RomboSeat for RomboTable & RomboScreen incl. Max Power Grommet

Includes: RomboSeat adapted with hole pattern for RomboTable and

RomboScreen. W. 1000 H. 450 D. 650

647191- white	956,91	1052,66	1084,57	1127,13
647192- black	956,91	1052,66	1084,57	1127,13

RomboSeat with wheel incl. Max Power Grommet

Includes: RomboSeat with lockable wheels. W. 1000 H. 475 D. 650

647193- white	1095,21	1180,32	1201,60	1244,15
647194- black	1095,21	1180,32	1201,60	1244,15

RomboSeat with wheel for RomboTable incl. Max Power Grommet

Includes: RomboSeat with lockable wheels, adapted with hole pattern for

RomboTable. W. 1000 H. 475 D. 650

647195- white	1095,21	1180,32	1201,60	1244,15
647196- black	1095,21	1180,32	1201,60	1244,15

RomboSeat with wheel for RomboTable & Screen incl. Max Power Grommet

Includes: RomboSeat with lockable wheels adapted with hole pattern for

RomboTable and RomboScreen. W. 1000 H. 475 D. 650

647197- white	1095,21	1180,32	1201,60	1244,15
647198- black	1095,21	1180,32	1201,60	1244,15

Important information:

RomboSeat is made of: MDF, foam.

RomboScreen is made up of: Plywood, textile, lamination.

RomboTable is made of: Metal, MDF, laminate.

Order procedure for RomboSeat with socket:

1: Choose textile for RomboSeat.

Ex: 647187-517-206. Colour textile = colour on seam.

2: Choose textile for RomboScreen.

Ex: 647187-519-206. Colour textile = colour on seam.

3: Choose colour for RomboTable.

Ex: 647180-2.

ROMBOBACKREST

RomboBackrest

Fastens with two straps around the screen on a RomboScreen.

Material: Molded wooden back with foam and foam laminated textile.

W. 705 H. 300 D. 150

647164-	276,06	286,70	350,53	403,72
---------	--------	--------	--------	--------

HOW TO ORDER ROMBOBACKREST:

Specify the article number as follow:

Backrest - textile colour (seam as textile colour).

Prices apply to colours on page 6-16. Textiles that can be selected:

Pricer. 1: Omega, Pearl, Event Screen +, Mica, Slope, Tonal

Pricer. 2: Houston Reflect, Lido, Rivet, Kaiman, Noble lux, Era

Pricer. 3: Bond, Blazer, Synergy, Ally

Pricer. 4: Remix 3, Illusion



PIECE OF CAKE

A triangle formed seating furniture that creates a circle when 6 pieces are combined. Available in two different seat heights, both of which are adapted to the Sit Around table. Dress in any soft seating textile from our standard range.



PIECE OF CAKE

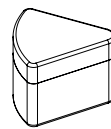

Big piece of cake

Including: 1 piece of cake.
W. 762 H. 500 D. 725

647145-

Pricer. 1	Pricer. 2	Pricer. 3	Pricer. 4
541,28	578,30	627,55	701,38

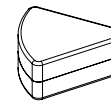

Small piece of cake

Including: 1 piece of cake.
W. 762 H. 300 D. 725

647140-

405,85	442,77	516,60	565,85
--------	--------	--------	--------

Triangle shaped seating, 6 pcs make a circle. Made of foam, dressed in textile with artificial leather underneath.

Prices apply to colours on page 6-16. Textiles that can be selected:

Pricer. 1: Omega, Pearl, Event Screen +, Mica, Slope, Tonal

Pricer. 2: Houston Reflect, Lido, Rivet, Kaiman, Noble lux, Era

Pricer. 3: Bond, Blazer, Synergy, Ally

Pricer. 4: Remix 3, Illusion

Specify the article number as follow:

Piece of cake - Colour of textile (seam as textile colour).

SIT AROUND

Round table in 2 different heights, 500 and 730 mm. The tables are delivered with a round table top in optional laminate and with a lacquered base in black or white. Choose laminate in black, ash, white, oak, or walnut. Associated seating furniture shaped like pieces of cake to place around the table.



Sit Around 730 mm

Tabletop in laminate. Base in lacquered metal.

H. 730 Ø 700

891079-1	black/white	492.02
891079-2	black/black	492.02
891080-1	ash/white	492.02
891080-2	ash/black	492.02
891081-1	white/white	492.02
891081-2	white/black	492.02
891082-1	oak/white	492.02
891082-2	oak/black	492.02
891083-1	walnut/white	492.02
891083-2	walnut/black	492.02

Also available in height 500 mm.



NO POCKET TABLE

No Pocket Table

The table is available in three combinations: oak veneer with a white stand, oak veneer with a black stand and black lacquered oak veneer with a black stand.

W. 580 H. 665 D. 380

891044	oak/white	410.00
891045	oak/black	410.00
891046	black lacquered/black	410.00

No Pocket Table is, as the name explains, an updated version of the very popular Pocket Table, but without the pocket. A stylish and modern table that works as decorations just as well for laptop work. The table is easy to move and fits several spaces.



SIT AROUND

Round table in 2 different heights, 500 and 730 mm. The tables are delivered with a round table top in optional laminate and with a lacquered base in black or white. Choose laminate in black, ash, white, oak, or walnut. Associated seating furniture shaped like pieces of cake to place around the table.

Sit Around 730 mm

Tabletop in laminate. Base in lacquered metal.
H. 730 Ø 700

891079-1	black/white	492.02
891079-2	black/black	492.02
891080-1	ash/white	492.02
891080-2	ash/black	492.02
891081-1	white/white	492.02
891081-2	white/black	492.02
891082-1	oak/white	492.02
891082-2	oak/black	492.02
891083-1	walnut/white	492.02
891083-2	walnut/black	492.02



POCKET TABLE

Pocket Table

The table is available in three combinations: oak veneer with a white stand, oak veneer with a black stand and black lacquered oak veneer with a black stand. Pocket in artificial leather.

W. 580 H. 665 D. 380

891041	oak/white	533.09
891042	oak/black	533.09
891043	black lacquered/black	533.09



Sit Around 500 mm

Tabletop in laminate. Base in lacquered metal.
H. 500 Ø 700

891084-1	ash/white	467.34
891084-2	ash/black	467.34
891085-1	white/white	467.34
891085-2	white/black	467.34
891086-1	oak/white	467.34
891086-2	oak/black	467.34
891087-1	walnut/white	467.34
891087-2	walnut/black	467.34
891088-1	black/white	467.34
891088-2	black/black	467.34



Colour 273
(12-3)



Colour 274
(16-3)



Colour 275
(18-32)

MOTIF / JANE BY AUDEJAS

OFFICE NAP

Office Nap

Inner bag covered with the textile of your choice. The bottom is always in grey artificial leather.

640075- W. 600 H. 300 L. 1400 607,66

Specify the article number as follow:
Office Nap - textile colour - zip colour.
Not available with fishbone zip.
Seam will be similar to zipper tape.



Colour 270
(12-63)

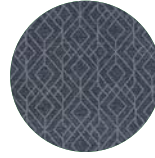

Colour 271
(16-64)



Colour 272
(18-37)

OFFICE BALLZ

Office Ballz

Delivered with a pump. Max loading 125 kg.

640055- Ø 550 347,23
640065- Ø 650 361,81

Specify the article number as follow:
Office Ballz - textile colour - zip colour.
Not available with fishbone zip.
Seam will be similar to zipper tape.

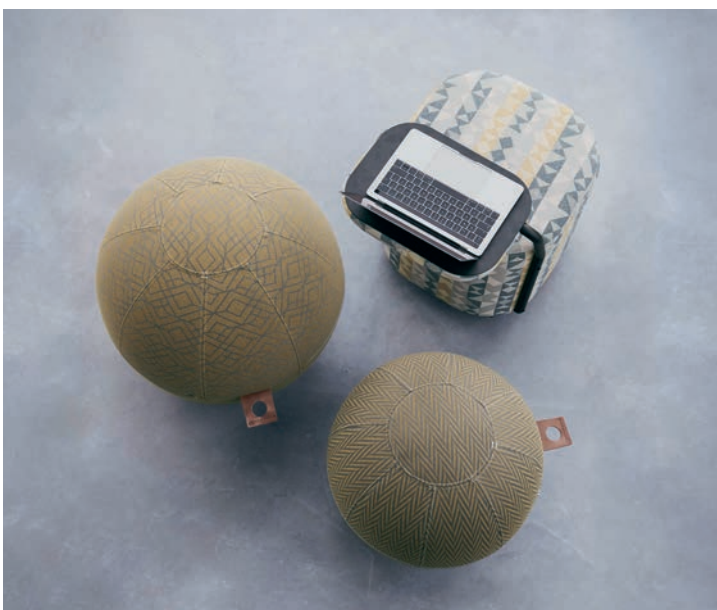

Colour 276
(12-7)



Colour 277
(16-43)



Colour 278
(18-30)

IQSEAT

iQseat

Seam is always like textile. Details/wheels can be chosen in white or black. Two lockable wheels. Max loading: 144 kg. Seat height: 500 mm.

W. 500 H. 840 D. 690

647503- white 1048,51
647504- black 1048,51

Specify the article number as follow:
iQseat - Colour of textile
(seam will be similar to textile colour).

Motif is a collection of our most popular soft seating that now can be dressed in different patterns and colours from stylish textile Jane from Audejas. We have made it easy to integrate patterns in your interior design choices. Follow a theme or mix them freely, they all look nice together. Read more about the products and their qualities in this chapter.



OFFICE BALLZ

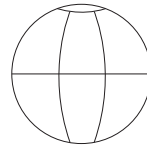

Office Ballz

Delivered with a pump.

	Pricer. 1	Pricer. 2	Pricer. 3	Pricer. 4
Office Ballz big				
640065- Ø 650	361,81	392,77	452,02	519,15
Office Ballz small				
640055- Ø 550	347,23	375,21	437,87	505,74
Office Ballz big, PVC-free				
640066- Ø 650	476,38	507,34	566,81	634,04
Office Ballz small, PVC-free				
640056- Ø 550	461,91	490,00	552,45	620,32

Prices apply to colours on page 6-16. Textiles that can be selected:

Pricer. 1: Omega, Pearl, Event Screen +, Mica, Slope, Tonal

Pricer. 2: Houston Reflect, Lido, Rivet, Kaiman, Noble lux, Era

Pricer. 3: Bond, Blazer, Synergy, Ally

Pricer. 4: Remix 3, Illusion

Specify the article number as follow:

Office Ballz - textile colour - zip colour.

Not available with fishbone zip.

Seam will be similar to zipper tape.

Also available in textile Jane/Motif, see page 134.

A fun and great seating furniture for the office that strengthens muscle groups in your back and legs and keep them active while you work. The Office Ballz is available in two sizes in a large variation of textile and zippers so it is easy to match it with other furnishings in the office. You regulate the inner ball easily with the included pump and the bottom is reinforced which makes it stable.



OFFICE BALLZ MEDLEY

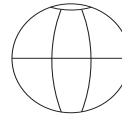

Office Ballz Medley

The leather details are always black. The zip is always silver.

640650	Ø 650	grey	361.81
640651	Ø 650	beige	361.81
640652	Ø 650	blue/grey	361.81
640653	Ø 650	green/beige	361.81

Office Ballz Medley, PVC-free

The leather details are always black. The zip is always silver.

640654	Ø 650	grey	476.38
640655	Ø 650	beige	476.38
640656	Ø 650	blue/grey	476.38
640657	Ø 650	green/beige	476.38

Office Ballz Medley is always unique thanks to the textile cover produced by left over fabric from our standard range soft seating textiles: Synergy, Remix, Blazer, Noble Lux, Slope, Mica, Event Screen, Lido, Bond and Rivet. The textile cover is available in four colour themes and is made of these textiles. Medley is built up by an inflatable pilates ball inside, textile cover and a metal plate in the bottom for stability and ergonomic benefits when used. The handle and leather protecting the metal plate are also made of left over material.



IQSEAT

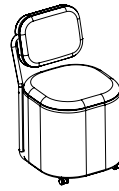

iQseat

Seam is always like textile. Details/wheels can be chosen in white or black. Two lockable wheels. Max loading: 144 kg. Seat height: 500 mm. W. 500 H. 840 D. 690

	Pricer. 1	Pricer. 2	Pricer. 3	Pricer. 4
647503- Details in white	1048,51	1205,96	1251,81	1297,66
647504- Details in black	1048,51	1205,96	1251,81	1297,66

Specify the article number as follow:

iQseat - Colour of textile (Seam will be similar to textile colour).

Also available in textile Jane/Motif, see page 134.

Prices apply to colours on page 6-16. Textiles that can be selected:
 Pricer. 1: Omega, Pearl, Event Screen +, Mica, Slope, Tonal
 Pricer. 2: Houston Reflect, Lido, Rivet, Kaiman, Noble lux, Era
 Pricer. 3: Bond, Blazer, Synergy, Ally
 Pricer. 4: Remix 3, Illusion

Flexible, comfortable, playful and stylish - a few words that describe iQseat. Lean back on this soft seat with a backrest or turn the backrest into a table when writing down your ideas. iQseats multi-functionality with wheels makes it suitable in many different spaces. Choose from white or black details - the table, wheels and pipe follow that colour choice. The design duo Henrik Kjellberg and Jon Lindström from o4i Design Studio have designed iQseat, which Götessons has developed and produced.

IQUBE

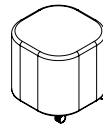

iQube

Seam always matches the fabric. Wheels in white or black of which two are lockable. Maximum load 144 kg. Seat height 500 mm. The product is delivered pre-assembled.. W. 500 H. 500 D. 500

	Pricer. 1	Pricer. 2	Pricer. 3	Pricer. 4
647510- white wheels	632,77	802,77	862,66	902,55
647511- black wheels	632,77	802,77	862,66	902,55

Specify the article number as follow:

iQube - Colour of textile (Seam will be similar to textile colour).

Also available in textile Jane/Motif, see page 134.

Prices apply to colours on page 6-16. Textiles that can be selected:
 Pricer. 1: Omega, Pearl, Event Screen +, Mica, Slope, Tonal
 Pricer. 2: Houston Reflect, Lido, Rivet, Kaiman, Noble lux, Era
 Pricer. 3: Bond, Blazer, Synergy, Ally
 Pricer. 4: Remix 3, Illusion



iQube is a playful and flexible stool on wheels. With its simple design the iQube are perfect for short office meetings or in the classroom. The wheels make the stool easy to rearrange. Choose fabric and color from our range, that suits or stands out and gives the room a little bit of color. Designed by Henrik Kjellberg and Jon Lindström from o4i Design Studio.



OFFICE NAP

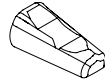

Office Nap

Inner bag covered with the textile of your choice. The bottom is always in grey artificial leather.

	Pricer. 1	Pricer. 2	Pricer. 3	Pricer. 4
640075- W. 600 H. 300 L. 1400	607,66	709,04	779,36	820,64

Office Nap without vinyl

Inner bag covered with the textile of your choice.

640076- B. 600 H. 300 L. 1400	591,49	703,19	770,21	814,89
-------------------------------	--------	--------	--------	--------

Prices apply to colours on page 6-16. Textiles that can be selected:

Pricer. 1: Omega, Pearl, Event Screen +, Mica, Slope, Tonal
 Pricer. 2: Houston Reflect, Lido, Rivet, Kaiman, Noble lux, Era
 Pricer. 3: Bond, Blazer, Synergy, Ally
 Pricer. 4: Remix 3, Illusion

Also available in textile Jane/Motif, see page 134.

Specify the article number as follow:

Office Nap - textile colour - zip colour.

Not available with fishbone zip.

Seam will be similar to zipper tape.

A soft seating furniture for the short nap to quickly get energy for the next meeting. Ideal for creative meetings in the activity-based landscape. A short nap during working hours can enhance performance and job satisfaction. Office Nap is designed and manufactured in Sweden to fit the office environment and is made of eco-friendly materials.



HANG ON

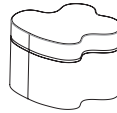

Hang On big

	Pricer. 1	Pricer. 2	Pricer. 3	Pricer. 4
647060- W. 830H. 600	564,68	629,36	662,02	782,66



Hang On medium

647080- W. 830H. 500	516,38	596,81	612,98	758,51
----------------------	--------	--------	--------	--------

Prices apply to colours on page 6-16. Textiles that can be selected:

Pricer. 1: Omega, Pearl, Event Screen +, Mica, Slope, Tonal
 Pricer. 2: Houston Reflect, Lido, Rivet, Kaiman, Noble lux, Era
 Pricer. 3: Bond, Blazer, Synergy, Ally
 Pricer. 4: Remix 3, Illusion

Specify the article number as follow:

Hang On - textile colour - zip colour.

Seam will be similar to zipper tape.

A sleek and modern seating furniture to create more diverse environments. The product is also a very good sound absorber. Hang On is available in two different heights and with a wide range of textiles and zippers.



Soft seating box with lid for storage. Fits perfectly under the desk. The SMS-box is available in a large variation of textiles and zippers so it is easy to match it with other furniture in the office.

SMS-BOX SIT - MEET - STORE



SMS-Box, black wheels				Pricer. 1	Pricer. 2	Pricer. 3	Pricer. 4
647020-	W. 370	H. 500	D. 370	314,04	329,79	392,98	487,98

SMS-Box, white wheels				Pricer. 1	Pricer. 2	Pricer. 3	Pricer. 4
647021-	W. 370	H. 500	D. 370	314,04	329,79	392,98	487,98

SMS-Box, no wheels				Pricer. 1	Pricer. 2	Pricer. 3	Pricer. 4
647050-	W. 370	H. 500	D. 370	282,34	298,83	365,11	465,00

Prices apply to colours on page 6-16. Textiles that can be selected:
 Pricer. 1: Omega, Pearl, Event Screen +, Mica, Slope, Tonal
 Pricer. 2: Houston Reflect, Lido, Rivet, Kaiman, Noble lux, Era
 Pricer. 3: Bond, Blazer, Synergy, Ally
 Pricer. 4: Remix 3, Illusion

Specify the article number as follow:
 SMS-Box - textile colour - zip colour.
 Seam will be similar to zipper tape.



SQUARE BENCH

SQUARE BENCH

Square Bench is always fitted with wheels. Can be used as free-standing or connected to other Benches.



	Pricer. 1	Pricer. 2	Pricer. 3	Pricer. 4
110930- W. 900H. 450 D. 900	1279,79	1325,96	1562,34	1836,91

Bench – the key object in three formats as a part of The Hut Lounge collection. Place a Free Bench in the entrance fitted with Table Top to meet every visitor's wish. Combine the Square Bench with any constellation to create dynamic and add an extra nice design detail.



FREE BENCH

FREE BENCH

Square Bench is always fitted with wheels. Can be used as free standing or connected to other Benches.



	Pricer. 1	Pricer. 2	Pricer. 3	Pricer. 4
110920- W. 1800 H. 450 D. 900	1779,79	1883,19	2216,81	2652,02



	Pricer. 1	Pricer. 2	Pricer. 3	Pricer. 4
110921- W. 1800 H. 450 D. 900	1963,40	2066,91	2400,53	2835,64

	Pricer. 1	Pricer. 2	Pricer. 3	Pricer. 4
110923- W. 1800 H. 450 D. 900	1963,40	2066,91	2400,53	2835,64

	Pricer. 1	Pricer. 2	Pricer. 3	Pricer. 4
110928- W. 1800 H. 450 D. 900	1963,40	2066,91	2400,53	2835,64

Note: The Hut Bench with Table Top includes 2 x 2 sockets. Table Top is a power outlet mounted in the bench. Max load 400 kg per Bench. Bench height includes mattress and wheels.

BENCH COVERS



	Pricer. 1	Pricer. 2	Pricer. 3	Pricer. 4
110950- W. 1800 H. 80 D. 900	605,74	739,57	887,13	1030,21



	Pricer. 1	Pricer. 2	Pricer. 3	Pricer. 4
110960- W. 900 H. 80 D. 900	403,51	486,91	560,96	647,45

Prices apply to colours on page 6-16. Textiles that can be selected:

Pricer. 1: Omega, Pearl, Event Screen +, Mica, Slope, Tonal
 Pricer. 2: Houston Reflect, Lido, Rivet, Kaiman, Noble lux, Era
 Pricer. 3: Bond, Blazer, Synergy, Ally
 Pricer. 4: Remix 3, Illusion





ERGONOMIC PRODUCTS, MATS AND FLOOR PROTECTION

Protect everything from top to bottom!
Ergonomical products, smart foot and wrist support that make sure you are in the right position when you work. A variety of types of removable carpets and floor coverings to prevent unnecessary wear.



YOGA MAT STANDZON

Yoga is an ergonomically designed anti-fatigue mat that is ideal for standing work. The mat has a smart handle, making it easy to hang on either wall or by your screen on the desk when it isn't being used. Fits hanging on the ScreenIT A30 hook.



Yoga mat StandzOn

Soft ergonomic mat with cork or textile-clad surface. The core is made of absorbing and silencing material polyurethane.

W. 980 H. 18 D. 520

180005	grey	128.94
180006	cork	135.11



DOT STANDZON

Dot StandzOn, a sibling to popular Yoga Mat StandzOn. The round shape nicely breaks off the classic square and rectangular shapes office furnishing often consists of. With its smart handle, the mat can easily be hung on a hook mounted on the wall, desk or a ScreenIT A30.



Anti-fatigue mat Dot StandzOn

Soft ergonomic mat in cork or textile-clad surface. The core is made of absorbing and silencing material polyurethane.

Ø 600 H. 18

180011	grey	128.94
180012	cork	135.11



Hook with screws

Hook to be mounted under the desk. Screws included.

W. 40 H. 53 D. 58

671088-1	white	14.89
671088-2	black	14.89
671088-3	silver	14.89



Wall hook for mat

W. 40 H. 55 D. 41

671076-1	white	17.34
671076-2	black	17.34
671076-3	silver	17.34



Hook for ScreenIT A30

Hook in metal to be hung over the desk screen.

W. 60 H. 101 D. 48

671098	silver	20.21
671098-1	white	20.21
671098-2	black	20.21



ANTI-FATIGUE MAT STANDZON

An ergonomically designed mat ideal for standing work. StandzOn is a soft mat produced with polyurethane core which is sound absorbing and relieving. With its smart handle, the mat can easily be hung on a hook mounted on the wall, desk or a ScreenIT A30. Easy to wipe clean with a damp cloth.

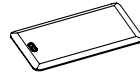

StandzOn

Ergonomic soft mat produced in polyurethane. Anti-static.

W. 820 H. 18 D. 510

180003

black

105.00

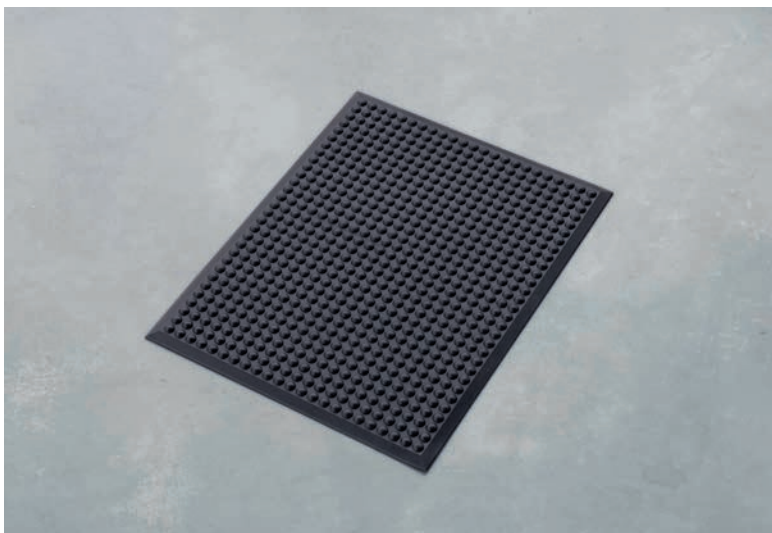

ANTI-FATIGUE MAT BUBBLE STANDZON

Ergonomic shaped mat with massagefunction, suits your standing desk. The carpet is made of polyurethane soundproofing material.



Bubble StandzOn

Ergonomic soft mat with massage function.

W. 625 H. 15 D. 450

180002

grey

139.57



FLOOR PROTECTION STANDARD

The floor cover is designed for both hard and soft floors. The protection is rectangular with rounded corners. Made of high quality transparent and black polyvinyl.



Floor Protection Standard (for plain floors)

Rectangular floor protection made of high quality polyvinyl, thickness 2,5 mm, delivery of 1 piece in cardboard packaging.

233030	L. 1000	W. 1200	transparent	96.70
233030-2	L. 1000	W. 1200	black	101.70
233040	L. 1500	W. 1200	transparent	130.21
233040-2	L. 1500	W. 1200	black	156.06
233050	L. 2000	W. 1200	transparent	156.06
233050-2	L. 2000	W. 1200	black	188.83



FLOOR PROTECTION STANDARD



Floor Protection Standard (for carpet covered floors)

Rectangular floor protection made of high quality polyvinyl. Thickness 2,5 mm. Anti-slip bottom to keep mat securely in place. Delivery of 1 piece in cardboard packaging.

233000	L. 1000	W. 1200	transparent	78.94
233000-2	L. 1000	W. 1200	black	139.04
233010	L. 1500	W. 1200	transparent	114.36
233010-2	L. 1500	W. 1200	black	191.06
233020	L. 2000	W. 1200	transparent	134.47
233020-2	L. 2000	W. 1200	black	259.15



FOOT SUPPORT

The foot support is angled and adjustable with pressure from the foot. It has a powerful construction and the upper side is covered with a durable rubber mat.

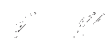

Foot support

Strong bended metal tube, 16 mm rubber covered wooden plate.
W. 550 H. 155 D. 365

125001	black	123.40
--------	-------	--------



Traditional armrest with great support and depth. Covered with strong Lycrafabric.

ARM REST SIMPLE REST



Simple Rest

Traditional arm rest. Holders can be adjusted for round desks.

Covered with Lycra fabric.

H. 25 D. 230 L. 670

122006

black

155.53



CHAIR PAD



Chair pad

Available in 10 sizes. Is pushed on the end of the chair leg.

Article number refers to 1 pcs.

14-3	Fits chair leg Ø14	H. 22	grey	1.91
16-3	Fits chair leg Ø16	H. 25	grey	1.91
18-3	Fits chair leg Ø18	H. 25	grey	1.91
19-3	Fits chair leg Ø19	H. 27	grey	1.91
20-3	Fits chair leg Ø20	H. 27	grey	1.91
22-3	Fits chair leg Ø22	H. 28	grey	1.91
25-3	Fits chair leg Ø25	H. 28	grey	2.98
28-3	Fits chair leg Ø28	H. 31	grey	2.98
32-3	Fits chair leg Ø32	H. 40	grey	5.21
40-3	Fits chair leg Ø40	H. 40	grey	5.21





ARTIFICIAL PLANTS, POTS

Decorative high quality plants for any environment. The plants are realistic, require minimal maintenance and are allergy friendly.



PLANTPANEL SLICE

Create a striking wall in the room with the help of PlantPanel Slice. Consists of molded felt and can be ordered in several different colors for more effect. Make the wall even more alive and add plants. The panel is prepared with holes for placing plants without a pot.

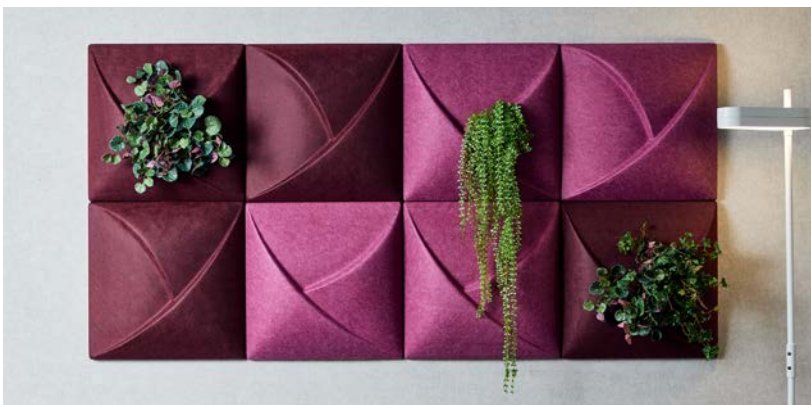

PlantPanel Slice

Molded felt from at least 55 % recycled PET. Mounted on wall with rail, suspension included. Prepared with holes for two plants.

W. 580 H. 580 D. 140

121362-1	gravel	206,91
121362-2	slate	206,91
121362-3	pine	206,91
121362-4	moss	206,91
121362-5	plum	206,91
121362-6	cherry	206,91
121362-7	cyan	206,91
121362-8	ivory	206,91
121362-9	hemp	206,91

EcoSUND for Plain and Plantpanel

Place behind Wallpanel for sound absorption. Only raw white EcoSUND.

W. 480 H. 570 D. 20

126400-1	white	20,74
----------	-------	-------

Plants that fit in the PlantPanel Slice:



Ivy without a pot
H. 550 Ø 270

160159 green 52.66



Senecio without a pot
H. 400 Ø 300

160160 green/purple 34.04



Dischidia without a pot
H. 700 Ø 150

160158 green 42.02

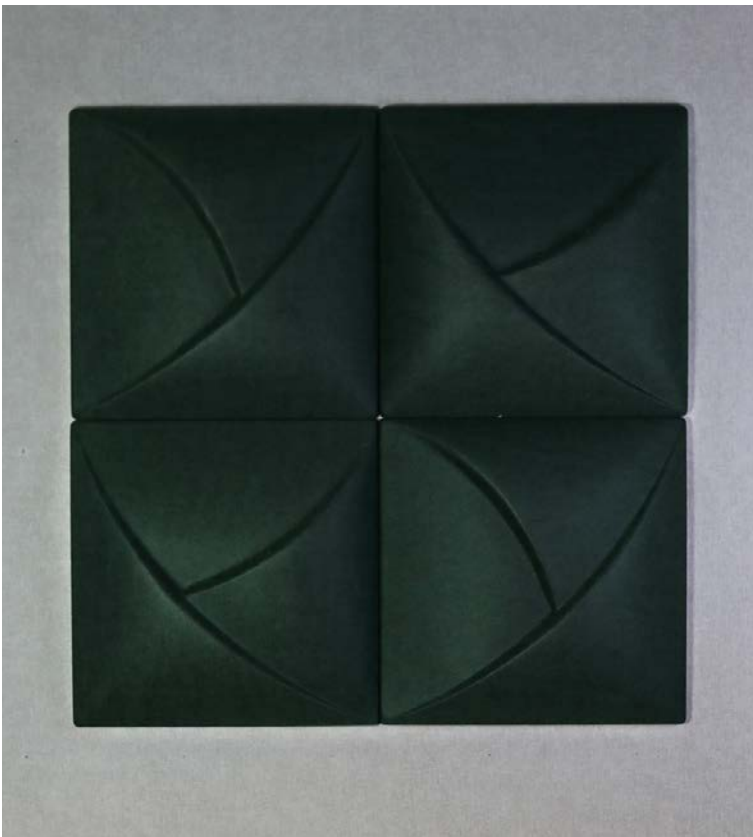

SLICEPANEL



LEAFPANEL

Create a striking wall in the room with the help of Leaf/SlicePanel. Consists of molded felt and can be ordered in several different colors for more effect.



Gravel



Slate



Pine



Moss



Plum

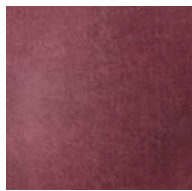

Cherry



Cyan



Ivory



Hemp

SlicePanel

Molded felt from at least 55 % recycled PET. Mounted on wall with rail, suspension included.

W. 580 H. 580 D. 140

121361-1	gravel	201,60
121361-2	slate	201,60
121361-3	pine	201,60
121361-4	moss	201,60
121361-5	plum	201,60
121361-6	cherry	201,60
121361-7	cyan	201,60
121361-8	ivory	201,60
121361-9	hemp	201,60

EcoSUND for Plain and Plantpanel

Place behind Wallpanel for sound absorption. Only raw white EcoSUND.

W. 480 H. 570 D. 20

126400-1	white	20,74
----------	-------	-------

LeafPanel

Molded felt from at least 55 % recycled PET. Mounted on wall with rail, suspension included.

W. 580 H. 580 D. 100

121360-1	gravel	201,60
121360-2	slate	201,60
121360-3	pine	201,60
121360-4	moss	201,60
121360-5	plum	201,60
121360-6	cherry	201,60
121360-7	cyan	201,60
121360-8	ivory	201,60
121360-9	hemp	201,60



PLANTPANEL

Create a unique and vibrant office with PlantPanel. A moulded panel that can be filled with artificial plants to make the room dynamic.

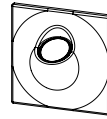

PlantPanel

Moulded felt made of at least 55% recycled PET. Mounted on the wall with included wall mount. Pot for artificial plant included, inner dimensions Ø 140, H. 130. W. 580 H. 580 D. 210

121210-1	gravel	229.04
121210-2	slate	229.04
121210-3	pine	229.04
121210-4	moss	229.04
121210-5	plum	229.04
121210-6	cherry	229.04
121210-7	cyan	229.04
121210-8	ivory	229.04
121210-9	hemp	229.04

EcoSUND for Plain and Plantpanel

Place behind Wallpanel for sound absorption. Only raw white EcoSUND. W. 480 H. 570 D. 20

126400-1	white	20.74
----------	-------	-------

Plants that fit in PlantPanel:

Fittonia 340

H. 340 Ø 100

160130	green	29.79
--------	-------	-------

Kalanchoe 250

H. 250 Ø 110

160131	green	42.13
--------	-------	-------

Peperomia 450

H. 450 Ø 100

160132	green	29.79
--------	-------	-------

Golden Pothos 1000

H. 1000 Ø 110

160145	green	76.70
--------	-------	-------

Fern 450

H. 450 Ø 112

160074	green	72.66
--------	-------	-------

Eucalyptus 500

H. 500 Ø 125

160019	green	87.23
--------	-------	-------

Ivy 450

H. 450 Ø 100

160133	green	60.43
--------	-------	-------

Ivy 850

H. 850 Ø 150

160072	green	203.83
--------	-------	--------

Palm 350

H. 350

160141	green	28.51
--------	-------	-------

To see which plants are recommended for which pots, see www.gotessons.com.



PLAINPANEL

Moulded panel with a simple design to create life in the room.

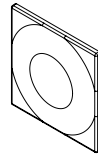
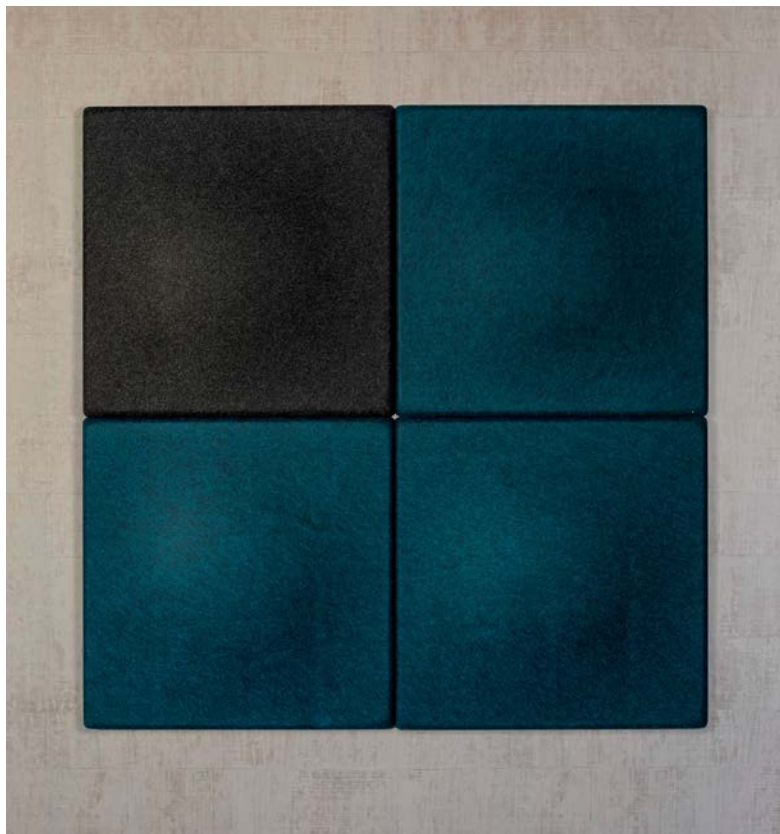

PlainPanel

Moulded felt made of at least 55% recycled PET. Mounted on the wall with included wall mount.
W. 580 H. 580 D. 60

121211-1	gravel	162.45
121211-2	slate	162.45
121211-3	pine	162.45
121211-4	moss	162.45
121211-5	plum	162.45
121211-6	cherry	162.45
121211-7	cyan	162.45
121211-8	ivory	162.45
121211-9	hemp	162.45

EcoSUND for Plain and Plantpanel

Place behind Wallpanel for sound absorption. Only raw white EcoSUND.
W. 480 H. 570 D. 20

126400-1	white	20.74
----------	-------	-------



Gravel

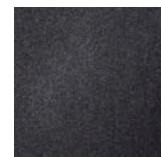

Slate

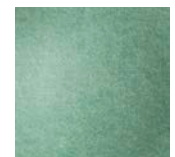

Pine



Moss



Plum

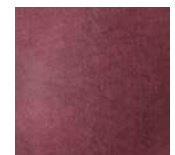

Cherry



Cyan



Ivory

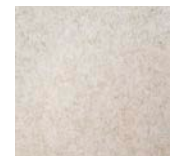

Hemp





ARTIFICIAL PLANTS

Add green details with the shape of our realistic plants to decorate the office, hotel or conference room. Natural elements create a welcoming feeling and our bigger plants act as both great interior details and perfect room dividers. The plants are just as perfect next to your desk as in an own oasis together with a group of our comfortable Office Nap, see page 104.

Note: Oil Drum and outer plant pots are not included unless otherwise specified, even if it is in the picture.

Largest diameter dimensions are specified. External dimensions are specified (pot).

ROMBOPLANTER

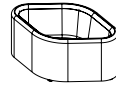

RomboPlanter 450 mm
W. 1000 H. 450 D. 650

	Pricer. 1	Pricer. 2	Pricer. 3	Pricer. 4
647175-	1063,30	1116,49	1169,68	1222,87

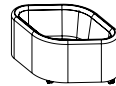

RomboPlanter 475 mm with wheels

W. 1000 H. 475 D. 650

647176- with wheels	1169,68	1222,87	1276,06	1329,26
---------------------	---------	---------	---------	---------

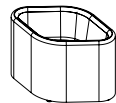

RomboPlanter 650 mm

W. 1000 H. 650 D. 650

647177-	1329,26	1382,45	1435,64	1488,83
---------	---------	---------	---------	---------



RomboPlanter 675 mm with wheels

W. 1000 H. 675 D. 650

647178- with wheels	1435,64	1488,83	1542,02	1595,21
---------------------	---------	---------	---------	---------

Important information:

RomboPlanter is made up of: MDF, covered with foam and textile.

Waterproof pot included.

The wheels are always black, lockable.

Specify the article number as follow:

RomboPlanter - Colour of textile (Seam will be similar to textile colour).

RomboPlanter is a textile-covered pot that can be filled with plants. Available in two different heights for the possibility of nice arrangements. Designed by Henrik Kjellberg and Jon Lindström from o4i Design Studio.



PLANT DIVIDER

Plant Divider is a textile dressed room divider to be combinable with plants and is a personal and flexible interior design detail. Built with 30 mm sound absorbents, it contributes to a better sound environment. Mounted with lockable wheels for easy movement.



PLANT DIVIDER 1100

Plant Divider 1100 mm

Areca Palm and Longifolia are not recommended for this product due to their sizes.

Always seam like textile.

See price ranges on page 6-16.

	Pricer. 1	Pricer. 2	Pricer. 3	Pricer. 4
161080- Plant Divider small, white wheels	1265,00	1426,60	1610,21	1811,49
161081- Plant Divider small, black wheels	1265,00	1426,60	1610,21	1811,49
161082- Plant Divider large, white wheels	1840,74	2047,45	2294,68	2576,60
161083- Plant Divider large, black wheels	1840,74	2047,45	2294,68	2576,60

Small; Out. meas: W. 820 H. 1100 D. 320 In. meas: W. 790 H. 290 D. 290

Large; Out. meas: W. 1620 H. 1100 D. 320 In. meas: W.1590 H. 290 D. 290.

Given outer measurements include wheels. Inner measurements state place for pot.

ORDER PLANT DIVIDER

Art.no - Colour of textile Example: 161080-208.

Plant Divider small-white wheels- Lido 154 Mustard.



PLANT DIVIDER 800

Plant Divider 800 mm

Areca Palm and Longifolia are not recommended for this product due to their sizes. Always seam like textile.

160083- Plant Divider small, white wheels	942,87	986,49	1088,09	1182,55
160084- Plant Divider small, black wheels	942,87	986,49	1088,09	1182,55
160085- Plant Divider large, white wheels	1378,40	1465,53	1639,79	1835,85
160086- Plant Divider large, black wheels	1378,40	1465,53	1639,79	1835,85

Small; Out. meas: W. 820 H. 800 D. 320 In. meas: W. 790 H. 290 D. 290

Large; Out. meas: W. 1620 H. 800 D. 320 In. meas: W.1590 H. 290 D. 290..

Given outer measurements include wheels. Inner measurements state place for pot.

ORDER PLANT DIVIDER

Art.no - Colour of textile Example: 161080-208.

Plant Divider small-white wheels- Lido 154 Mustard.

To see which plants are recommended for which pots, see www.gotessons.com.



PLANT DIVIDER POT

Plant Divider pot

Material: ABS-plastic. 50 litre.

160260 W. 790 H. 270 D. 290

black

115.64

Waterproof pot to Plant Divider. One pot fits to Plant Divider small, two pots is needed for the Plant Divider large.

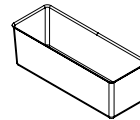

ARTIFICIAL PLANTS



H. 2600 mm

Longifolia 2600
H. 2600 Ø 195
160076 green 1435.64



H. 2100 mm

Areca Palm 2100
H. 2100 Ø 170
160000 green 405.64



H. 1800 mm

Ficus Robusta 1800
H. 1800 Ø 170
160075 green 350.96



H. 1600 mm

Olive Tree 1600
H. 1600 Ø 160
160005 green 393.51



H. 1000 mm

Olive Tree 1000
H. 1000 Ø 155
160136 green 280.00



H. 900 mm

Fikus Elastica 900
H. 900 Ø 160
160135 green 267.66



H. 900 mm

Neanthe Bella Palm 900
H. 900 Ø 110
160151 green 76.70



H. 700 mm

Yucca palm 700
H. 700 Ø 180
160152 green 98.62



H. 1800 mm

Bambu 1800
H. 1800 Ø 195
160013 green 266.28



H. 1500 mm

Bambu 1500
H. 1500 Ø 195
160012 green 222.66



H. 1500 mm

Monstera 1500
H. 1500 Ø 190
160001 green 271.28



H. 700 mm

Monstera 700
H. 700 Ø 140
160137 green 84.79



Grass Miscanthus 1500

H. 1500 Ø 150

160016 green 91.60



Grass 1300

H. 1300 Ø 130

160009 green 87.23



Grass 950

H. 950 Ø 105

160008 green 43.19



Fiddle Leaf Fig Tree 1500

H. 1500 Ø 125

160003 green 182.23



Fiddle Leaf Fig Tree 900

H. 900 Ø 125

160002 green 105.96



Eucalyptus 1100

H. 1100 Ø 210

160071 green 329.04



Eucalyptus in a pot 500

H. 500 Ø 125

160019 green 87.23

DECORATE WITH PLANTS

Our smaller plants are useful in many different ways in pots or in Plant Divider. For several plants there are already a pot included, to put directly on the table.

To make it more dynamic; mix high and low plants.

Note: Oil Drum and outer plant pots are not included unless otherwise specified, even if it is in the picture.

Largest diameter dimensions are specified. External dimensions are specified (pot).



Peace Lily 1050

H. 1050 Ø 230

160018 green 233.83



Sansiveria incl. black pot 900

H. 900 Ø 180

160015 green 191.49



Cycas Palm incl. black pot 700

H. 700 Ø 180

160014 green 281.06



Anthurium 650

H. 650 Ø 200

160140 burgundy 371.70



Calathea 550

H. 550 Ø 100

160143 green 43.40



Calathea 550

H. 550 Ø 100

160144 burgundy 43.40

To see which plants are recommended for which pots, see www.gotessons.com.



H. 650 mm

Orchid Phalaenopsis incl. glass pot 650
H. 650 Ø 150
160010 white 166.91



H. 550 mm

Aloe Vera incl. black pot 550
H. 550 Ø 190
160007 green 136.49



H. 450 mm

Fern 450
H. 450 Ø 112
160074 green 72.66



H. 350 mm

Palm 350
H. 350 Ø 100
160141 green 28.51



H. 340 mm

Fittonia 340
H. 340 Ø 100
160130 green 29.79



H. 250 mm

Kalanchoe 250
H. 250 Ø 110
160131 green 42.13



Wood Chips brown
Wood chips are made of 100 % conifers,
coloured with iron oxide. 40 liter. W. 8 kg.
160065 nature 34.89



Decor stone Slate
20-40 mm, 5 liter. W. 6.6 kg.
160066 grey 90.21



Leca
40 liter. W. 12 kg.
160095 nature 41.91

ARTIFICIAL PLANTS



Golden Pothos 1000
H. 1000 Ø 110
160145 green 76.70



Hoya 650
H. 650 Ø 250
160134 green 407.98



Ivy 850
H. 850 Ø 150
160072 green 203.83



Ivy 450
H. 450 Ø 100
160133 green 60.43



Peperomia 450
H. 450 Ø 100
160132 green 29.79

To see which plants are recommended for which pots, see www.gotessons.com.



L. 1900 mm

Golden Pothos garland 1900

H. 1000

160150 green 24.68



L. 1900 mm

Eucalyptus garland

L. 1900

160068 green 129.04



L. 1800 mm

Peperomia garland 1800

H. 1000

160149 green 33.40



L. 1800 mm

Ivy garland

L. 1800

160067 green 43.19



L. 1800 mm

Fittonia garland 1800

H. 1000

160146 green 50.00



L. 1700 mm

Pumila garland 1700

LH. 1000

160147 green 50.00

To see which plants are recommended for which pots, see www.gotessons.com.

POTS

Combine our stylish pots and oil drums with each other to set the right tone in your interior. Easily create a dynamic and modern oasis by combining sizes, nuances and shapes. Use as a room divider or to create a welcoming, furnished space. Place the plant in a pot or oil drum and add some mulch for an extra stylish finish. Tip: fill the pot with paper, packaging or similar to raise the plant. Then add wood chips or decor stone.



Plant pot Napoli large

Material: ceramic.

H. 590 Ø 330

160100 brown/black 260.74



Plant pot Napoli large

Material: ceramic.

H. 590 Ø 330

160103 beige 260.74

Slightly more luxurious ceramic pot in a stylish metallic colour. When the pot is fired and glazed, the surface layer can vary from time to time.



Plant pot Napoli small

Material: ceramic.

H. 550 Ø 250

160101 brown/black 126.60



Plant pot Napoli small

Material: ceramic.

H. 550 Ø 250

160104 beige 126.60

To see which plants are recommended for which pots, see www.gotessons.com.



Plant pot Palermo

Material: ceramic.
Can be combined with our amples for pots.
H. 180 Ø 180

160110	black	51.49
160111	white	51.49

Plant pot Palermo

Material: ceramic.
Can be combined with our amples for pots.
H. 180 Ø 180

160108	black	86.49
160109	white	86.49



Ample for plant pot

Fits our ceramic pots Palermo (H. 180) and Aloe Vera.
Pot not included. Material: jute.

160091	H. 1000	13.94
--------	---------	-------

To see which plants are recommended for which pots, see www.gotessons.com.



PLANT POT SQUARE

Plant Pot Milano wide

W. 790 H. 270 D. 290

160029 light grey 268.30

Plant Pot Milano high

W. 265 H. 725

160060 light grey 216.06

Plant Pot Milano low

W. 390 H. 319

160061 light grey 148.83

Plant Pot Milano wide

W. 790 H. 270 D. 290

160028 dark grey 268.30

Plant Pot Milano high

W. 265 H. 725

160050 dark grey 216.06

Plant Pot Milano low

W. 390 H. 319

160051 dark grey 148.83

Note: For Areca Palm pots Milano High and Wide are not recommended. For Longifolia pots Milano High/Low/Wide are not recommended. This is due to its height and width.

PLANT POT CIRCULAR



Plant pot Verona large

H. 595 Ø 450

160031 light grey 290.74

Plant pot Verona medium

H. 530 Ø 400

160032 light grey 193.51

Plant pot Padua small

H. 300 Ø 400

160033 light grey 118.94

Plant pot Verona large

H. 595 Ø 450

160040 dark grey 290.74

Plant pot Verona medium

H. 530 Ø 400

160041 dark grey 193.51

Plant pot Padua small

H. 300 Ø 400

160043 dark grey 118.94

Largest diameter dimensions are specified. External dimensions are specified (pot).

To see which plants are recommended for which pots, see www.gotessons.com.

OIL DRUM

As our oil drums come from an industrial environment, the products have a certain patina. This is part of the design. Cover included.



Oil drum small

H. 600 Ø 405 62 Liter.

160200

black

182.23

Oil drum medium

H. 815 Ø 480 120 Liter.

160021

black

273.72

Oil drum large

H. 865 Ø 600 216 Liter.

160020

black

289.04

Place your plants in an oil drum to add an edge to your interior design. With the lid they can conveniently be used as an extra table. As they come from an industrial environment, they have a certain patina. Combine with pots for a stylish mix of materials to create an oasis.

INSERT OIL DRUM

Material: Corrugated cardboard.

May not be exposed to moisture. Delivered in flat package.

Mounted separately.

Insert Oil drum 300

160112 H.300 Ø 370

40.11

160113 H.300 Ø 450

40.64

160114 H.300 Ø 560

41.17

Insert Oil drum 500

160115 H. 500 Ø 370

44.68

160116 H. 500 Ø 450

45.21

160117 H. 500 Ø 560

45.96

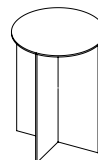

Insert made of corrugated cardboard that fits our Oil Plate and has the purpose to fill out and raise the plant. Available in three sizes and two different heights.

To see which plants are recommended for which pots, see www.gotessons.com.





LIGHTING

At Gotessons we are investing in efficient, quality lighting with modern design and very competitive pricing. We offer desk lamps with good details for optimal lighting ergonomics to your office, one also available as a floor-lamp. We also have lighting integrated in absorbers which is perfect in large rooms such as conference rooms.



Woodlight is an effective and decorative lighting in white stained ash for The Hut and Half a Hut. The intensity of the light can be adjusted by a touch dimmer. Woodlight can also be angled for maximum effect.



WOODLIGHT THE HUT COLLECTION

Wood strip in white stained ash. Grey fabric cable. Tilttable and with touch dimmer on cable. Steel brackets painted in black or white. See drawing on web for exact measurements. Adhesive label included that shows where the switch is located when the cable is hidden.

Woodlight Half a Hut

821168-2	L. 900	ash/black	382.98
821168-12	L. 900	ash/white	382.98
821168-14	L. 900	ash/grey	382.98

Woodlight The Hut

821169-2	L. 1800	ash/black	437.77
821169-12	L. 1800	ash/white	437.77
821169-14	L. 1800	ash/grey	437.77

Woodlight Open Half a Hut

821170-2	L. 900	ash/black	382.98
821170-12	L. 900	ash/white	382.98
821170-14	L. 900	ash/grey	382.98

Woodlight Open Hut

821171-2	L. 1800	ash/black	437.77
821171-12	L. 1800	ash/white	437.77
821171-14	L. 1800	ash/grey	437.77

Watt: 12 W/m
 Lumens: 1200 lm/m
 Colour temp: 3000K
 LUX: max 230
 CRI: >80
 Beam angle: 120°

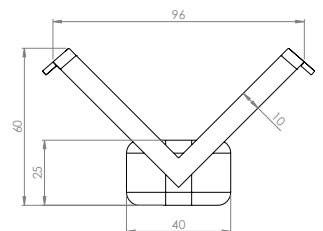

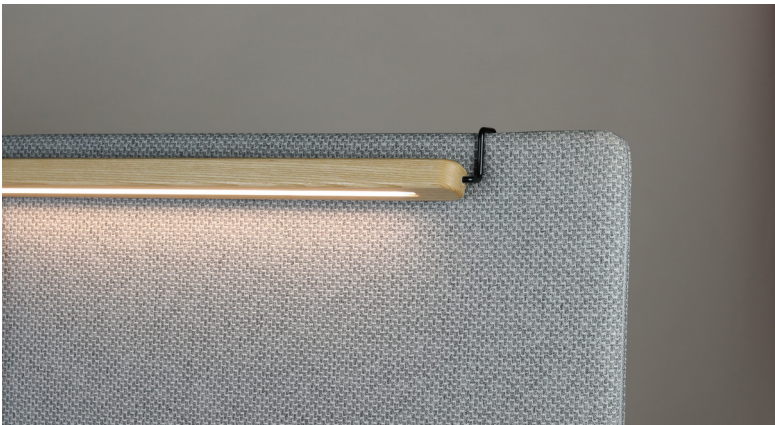

Woodlight is an effective and decorative lighting in white stained ash for A30 screens. The intensity of the light can be adjusted by a touch dimmer. Woodlight can also be angled for maximum effect.

WOODLIGHT A30

Wood strip in white stained ash. Grey fabric cable. Tilttable and with touch dimmer on cable. Steel brackets painted in black or white. See drawing on web for exact measurements. Adhesive label included that shows where the switch is located when the cable is hidden.

Woodlight A30

821164-2	L. 500	ash/black	295.32
821164-12	L. 500	ash/white	295.32
821165-2	L. 900	ash/black	328.19
821165-12	L. 900	ash/white	328.19
821166-2	L. 1300	ash/black	372.02
821166-12	L. 1300	ash/white	372.02
821167-2	L. 1800	ash/black	404.89
821167-12	L. 1800	ash/white	404.89

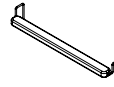

Watt: 12 W/m
Lumens: 1200 lm/m
Colour temp: 3000K
LUX: max 230
CRI: >80
Beam angle: 120°

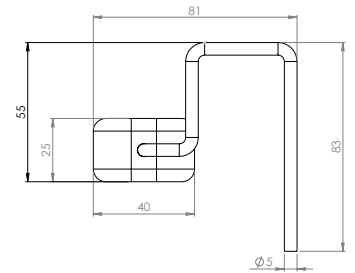

Led strip is mounted in the wooden rail, cable included.
585 mm between LED and dimmer, 3100 mm between dimmer and drive.
Europlug included.

Do not place the product in damp areas (outdoors/wet areas).

Assembly, (made by the customer on site): brackets are mounted on the sides of the product and hung on any A30 screen.



NOON

The lamp has a swivel arm with adjustable head. Cord in the same colour as the lamp. Light source not included. (GU10 light source with max. 5W required)



Noon 01

W. 348 H. 483 The base of the lamp is Ø. 162

821014	1 lamp	black	212,23
821015	1 lamp	white	212,23
821016	1 lamp	pink	212,23

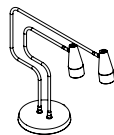

Noon 02

W. 624 H. 546 The base of the lamp is Ø. 229

821017	2 lamps	black	371,81
821018	2 lamps	white	371,81
821019	2 lamps	pink	371,81



Noon 01



Noon 02



Noon 02

Work lighting in a unique design. Noon provides an even light to work in without dazzling or creating too strong contrasts with light from, for example, a ceiling lamp or other lighting. Noon is designed as an interior detail and fits just as well as a table lamp as a bedside lamp or lighting on a bookshelf. Available in two models, with one or two arms.



FUNKIA LED LAMP

Funkia LED lamp

Adjustable in 6 different light intensities and 4 different colour temperatures. With double USB ports (5V/2A). Has an unearthed plug, 1,5 m.

821006	black	174.26
821006-1	white	174.26

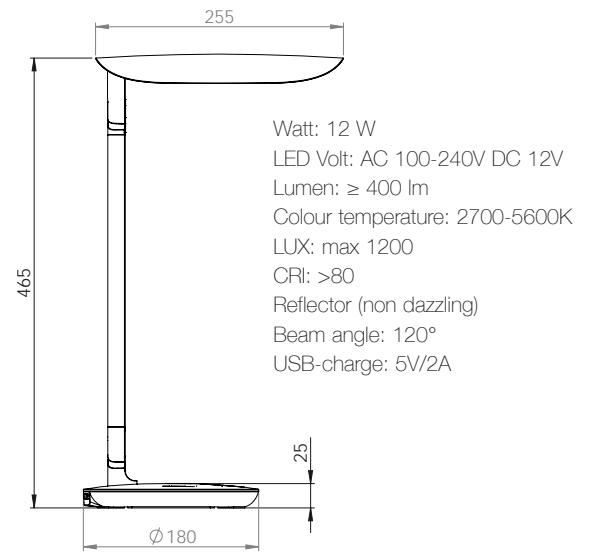

Funkia LED Lamp is a meeting between modern design and function where the matte black or white colour adds a stylish detail to the table. The joints at the top and bottom of the lamp allows you to regulate the lamp and the angle of the light after your wishes. With a simple touch, you can also adjust the light in 6 different intensities and 4 different colour temperatures.



TULIP DESK LAMP LED

Tulip Desk Lamp LED

Desk lamp with USB charger (0,7 A). Has an unearthed plug with 1,9 m cable.

821005	white/black	128.40
--------	-------------	--------

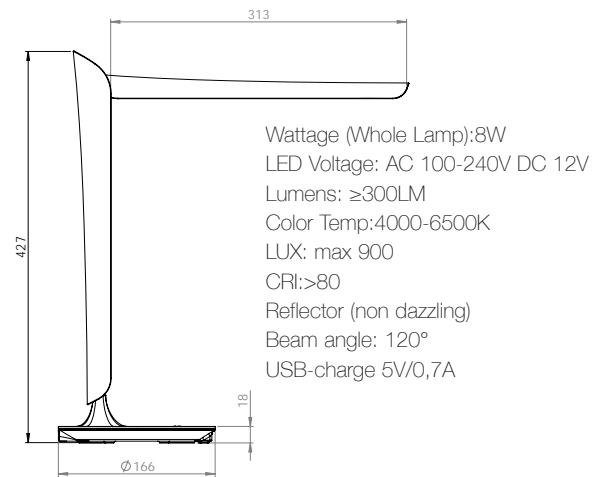

Tray for Tulip for A30

W. 172 H. 300 D. 65

637117-1 white -2 black

47.66



Tray for Tulip for Freewall

W. 172 H. 190 D. 30

671087-1 white -2 black

48.09

Very affordable, efficient and foldable desk lamp with LED lighting. Touch controls for dimming and colour temperature adjustment. USB port for charging mobile phone etc. Also available as an accessory for hanging on a toolbar rail or over our ScreenIT A30-products.



A30 LIGHT



A30 Light

Dimmable LED for mounting on A30 screen. Cable length 1,90 m with USB contact. Net adapter for wall socket included.

Watt: 4.5W.

Lumens max: 540Lm.

Colour temp: 4000K.

LUX max: 520lx at a height of 60 cm.

Lighting angle: 95 °.

637135-1

white

242.13

637135-3

silver

242.13

Lamp with screen mount for A30 screen. Add an A30 Light to your A30 screen - good lighting creates a better working environment. Hold down the on/off button to dim the light to the right brightness for you and your work tasks.



TOOLBAR LIGHT



Toolbar Light for rail

Cable length 1,90 m with USB contact. Net adapter for wall socket included.

Watt: 4,5W.

Lumen max: 540 lm.

Colour temp: 4000K.

LUX max: 520lx at a height of 60 cm.

Beam angle: 95°.

821060-1

white

253.51

821060-3

silver

253.51

Add a Toolbar Light to any of our rails.

THE LIGHTNING FLOOR LAMP

The Lightning Floor Lamp

Cable 3,5 m. Has an unearthed plug.

821050-1	See drawing	white	635.74
821050-2	See drawing	black	635.74

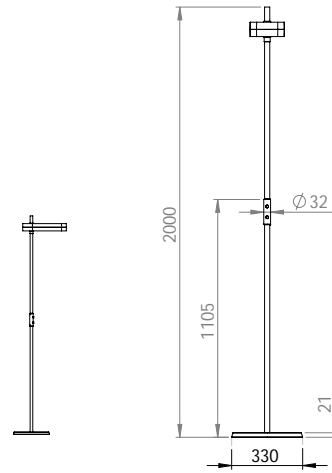
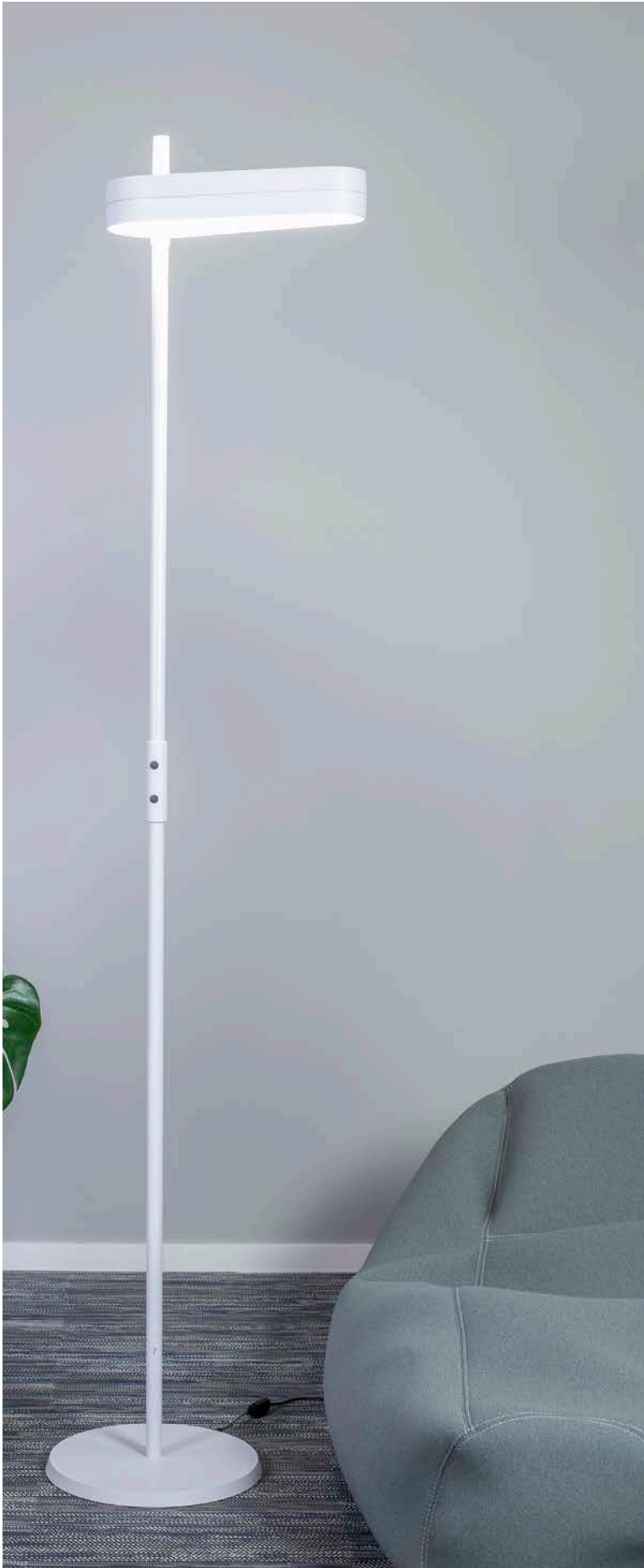

Wattage (Whole Lamp):30+30
 LED Voltage: AC 100-240V DC 24V
 Lumens: ≥4400lm
 Color Temp:3500K
 LUX: 1500/900/200 mm
 CRI:>80
 Beam angle: 120°

The Lightning is a floor lamp that suits all types of spaces. It has an uplight and a downlight function with touch buttons to adjust the light in three steps. The head is rotatable, allowing the beam to be directed in the desired direction, which improves the ergonomics. The LED module has a very long life span. With its clean expression and smart functions,



THE LIGHTNING DESK LAMP

The Lightning Desk Lamp

Can be mounted on the desk or in a Table Top with hole for a lamp. Drilled hole \varnothing 25 mm. 3,5 m cable. Has an unearthed plug.

821055-1	See drawing	white	516.91
821055-2	See drawing	black	516.91

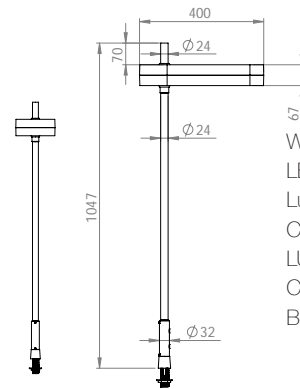

Wattage (Whole Lamp):30+30
 LED Voltage: AC 100-240V DC 24V
 Lumens: \geq 4400lm
 Color Temp:3500K
 LUX: 1500/900/200 mm
 CRI:>80
 Beam angle: 120°

The Lightning is an excellent choice. A modern LED module design with touch buttons for brightness adjustment in three different positions. LEDs have a long life span. Can be mounted directly in the desk or in a Table Top Slim. The advantage with mounting in a Table Top Slim is that it gives an easy access to an extra outlet. Also available as a floor model.



TABLE TOP SLIM, WITH HOLE FOR THE LIGHTNING



Table Top Slim, with hole for The Lightning

Table Top Slim with a hole suitable for The Lightning. 3 m extension cable included. 1 ext, 2 USB charge. Table cut out: 148x62 mm and drilled hole \varnothing 25 mm.

821161-1		white	121.06
821161-2		black	121.06

The benefit of mounting in a Table Top Slim is that you easily get access to an extra electrical outlet.



Silent Pendant Lamp is a collection lamp shades, designed to be combined with a Silent Pendant Lamp. A molded lamp with thanks to its lamp shade, spreads a wonderful light and improves the acoustics of the room. The lamp screen is available in several colors and is nice to hang next to The Hut Lamp.

LAMP SCREEN FOR SILENT PENDANT LAMP



Lamp screen for Silent Pendant Lamp

A molded lamp shade in felt. The lamp shade is available in several colours. The multi-coloured ones are stated outside/inside below. The pendant is purchased separately.

821041	Ø 594	H. 200	dark grey	125.32
821042	Ø 594	H. 200	light grey	125.32
821043	Ø 594	H. 200	green/dark grey	125.32
821044	Ø 594	H. 200	blue/light grey	125.32



LAMP FOR SILENT PENDANT LAMP

A simple pendant with a decorative, black textile cord with a copper base. A nice LED-lamp included.



Lamp for Silent Pendant Lamp

5 m cord with E27 socket.

Lumens: 540 lm. Colour temp: 2300K. Watt: 8 W.

Mounting: two wires that need to be connected to a plug, otherwise connected to an electric system by an electrician.

W. 60 H. 176

821040

copper/black

80.64



BRIGHT

A beautiful light source with a modern dimmable LED lamp and brass base. Bright works in our different The Hut constellations and is nicely combined with The Hut Lamp and Silent Pendant Lamp.

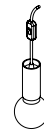

Bright

5 m black textile-covered cord with switch and E27 socket.

Lumens: max 470 lm. Color temperature: 2700 K. Watt: 4 W.

Mounting: unearthed socket.

W. 95H. 210

821025

brass/black

187.77



THE HUT LAMP

A simple and decorative ceiling pendant for a light bulb. The bracket is in copper with 5 m black textile cord and black switch. A stylish LED lamp included. The industrial lamp is part of The Hut Collection and is used to advantage in our various "houses" from that series. Read more about the collection in the chapter Room within a room.



The Hut Lamp

5 m black textile-covered cord with switch and E27 socket. 3-step click attenuation, the light effect is easily changed by clicking on the switch.

Lumens: 70 lm, 350 lm, 700 lm. Color temperature: 2100 K. Watt: 4 W.

Mounting: earthed socket.

W. 60 H. 172

821020

copper/black

142.77





MONITOR ARMS

Free up space, improve ergonomics, increase efficiency. A good monitor arm is an easy way to achieve major improvements. We have a wide selection of wall and desk arms for monitor screens in all environments – use everywhere from offices to hotels and conferences.



A stable, diverse and very affordable mechanical spring arm with ergonomic features for ideal office use. Weight span adjusted by a mechanical spring. Black cable holder with fishbone zip included. Three mounting options are included. ZAP can also be mounted on Toolbar, see chapter Toolbar.

ZAP MONITOR ARM

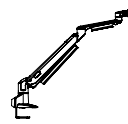

ZAP

Monitor arm that is weight span adjusted by a mechanical spring. Adjustable in all positions.

615525	Weight span 1,5-7 kg/arm	silver	304.57
615525-1	Weight span 1,5-7 kg/arm	white	304.57
615525-2	Weight span 1,5-7 kg/arm	black	304.57

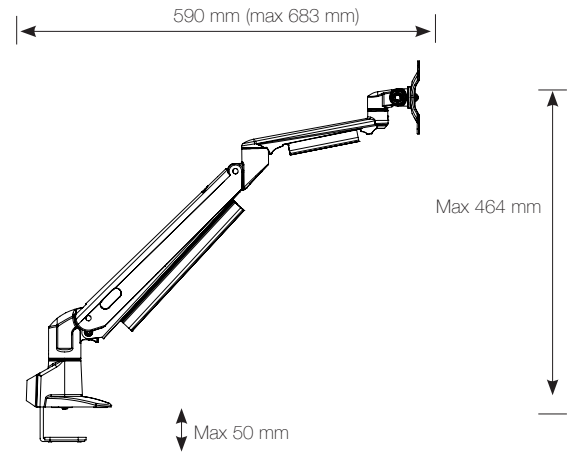

Mounting options included: Desk clamp, through desk, grommet hole 80 mm. For mount on toolbar, see chapter Toolbar.
Reach Rotation 360 degrees. Tilt 180 degrees.

VESA Monitor mount: 75x75 and 100x100.

Product weight: Net weight 3,4 kg.



A double monitor arm with stylish design

ZAP MONITOR ARM TWIN

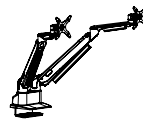

ZAP Monitorarm Twin

Monitor arm that is weight span adjusted by a mechanical spring. Adjustable in all positions. Includes 2 arms and 1 pc of twin clamp.

618525	Weight span 1,5-7 kg/arm	silver	566.38
618525-1	Weight span 1,5-7 kg/arm	white	566.38
618525-2	Weight span 1,5-7 kg/arm	black	566.38

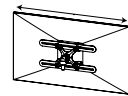

VESA-adapter ZAP Twin

VESA adapter to adjust the screens sideways. The screens will always stay poem each other without changing the screen distance.
Max weight / monitor 6 kg.

610610-2 W. 250	black	75.85
-----------------	-------	-------



V4 MONITOR ARM / V4 TWIN

V4 Monitor arm

Max weight capacity monitor arm 8 kg. Desk clamp included. Max table thickness 65 mm. Also suited for through desk mount (standard 80 mm) and Ø 10 mm. Incl. VESA attachment standard 75 and 100, rotates 360° and is tiltable.

610710	H. 400	silver	166.28
610710-1	H. 400	white	166.28
610710-2	H. 400	black	166.28

V4 TWIN

V4 Twin Complete

Max weight capacity 8 kg/arm. Desk clamp included. Max table thickness 65 mm. Also suited for through desk mount (standard 80 mm) and Ø 10 mm. Incl. VESA attachment standard 75 and 100, rotates 360° and is tiltable.

610763	H. 400	silver	290.74
610763-1	H. 400	white	290.74
610763-2	H. 400	black	290.74

V4 COMPONENTS

V4 Post

Including desk clamp. Max weight capacity 16 kg.

610762	H. 700	silver	73.09
610762-1	H. 700	white	73.09
610762-2	H. 700	black	73.09

V4 Single arm without post

Max weight capacity 8 kg.

610716	L. 420	silver	124.47
610716-1	L. 420	white	124.47
610716-2	L. 420	black	124.47

VESA-adapter plate 200x100

Adapter VESA attachment plate. Fits all arms. For larger monitors.

610700	L. 200 W. 100	silver	32.23
--------	---------------	--------	-------

VESA-adapter 200x200

Adapter VESA attachment plate for 200x200 mm. Fits all arms.

610705	L. 200 W. 200	black	54.36
--------	---------------	-------	-------

Metal plate for angled edge desks

When the clamps need stable grip with angled edge. 1 clamp included.

66500	L. 100 W. 80	silver	24.47
-------	--------------	--------	-------

Telephone/client holder for monitorarm

To be mounted to a separate arm. Suits VESA 100.

671095	W. 230 H. 240	silver	46.17
671095-1	W. 230 H. 240	white	46.17
671095-2	W. 230 H. 240	black	46.17

A competitive priced monitor arm with both clamp and desk mount option in one. Suited for through desk mount (standard 80 mm) or with desk clamp. An important detail is the possibility to adjust each arm's height individually on the post for maximal flexibility.



V4 Twin is a complete set for two screens. Do you want to mount more screens? Choose the V4 Post 700 mm with several V4 Single Arm. Max weight capacity post 16 kg and max capacity per arm 8 kg. Each arm is individually height adjustable. Suited for through desk mount (standard 80 mm) or with desk clamp.



A stable, diverse and very affordable gas spring arm with ideal ergonomic features for office use and wall mount for the home, hotel room or public spaces.

D-ZINE MONITORARM

D-Zine

The gas arm adjusts to the weight of the screen. Adjustable in all positions. Rotate 360°. Tilttable 185°. 4 graphic inlays included.

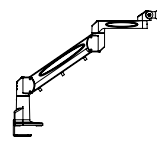

612525	Weight span 1,5-8,5 kg	silver	283.94
612525-1	Weight span 1,5-8,5 kg	white	283.94
612525-2	Weight span 1,5-8,5 kg	black	283.94
612526	Weight span 8-16 kg	silver	283.94
612526-1	Weight span 8-16 kg	white	283.94
612526-2	Weight span 8-16 kg	black	283.94

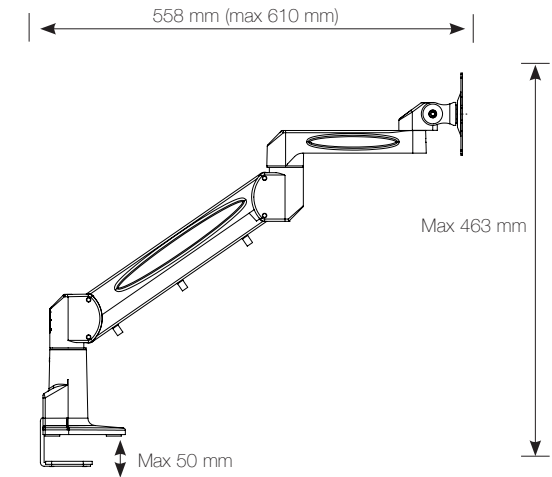

Mounting options included: Desk clamp, through desk, grommet hole 80 mm. For mount on toolbar, see the chapter Toolbar.

Monitor mount VESA: 75x75 and 100x100 is included.

Product weight: 3,4 kg.



Double bracket for monitor, VESA 75 and 100.

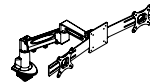

D-Zine Double Complete

D-Zine arm with Gotessons Double bracket. Maximum dimensions per screen 670 mm. Gotessons Double bracket weight 2 kg. Max weight each monitor, see below in brackets. 2 pcs VESA mount incl.

613525	Weight span 1,5-8,5 kg (3 kg)	silver	357.98
613525-1	Weight span 1,5-8,5 kg (3 kg)	white	357.98
613525-2	Weight span 1,5-8,5 kg (3 kg)	black	357.98
613526	Weight span 8-16 kg (5 kg)	silver	357.98
613526-1	Weight span 8-16 kg (5 kg)	white	357.98
613526-2	Weight span 8-16 kg (5 kg)	black	357.98

ACCESSORIES D-ZINE

Gotessons Double bracket

For mounting two screen on D-zine. Max width 670 mm/monitor. Weight 2 kg. 2 pcs VESA mount incl.

610504	L. 750	silver	74.04
610504-1	L. 750	white	74.04
610504-2	L. 750	black	74.04

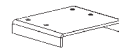

Metal plate for angled edge desks

When the clamps need stable grip with angled edge. 1 clamp included.

66500	L. 100 W. 80	silver	24.47
-------	--------------	--------	-------

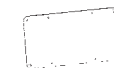

VESA-adapter plate 200x100

Adapter VESA attachment plate. Fits all arms. For larger monitors.

610700	L. 200 W. 100	silver	32.23
--------	---------------	--------	-------



VESA-adapter 200x200

Adapter VESA attachment plate for 200x200 mm. Fits all arms.

610705	L. 200 W. 200	black	54.36
--------	---------------	-------	-------



SLIM TV-MOUNT

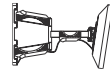

Slim TV-mount

Plasma/LCD/LED wall mount. Swivel 180° and tiltable -2°/+10°. For most 32"-60" screens. Max weight 36 kg. Arm length 46-488 mm.

610566-2

black

106.60

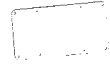

VESA-adapter plate 200x100

Adapter VESA attachment plate. Fits all arms. For larger monitors.

610700 L. 200 W. 100

silver

32.23



VESA-adapter 200x200

Adapter VESA attachment plate for 200x200 mm. Fits all arms.

610705 L. 200 W. 200

black

54.36

Flexible bracket, turnable, rotatable with integrated cabling. 46 mm from the wall.





RECYCLING CPU / LAPTOP HOLDERS CABLE HOLDERS CABLE COLLECTORS

CPU/ laptop holders not only save space at the workstation, they are also equally practical and ergonomical. A full range of products in all shapes, sizes and budgets including anti-theft solutions.

Cable clutter, not only aesthetically a nightmare, it also increases the risk of fire. Good cable management results in better hygiene and makes cleaning office spaces more efficient.



Re Turnit is a recycling module made of sheet metal that can be combined with three different tops in MDF. The tops have different cut outs to suit different recycling: circle, thin rectangle and large opening. Re Turnit can stand as a solitaire module or two opposite each other, creating a hexagon; add the plant box to one and add our artificial plants. The module can also be mounted on the wall.



With the ReTurn IT top shelf, three ReTurn IT bins are connected at the same time as a relief surface with space for plants and other decorations is created.

RE TURNIT

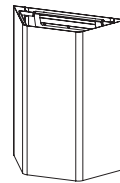

Re Turnit

Material module: sheet metal. Screws to connect modules are included.
Volume 90 liters.

610085-15	W. 602 H. 800 D. 260	grey	327.23
610085-16		green	327.23
610085-17		rust red	327.23
610085-18		white	327.23

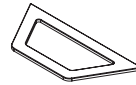

Re Turnit top

Material: coloured MDF.

610087-15	W. 592 H. 12 D. 254	grey	86.38
-----------	---------------------	------	-------

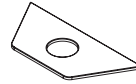

Re Turnit top cans

Material: coloured MDF.

610088-15	W. 592 H. 12 D. 254	grey	86.38
-----------	---------------------	------	-------

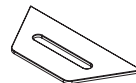

Re Turnit top paper

Material: coloured MDF.

610089-15	W. 592 H. 12 D. 254	grey	86.38
-----------	---------------------	------	-------

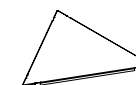

Re Turnit Top shelf

Material: painted steel. Must be combined with three pieces of Re Turnit.

610092-15	L. 605 H. 16 D. 525	grey	109.04
610092-18		white	109.04

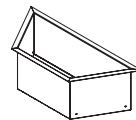

Re Turnit plant box

Material: sheet metal.

610086-15	W. 550 H. 179 D. 232	grey	92.87
-----------	----------------------	------	-------

Important info: Plants that can be planted in Re Turnit with plant box + Re Turnit top: 1 pc Fern / 2 pcs Aloe Vera / 2 pcs Fiddle Leaf Fig 900 / 5 pcs Grass 950 / 2 pcs Sansiveria / 2 pcs Ivy / 3 pcs Eucalyptus 500. For Sansiveria and Aloe Vera, Re Turnit top has to be placed over the plants.

Re Turnit waste bags

125 L.

610282	Rolls/25 units	20.00
--------	----------------	-------

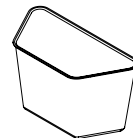

Re Turnit Damp Collector

Material: soft ABS-plastic. Waterproof.

610084	W. 524 H. 490 D. 253	black	101.70
--------	----------------------	-------	--------

Re Turnit Damp collector is a container for the recycling module Re Turnit. The container is placed at the bottom to collect moisture and liquid, must be used with a litter bag. It is easily cleaned and by using it you create a more hygienic recycling.

1 pc of each label (total 5 pcs) is included per purchase of Re Turnit. The labels are always round and only available with white text against grey background. Size: Ø 180 mm.





A rotating recycling station which takes little space underneath your desk. Built on a rotating system with removable containers for paper and other materials. Comes in silver, black or white.

SETUPIT WITH ROTATABLE POST

SetUpIT

1 rotatable metal post, 1 plastic container for paper and for other materials. Includes mounting screws.

W. 255 H. 460 D. 290

610070	black	97.98
610071	silver grey	97.98
610072	white	97.98

W. 255 H. 460 D. 440

610570*	black	130.96
610571*	silver grey	130.96
610572*	white	130.96



*with runner

SetUpIT with lid

1 rotatable metal post, 1 plastic container for paper and 1 for other materials with lid. Includes mounting screws.

W. 255 H. 460 D. 297

610073	silver grey	110.74
610074	black	110.74
610076	white	110.74

W. 255 H. 460 D. 440

610573*	silver grey	143.94
610574*	black	143.94
610576*	white	143.94

*with runner



Height distances

871003	H. 65	silver	18.09
871003-1	H. 65	white	19.79

Plastic bags for the small container

610252	Rolls/320 units	silver	7.13
--------	-----------------	--------	------

Bags for the small container

100% biodegradable.

610272	Rolls/25 units	transparent	8.72
--------	----------------	-------------	------



HALFMOON ROTATABLE PEN DRAWER

The drawer is mounted under the desk top. Contains several small sections and tape holder.



Halfmoon rotatable pen drawer

Rotatable pen drawer with sections and holder for tape. External dimension.

651060	W. 340	H. 35	D. 197	silver	24.57
651060-2	W. 340	H. 35	D. 197	black	24.57



FLOOR/WALL CABLE COLLECTOR ALUMINIUM



Floor Cable Collector aluminium

Floor canal system made of aluminium, screwed or taped to the floor. Can be ordered in any length. Contact us for price.

732080	L. 800	W. 155	H. 17	silver	75.96
732120	L. 1200	W. 155	H. 17	silver	113.83
732160	L. 1600	W. 155	H. 17	silver	151.81
732200	L. 2000	W. 155	H. 17	silver	189.89
732300	L. 3000	W. 155	H. 17	silver	284.89



FLOOR CABLE COLLECTOR TPE



Floor cable collector TPE

Price/metre, easy to cut. Order tape separately.

730000	W. 78	H. 17	grey	36.17/m
--------	-------	-------	------	---------

Tape

Self adhesive tape for floor cable collectors. Consumption 2 pcs/floor cable collector.

731000	transparent	5.00/m
--------	-------------	--------



LAPTOP BOX

Lockable box for laptop/docking station with extendable shelf and notch for cables in the back.

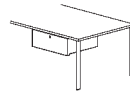

Laptop box

Anti-theft for laptop with extendable plate. External height dimensions; small 120 mm, big 166 mm. Inner dimensions.

866000-1	W. 380	H. 110	D. 420	white	255.64
866000-3	W. 380	H. 110	D. 420	silver	232.23
866010-1	W. 380	H. 60	D. 410	white	255.64
866010-3	W. 380	H. 60	D. 410	silver	232.23

Height distances for Laptop box

4 distances, mounting kit with 2 profiles of flat iron to increase stability.

850010-1	W. 60	H. 60	D. 60	white	59.15
850010-3	W. 60	H. 60	D. 60	silver	59.15



LAPTOP LOCKABLE DRAWER

Laptop lockable draw

Thin metal lockable drawer with felt inlay to be mounted under the desk for laptop no bigger than 400x300 mm.

Not suitable with Gotessons height distances.

Inner dimensions.

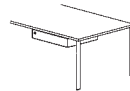

651070	W. 400	H. 64	D. 300	silver	202.87
651070-1	W. 400	H. 64	D. 300	white	202.87



PULL-OUT PEN DRAWER WITH LOCK

Thin metal pencil drawer with mat to be mounted under the desk. External dimensions.

Narrow pull-out pen drawer Mini with lock

650079-1	W. 144	H. 51	D. 265	white	112.55
650079-3	W. 144	H. 51	D. 265	silver	112.55

Narrow pull-out pen drawer with lock

650049-1	W. 144	H. 51	D. 400	white	114.15
650049-3	W. 144	H. 51	D. 400	silver	114.15

Height distances

871003	H. 65	silver	18.09
871003-1	H. 65	white	19.79

Drawers below can not be mounted on SetUpIT. Plastic insert included.

Pen drawer with lock Big

651069	W. 393	H. 55	D. 247	silver	121.60
651069-1	W. 393	H. 55	D. 247	white	121.60
651069-2	W. 393	H. 55	D. 247	black	121.60

Pen drawer with lock Small

651059	W. 319	H. 54	D. 187	silver	115.11
651059-1	W. 319	H. 54	D. 187	white	115.11
651059-2	W. 319	H. 54	D. 187	black	115.11



Twistable and rotatable holder for laptops with or without dockingstation. Takes minimum space underneath the desk, does not need runner/ slide and can be used horizontally and vertically. The vertical/horizontal tightness can be adjusted by hand.

TWISTIT



TwistIT

Twistable and rotatable holder for laptops and small CPU:s, with or without docking station. Does not need runner/slide.

Recommended max weight 5 kg, 10 kg as permanent vertical position.

W. 350 H. 350

551031		silver	172.45
551031-1		white	189.68
551031-8		black	189.68

TwistIT with runner and distances

W. 350 H. 350

551030	440 mm runner	silver	207.98
551030-1	440 mm runner	white	229.15
551030-8	440 mm runner	black	229.15

TwistIT Big

W. 380 H. 400

551033		silver	226.28
551033-1		white	248.62
551033-8		black	248.62

TwistIT Big with runner and distances

W. 380 H. 400

551032	440 mm runner	silver	260.64
551032-1	440 mm runner	white	286.91
551032-8	440 mm runner	black	286.91



Simple holder for small clients/CPU:s.

TURNIT



TurnIT Client holder

Mounted under the desk.

Computer/client is attached with 2 straps, included.

W. 125.5 H. 31 D. 220

870308-1		white	40.00
870308-3		silver	40.00
870308-8		black	40.00



Rotatable by 360° and with the ability to slide underneath your desk to the preferred position. Suits all computers on the market. Mounts on a runner.



Simple, functional and designed holder that suits most computers.

SWINGIT

SwingIT

Suits both tower and desktop models.
W. 212 D. 300

871010	with runner/distances	silver	141.60
871005	without runner	silver	105.74

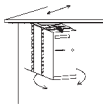

ANYWAY

Anyway

Fits tower model, width adjustable from 80-220 mm, height adjustable from 270-550 mm.

650000	without runner	silver	124.57
650000-1	without runner	white	137.23
650000-2	without runner	black	137.23
650007	with runner	silver	169.26
650007-1	with runner	white	186.28
650007-2	with runner	black	186.28
650008	for wall mount	silver	156.17

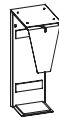

Simple model with easy and quick installation. Suits both tower and desktop models.

CPU HOLDER 1

CPU holder 1

2 flat metal profiles, 2 straps (L. 1700 mm), mounting kit.
W. 60 H. 71 D. 405

872300	tower model/desktop model	silver	58.83
872310	for thick framed desks, H. 96	silver	58.83



Only suits tower models. Slidable and rotatable. Adjustable in heights.

STAND

Stand CPU holder

W. 150 H. 330-540 D. 135

877010	with runner and distances	silver	141.60
877000	without runner	silver	105.74

Height distances

871003	H. 65
871003-1	H. 65
871003-8	H. 65



silver	18.09/par
white	19.79/par
black	19.79/par



BRINGIT LAPTOP BAG



BringIT Laptop Bag

Laptop bag in felt material with compartment on the outside, one divider in the middle on the inside and 2 compartments inside.

W. 380 H. 310 D. 110

640086

black 145.43

BringIT is a storage bag in black felt material with practical compartments for your laptop, folders and personal belongings. The bag is perfect for the activity-based office, you can easily transport all your belongings in a smooth way. Carry the computer with you in the bag to the meeting room, office or hang it at the workplace on a hook, purchased separately. Made from 100 % recyclable polyester.

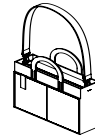

BringIT + storage bag

Laptop bag in felt material with compartment on the outside, one divider in the middle on the inside and two compartments inside. Shoulder strap and two handles. With zipper.

W. 380 H. 310 D. 110

640087

black 172.55



Hook with screws

Hook to be mounted under the desk. Screws included.

W. 40 H. 53 D. 58

671088-1

white 14.89

671088-2

black 14.89

671088-3

silver 14.89

BringIT + with both a carrying handle and a removable shoulder strap. Unlike our first Bring IT, the + model also has a zipper, which makes it extra reliable. .



Produced for a very quick and easy assembly. Saves both time and money and most importantly, a perfect cable solution at your desk.

HALFPIPE COMPLETE



Halfpipe complete

1 cable holder Halfpipe with 2 mounting ladders, 2 plastic ends, 6-way junction box (3 m), 1 network cable Cat.6 (5 m), 1 RJ12 phone cable (5 m), 1 G-clip. All cables are assembled in the Cable Collector Ø 22.

745049	L. 490	W. 170	D. 80	silver	142.77
745049-1	L. 490	W. 170	D. 80	white	157.02
745049-8	L. 490	W. 170	D. 80	black	157.02
745079	L. 790	W. 170	D. 80	silver	150.74
745079-1	L. 790	W. 170	D. 80	white	165.74
745079-8	L. 790	W. 170	D. 80	black	165.74
745115	L. 1150	W. 170	D. 80	silver	164.47
745115-1	L. 1150	W. 170	D. 80	white	181.17
745115-8	L. 1150	W. 170	D. 80	black	181.17
745150	L. 1500	W. 170	D. 80	silver	190.74
745150-1	L. 1500	W. 170	D. 80	white	209.57
745150-8	L. 1500	W. 170	D. 80	black	209.57
745170	L. 1700	W. 170	D. 80	silver	197.55
745170-1	L. 1700	W. 170	D. 80	white	217.55
745170-8	L. 1700	W. 170	D. 80	black	217.55



Halfpipe plastic end

Injection-moulded plastic. Closes of the side. Not for 770100 and 771100.

740020				silver	8.94
740020-1				white	8.94
740020-2				black	8.94

Assembly hook for Halfpipe

Makes it easier to assemble Halfpipe single handedly. One is enough for mounting several Halfpipes.

740010				black	14.15
--------	--	--	--	-------	-------



G-clips

For mounting cables under the desk. 5 clips/package.

700240-1	W. 20			white	11.38
700240-2	W. 20			black	11.38
700240-3	W. 20			silver	11.38
700242-1	W. 40			white	12.87
700242-2	W. 40			black	12.87
700242-3	W. 40			silver	12.87



Available in more combinations. Contact Gotessons for more information.

COMPLETE SET



Complete set

6-way junction box 3 m cable, 5 m net, 5 m tel. Fits all cable holders. All cables are assembled in the Cable Collector Ø 22.

700900	3 m cable, 5 m net, 5 m tele			silver	89.26
700900-1				white	89.26
700900-2				black	89.26
700905	As 700900 with 5 m cable			silver	130.21
700930	With 1x3, 1x6 sockets			silver	108.72

Complete set 1,5 m

Fits all cable holders. All cables are assembled in the Cable Collector Ø 22.

700903-1	1,5 m cable, 2 m net, 2 m tele			white	68.51
700903-2				black	68.51
700903-3				silver	68.51



Complete set with two network

6-way junction box (3 m), 2 network cable Cat.6 (5 m). All cables are assembled in the Cable Collector Ø 22.

700902	silver	-1 white -2 black			89.68
--------	--------	-------------------	--	--	-------



TURNABLE JUNCTION BOX

Can easily be mounted on or under the desk or in the Gotessons cable holder for conferences. Adjustable 360°. Protects against electrical overload and risk of overheating. Also available with desk clamp.

Turnable extensions

Fixed with screw under or above desktop. On and off button.
Length: 4 way 290 mm, 6 way 380 mm.

700420	4-way earthed, 3 m cable	white/grey	40.96
700421	6-way earthed, 3 m cable	white/grey	48.51

Turnable junction box with desk clamp

Desktop thickness max 50 mm. On and off button.
Length: 4 way 290 mm, 6 way 380 mm.

700424	4-way earthed, 3 m cable	white/grey	55.53
700425	6-way earthed, 3 m cable	white/grey	63.40



JUNCTION BOX, 3-WAYS EARTHED



Junction box earthed

700330	3-ways earthed, 1,5 m cable	white	11.38
700333	3-ways earthed, 3 m cable	white	14.79
700410	3-ways earthed, 5 m cable	white	16.06
694500	6-ways earthed, 3 m cable	white	16.06
694550	6-ways earthed, 5 m cable	white	19.79



JUNCTION BOX EARTHED WITH USB CHARGING

Junction box earthed with USB charging

721815	3-ways, 2USB, 1,5 m cable	black	26.70
--------	---------------------------	-------	-------





Available in several different lengths. The adjustable mounting attachments and low weight makes assembly quick and easy.

HALFPIPE CABLE HOLDER

Halfpipe cable holder

In cupular aluminium with adjustable turning function that allows easy cable access. Spacious, hiding large amounts of cables.

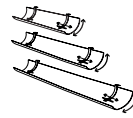

740049	L. 490	W. 170	D. 80	silver	48.19
740049-1	L. 490	W. 170	D. 80	white	53.09
740049-8	L. 490	W. 170	D. 80	black	53.09
740079	L. 790	W. 170	D. 80	silver	55.53
740079-1	L. 790	W. 170	D. 80	white	61.17
740079-8	L. 790	W. 170	D. 80	black	61.17
740115	L. 1150	W. 170	D. 80	silver	69.79
740115-1	L. 1150	W. 170	D. 80	white	76.38
740115-8	L. 1150	W. 170	D. 80	black	76.38
740150	L. 1500	W. 170	D. 80	silver	94.89
740150-1	L. 1500	W. 170	D. 80	white	104.68
740150-8	L. 1500	W. 170	D. 80	black	104.68
740170	L. 1700	W. 170	D. 80	silver	101.06
740170-1	L. 1700	W. 170	D. 80	white	111.49
740170-8	L. 1700	W. 170	D. 80	black	111.49

Cable holder Halfpipe adjustable

W. 170 D. 80 L:1000-1800 mm

740100	silver	103.72
740100-1	white	114.15
740100-8	black	114.15



Quick fit Halfpipe. No screws needed anymore. Quick release is available for all screens as mount as well as in the ScreenIT slide rail package. See page 31.

HALFPIPE CABLE TRAY ADJUSTABLE WITH KEYHOLE

Halfpipe adjustable with keyhole for desk screen

Not suitable for ScreenIT A30 P1, A30K, AT40, Standard in W:1200 mm.

W. 170 D. 80 L:1000-1800 mm

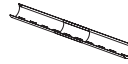

770100	silver	98,40
--------	--------	-------



Desk mount set for Halfpipe with keyhole

To be mounted with screws under the desk, 2 pcs in one pack.

642065-3	silver	66,81
----------	--------	-------

HALFPIPE ADJUSTABLE WITH KEYHOLE FOR DESKS

Halfpipe adjustable with keyhole for desks

To be mounted with screws under the desk, 2 pcs in one pack.

W. 170 D. 80 L:1000-1800 mm

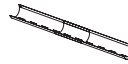

771100	silver	128.94
--------	--------	--------



Desk mount set for Halfpipe with keyhole

To be mounted with screws under the desk, 2 pcs in one pack.

642065-3	silver	66,81
----------	--------	-------



Halfpipe with keyhole mount for easier assembly.



BI-BOX

Bi-Box is a lateral openable lid and cable box in one. The lid can easily be opened in both directions. Soft close function. Add separate Power Inlay. See video at www.gotessons.com. Bi-Box is available in two sizes. The table cut out hole are the same as Gotessons Power Box.

Bi-Box small

Bi lateral openable lid and cable box in one. Table cut out 286x135 mm. W. 150 L. 300 D. 118

721000	silver	-1 white -2 black -4 copper	150.85
--------	--------	-----------------------------	--------

Bi-Box large

Bi lateral openable lid and cable box in one. Table cut out 592x135 mm. W. 150 L. 605 D. 118

721001	silver	-1 white -2 black -4 copper	272.23
--------	--------	-----------------------------	--------



POWER INLAY

Power Inlay for Bi-Box small

Easy to mount with screws, in to the bottom of the Bi-Box. Suitable for Bi-Box small. 3 m extension cable included.

721002	3 ext, 2 net	black	82.66
721003	2 ext, net, VGA, audio, HDMI	black	120.43
721007	1 ext, net, VGA, audio, HDMI, USB data	black	116.91
721008	2 ext, 2 net, USB charge	black	116.91
721010	2 ext, HDMI, USB C data	black	86.81

Power Inlay for Bi-Box large

721002	3 ext, 2 net	black	82.66
721003	2 ext, net, VGA, audio, HDMI	black	120.43
721004	4 ext, 4 net, 4 USB Data	black	173.40
721005	4 ext, net, VGA, audio, HDMI	black	165.85
721006	4 ext, 4 net, VGA, audio, HDMI, USB data	black	188.62
721007	1 ext, net, VGA, audio, HDMI, USB data	black	116.91
721008	2 ext, 2 net, USB charge	black	116.91
721009	5 ext, net, HDMI, 4 USB charge	black	205.85
721010	2 ext, HDMI, USB C data	black	86.81
721011	4 ext, HDMI, USB C data	black	108.30



CABLE HOLDER FOR CONFERENCE TABLES

Cable holder suitable for the Power Box. Foldable ends for optimal suitability.

Cable holder for Conference table

Cable holder adapted for the Power Box Single, with foldable ends for optimum suitability. Made from sheet-metal. Width bottom: 130 mm. Top 270 mm.

720000-1	L. 660	W. 130-270	D. 141	white	81.28
720000-2	L. 660	W. 130-270	D. 141	black	81.28
720000-3	L. 660	W. 130-270	D. 141	silver	74.57
720010-1	L. 290	W. 130-270	D. 141	white	56.49
720010-2	L. 290	W. 130-270	D. 141	black	56.49
720010-3	L. 290	W. 130-270	D. 141	silver	51.70

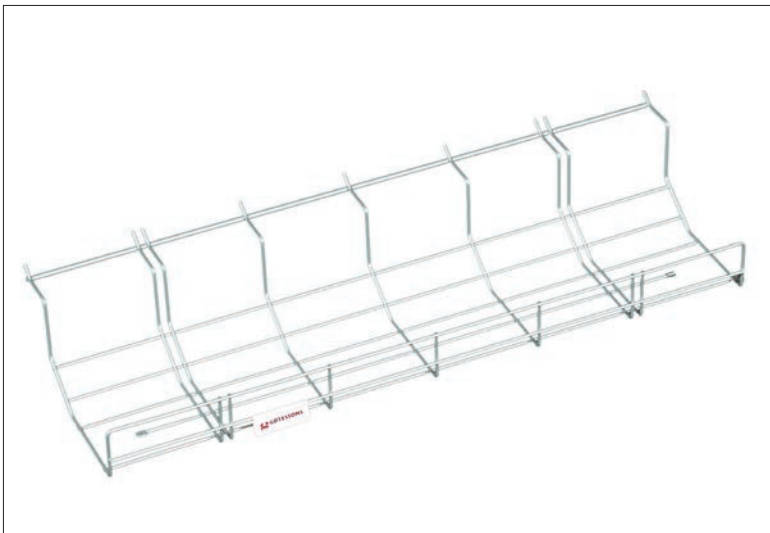

QUICK CABLE HOLDER

Designed for mounting straight underneath the desk, suitable for installation under desks with visitor seats etc. Available in two lengths. Easy installation.

Quick cable holder

687548-2	L. 480	W. 95	D. 80	black	23.51
687548-3	L. 480	W. 95	D. 80	silver	23.51
687573-2	L. 730	W. 95	D. 80	black	25.32
687573-3	L. 730	W. 95	D. 80	silver	25.32

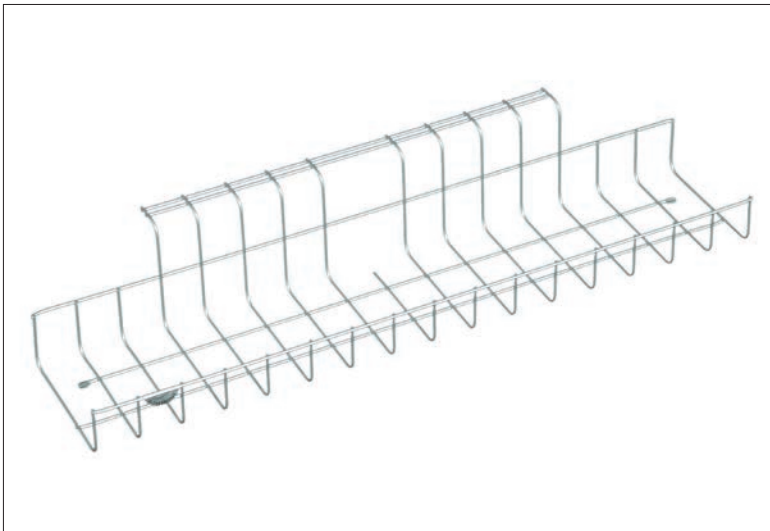

G-49 AND G-79 CABLE HOLDER

Allowing cables to be routed the shortest way to your equipment. Free passage for full cover age installation beneath the steel/wood structure of your desk.

G-49 and G-79 cable holder

621080-2	L. 490	W. 105	D. 85	black	19.57
621080-3	L. 490	W. 105	D. 85	silver	19.57
621081-2	L. 790	W. 105	D. 85	black	30.53
621081-3	L. 790	W. 105	D. 85	silver	30.53

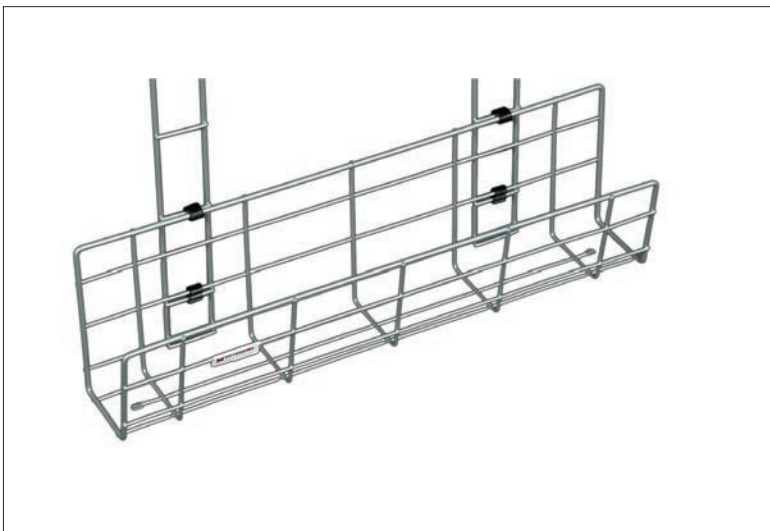

CABLECARE CABLE HOLDER

Protected cable collection holder with a flexible system allowing holders to be connected in series to any length, for high or low mounting.

CableCare Cable holder

700250-2	L. 490	W. 105	D. 145	black	24.47
700250-3	L. 490	W. 105	D. 145	silver	24.47
700280-2	L. 790	W. 105	D. 145	black	26.38
700280-3	L. 790	W. 105	D. 145	silver	26.38

Mounting ladder

700237-2	L. 360	W. 45		black	5.21
700237-3	L. 360	W. 45		silver	5.21

CableCare holder value pack

2 cable holders, 4 mounting ladders, installation kit.

700150-2	L. 490	W. 105	D. 145	black	51.06
700150-3	L. 490	W. 105	D. 145	silver	51.06
700180-2	L. 790	W. 105	D. 145	black	53.40
700180-3	L. 790	W. 105	D. 145	silver	53.40



CABLE COLLECTOR Ø 22

Flexible plastic collector for cables, to be opened and closed with a simple tool.

Cable Collector

110050	Inner dimension Ø 22	black	15.43/m
110051	Inner dimension Ø 22	silver	15.43/m
110052	Inner dimension Ø 22	white	15.43/m

Sladdslukare 20 m

110070	Inv.mått Ø 22 mm	svart	151.81
110071	Inv.mått Ø 22 mm	silver	151.81
110072	Inv.mått Ø 22 mm	vit	151.81

Tool for cable collector Ø 22

For cable collector Ø 22

110055	grey	11.17
--------	------	-------

Cable Collector value pack

2,5 m cable collector Ø 22 + tool.

110060	silver	36.49
--------	--------	-------

Cable Collector Mini

110061	Inner dimension Ø 14	black	14.36/m
--------	----------------------	-------	---------

Tool for cable collector Mini Ø 14

For cable collector Ø 14

110065	blue	11.17
--------	------	-------



CABLE COLLECTOR IN FABRIC WITH ZIP

Cable collector in fabric with zip

Cable Collector sealed with zipper.

110081	L. 3 m, black fabric, black zip	Ø 25	30.11
110083	L. 3 m, white fabric, white zip	Ø 25	30.11
110089	L. 1,5 m, black fabric, black zip	Ø 25	24.57
110090	L. 1,5 m, white fabric, white zip	Ø 25	24.57

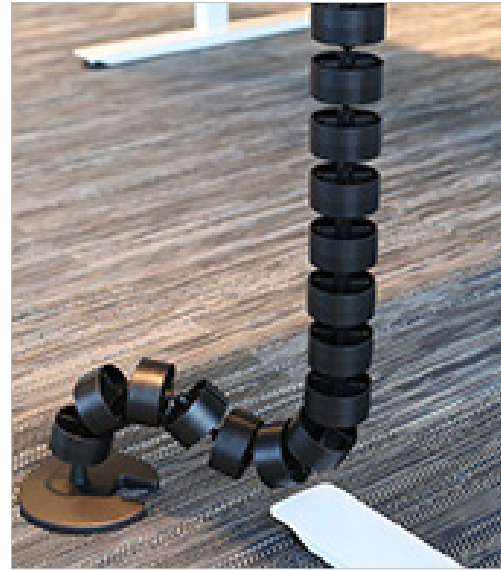

CABLE COLLECTOR

Collects cables from desk to floor, wall or ceiling. Flexible plastic construction.

Cable Collector

Delivered with mount for floor and ceiling/wall.

107558-2	L. 780 (15 sections) Ø 65	black	65.21
107558-3	L. 780 (15 sections) Ø 65	silver	65.21
107559-2	L.1230 (24 sections) Ø 65	black	82.02
107559-3	L.1230 (24 sections) Ø 65	silver	82.02
107560-2	Single section Ø 65	black	3.51
107560-3	Single section Ø 65	silver	3.51



CABLE COLLECTOR PET

Cable collector PET

Cable collector in 100% polyester. Closes itself.

110073	Ø 25	L. 25 m	white	355.74
110074	Ø 25	L. 25 m	black	355.74
110075	Ø 25	L. 25 m	silver	355.74

110085	white	110086	black	110087	silver	15.32/m
--------	-------	--------	-------	--------	--------	---------

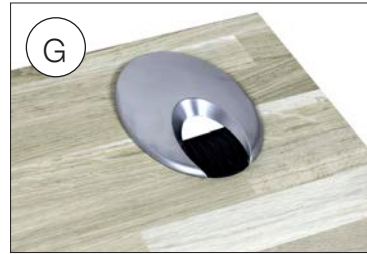

CABLE GROMMETS

A	Cable grommet plastic <i>Table cut out Ø 60.</i>	
	700303-1 white -2 black -3 silver	4.26
B	Cable grommet zinc <i>Table cut out Ø 63.</i>	
	700293 mat chrome	14.26
	700294 chrome	14.26
C	Cable grommet plastic <i>Table cut out Ø 80.</i>	
	700288-1 white -2 black -3 silver	4.26
D	Cable grommet with brush <i>Table cut out Ø 80.</i>	
	700295 silver -2 black	12.13
E	Cable grommet chrome plastic <i>Table cut out Ø 80.</i>	
	700291 chrome	9.68
F	Cable grommet zinc <i>Table cut out Ø 79</i>	
	700301-1 chrome -1 nickel -2 matte chrome -4 white	12.87
<hr/>		
	Circular saw	
	699200 Ø 64	90.96
	699300 Ø 79	90.96
	699400 Ø 80	106.91
<hr/>		

CABLE GROMMET OVAL

G	Cable grommet zinc oval <i>Table cut out Ø 80.</i>	
	700302 chrome -1 nickel -2 matte chrome	8.83
<hr/>		

We have a wide range of cable grommets. For all models, see www.gotessons.com.





ELECTRICAL ACCESSORIES

Vibrant business rooms, quiet IT rooms, creative rooms, hotel rooms or conference rooms. Regardless of the environment, we offer the appropriate solution for much needed access connections or recharging. Regardless of connections and technologies, we solve your needs.



A stylish and practical electrical outlet that can be used in a variety of environments. Powerport is spring-loaded and opens with a simple push. With two led lights on the sides that you turn on by a touch button in open position. Holding down the button changes the brightness. Dimming with memory function. With USB-A, USB-C and two power outlets.



POWERPORT

Powerport

LED lighting with touch control. Mounted in Ø 102 mm hole. Fits desk thickness up to 55 mm. Builds 365 mm under desk. 1.1 m cable. Grounded electrical outlet.

690040	2 extensions, USB A+C charge	black	339,89
690040-FR	2 extensions FR, USB A+C charge	black	339,89



BI-BOX

Bi-Box small

Bi lateral openable lid and cable box in one.

Table cut out 286x135 mm.

W. 150 L. 300 D. 118

721000 silver -1 white -2 black -4 copper

150.85

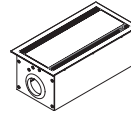

Bi-Box large

Bi lateral openable lid and cable box in one.

Table cut out 592x135 mm. W. 150 L. 605 D. 118

721001 silver -1 white -2 black -4 copper

272.23

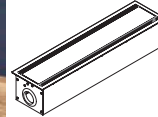

Bi-Box is a lateral openable lid and cable box in one. The lid can easily be opened in both directions. Soft close function. Add separate Power Inlay. See video at www.gotessons.com. Bi-Box is available in two sizes. The table cut out hole are the same as Gotessons Power Box.



All Power Inlay delivered with short cables. See page 211 for cable extension.

POWER INLAY

Power Inlay for Bi-Box Small

Easy to mount with screws, in to the bottom of the Bi-Box. Suitable for Bi-Box small. 3 m extension cable included.

721002 3 ext, 2 net black 82.66

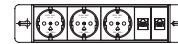

721003 2 ext, net, VGA, audio, HDMI black 120.43

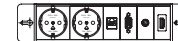

721007 1 ext, net, VGA, audio, HDMI, USB data black 116.91



721008 2 ext, 2 net, USB charge black 116.91



721010 2 ext, HDMI, USB C data black 86.81



Power Inlay for Bi-Box Small and Large

Easy to mount with screws, in to the bottom of the Bi-Box. Suitable in Bi-Box large. 3 m extension cable included.

721004 4 ext, 4 net, 4 USB data black 173.40

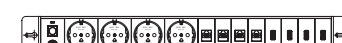

721005 4 ext, net, VGA, audio, HDMI black 165.85

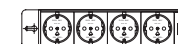

721006 4 ext, 4 net, VGA, audio, HDMI, USB data black 188.62



721009 5 ext, net, HDMI, 4 USB charge black 205.85



721011 4 ext, HDMI, USB C data black 108.30



721022 Net adapter USB A+C to Power Inlay black 56.81
Suits Power Inlay 721010+721011.

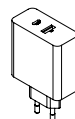

697502 Desk mount for Power Inlay black 29.47/2 pcs
To mount Power Inlay in desk top or in a existing hole.



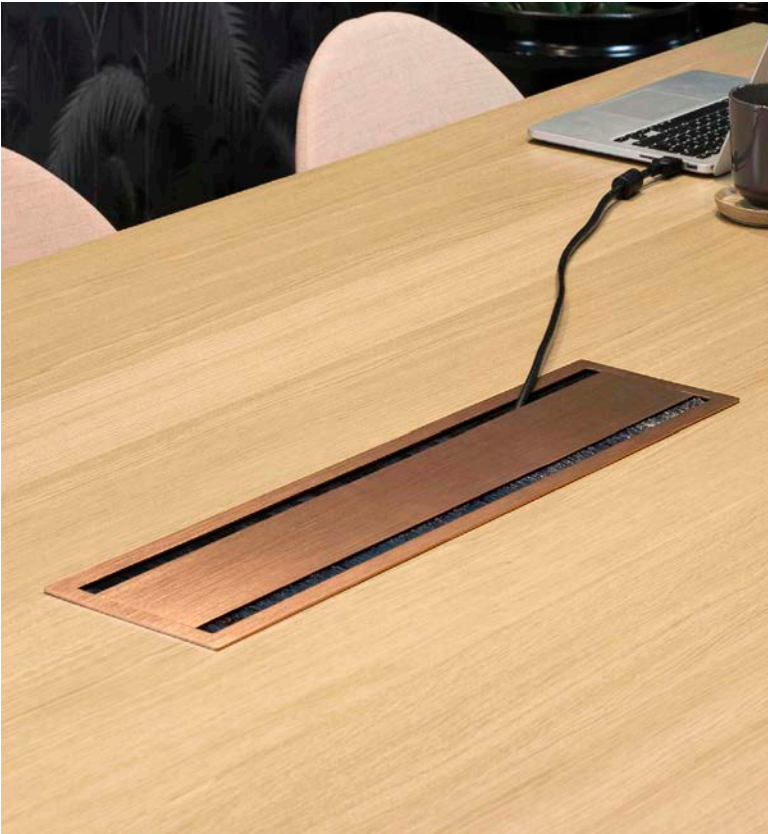

Bi-Lid is an openable lid that is easily opened both ways for easy access to e.g. cables beneath the table.

BI-LID

Bi-Lid is an openable lid that is easily opened both ways for easy access to e.g. cables beneath the table.

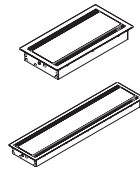

Bi-Lid Small

W. 150 L. 300 D. 42

721200 silver -1 white -2 black -4 copper

124.36

Bi-Lid Large

W. 150 L. 605 D. 42

721201 silver -1 white -2 black -4 copper

192.13

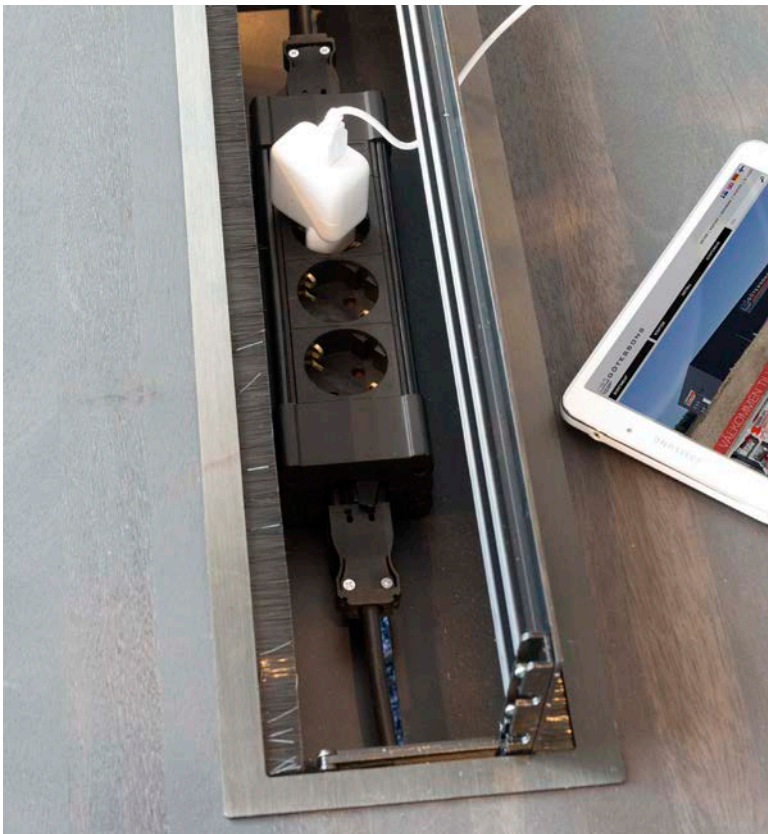

GST18 junction box with quick release connectors for a simple connection of several junction boxes. Suits ex. Bi-Boxes. Max 16 A.

GST18

Junction Box GST18

Junction box with GST18 connector for series connection.

721803 3 extension

black

27.98



721806 6 extension

black

35.21

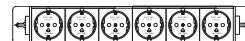

GST18 start cable

To connect GST18 junction box with socket.

721804 L. 3 m, Schuko-GST18 male

black

27.98

721805 L. 5 m, Schuko-GST18 male

black

33.72

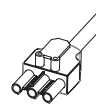

GST18 cable extension

To connect GST18 junction box with each other.

721807 L. 1 m, GST18 female - GST18 male

black

27.98

721808 L. 3 m, GST18 female - GST18 male

black

30.64



GST18 connection

1 male, 2 female

721810

black

12.66



TABLE TOP SLIM

Table Top Slim are delivered with 3 m electricity cable.



Table Top Slim 2 ext

Table cut out, 160x62 mm.

691229 silver -1 white -2 black -4 copper

90.21



Table Top Slim 1 ext. 2 USB charge

Table cut out, 160x62 mm.

691226 silver -1 white -2 black -4 copper

110.00

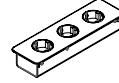

Table Top Slim 3 ext

Table cut out, 230x62 mm

691227 silver -1 white -2 black -4 copper

105.21

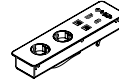

Table Top Slim 2 ext, 2 net, USB data, VGA, HDMI, audio

Table cut out, 270x62 mm. 3 m extension cable and other cables 0,2 m included.

691228 silver -1 white -2 black -4 copper

175.74



Table Top Slim 1 ext, 1 USB A, 1 USB C charge

Table cut out, 160x62 mm.

691230 silver -1 white -2 black -4 copper

110.85

Its discrete design and in-desk mounting allows for a clean desk space. Is available with different outlets and colours for easy desk level charging.



TABLE TOP SLIM, WITH HOLE FOR THE LIGHTNING

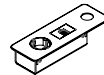

Table Top Slim, with hole for The Lightning

Table Top Slim with a hole suitable for The Lightning. 3 m extension cable included. 1 ext, 2 USB charge.

Table cut out: 148x62 mm and drilled hole \varnothing 25 mm.

821161-1 white 121.06

821161-2 black 121.06



The Lightning Desk Lamp

Can be mounted on the desk or in a Table Top with hole for a lamp. Drilled hole \varnothing 25 mm. 3,5 m cable. Has an unearthed plug.

821055-1 See drawing white 516.91

821055-2 See drawing black 516.91

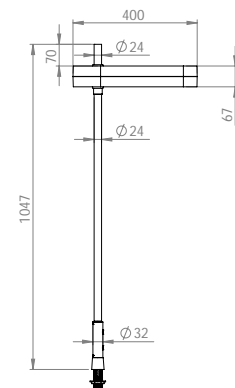



POWER BOX SINGLE

Developed to discreetly supply desks and conference tables with power and network when they are needed for charging during work and meetings. Ideal for working with laptops and charging phones.

POWER BOX SINGLE

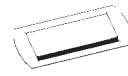

Power Box 3 ext, 2 net*

691000	silver	230.85
691000-1	white	254.15

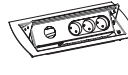

Power Box 3 ext. hole for retractable cables

691070	silver	214.89
691070-1	white	236.38

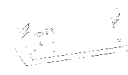

Power Box 3 ext, net, VGA, HDMI, audio

691037	silver	336.81
691037-1	white	370.21



POWER BOX EXTRA LONG

Power Box Extra Long offers more alternatives and comes as an openable top with or without sockets. Use to hide cables or connect them to charge. The image shows: 3 extensions, 1 network, VGA, HDMI, audio and 2 USB.

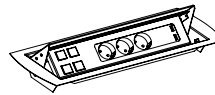

Power box extra long

Table cut out, 367x135 mm. W. 432 H. 72

Power Box extra long, 3 extensions, 2 USB charge**

691750	silver	291.91
691750-1	white	321.06

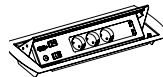

Power Box extra long, 3 extensions, 1 network, 2 USB, VGA, HDMI, audio

691760	silver	454.04
691760-1	white	499.47

Extra network connections

Network conn. Cat.6 for punched holes. Suits also as an extension of network cables (female-female).

700581	black	15.96
--------	-------	-------

Extra HDMI module

For punched holes in the Power Box.

700607	black	44.47
--------	-------	-------

Power Box is always delivered with a 1,5 m power cable.

Depth when closed: see drawing on www.gotessons.com

Hole for mounting: 286x135 mm. W. 170.



CABLE HOLDER FOR CONFERENCE TABLES

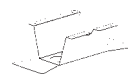

Cable holder for Conference table

Cable holder adapted for the Power Box Single, with foldable ends for optimum suitability. Made from sheet-metal.

Width bottom: 130 mm. Top 270 mm.

720010-1	L. 290	W. 130-270	D. 141	white	56.49
720010-2	L. 290	W. 130-270	D. 141	black	56.49
720010-3	L. 290	W. 130-270	D. 141	silver	51.70



Cable holder for Conference table

Cable holder adapted for the Power Box Single, with foldable ends for optimum suitability. Made from sheet-metal.

Width bottom: 130 mm. Top 270 mm.

720000-1	L. 660	W. 130-270	D. 141	white	81.28
720000-2	L. 660	W. 130-270	D. 141	black	81.28
720000-3	L. 660	W. 130-270	D. 141	silver	74.57

Only available in CE schuko.

**Possible to add 4 extra network connections.



POWER GROMMET

Fits in any Ø 80 mm grommet hole. With socket. 1,5 m. cable included. For Power Grommet with charging, a 1.5 m USB cable is also included.

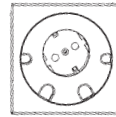

Power Grommet Twist, Ø 80 mm

1 extension, 4 cable holes

700532 black/silver -1 black /white -2 black/black -3 black/copper 41.81

Power Grommet Twist

1 FR extension, 4 cable holes

700539 black/silver -1 black /white -2 black/black -3 black/copper 48.09

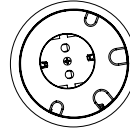

Power Grommet Twist, round Ø 80 mm

1 extension, 4 cable holes

703532 black/silver -1 black /white -2 black/black -3 black/copper 41.81

Power Grommet Twist FR round Ø 80 mm

1 FR extension, 4 cable holes

703539 black/silver -1 black /white -2 black/black -3 black/copper 49.57

POWER GROMMET TWIST

With bayonet for easier mounting. Quick and easy to install in an 80 mm diameter circular hole.

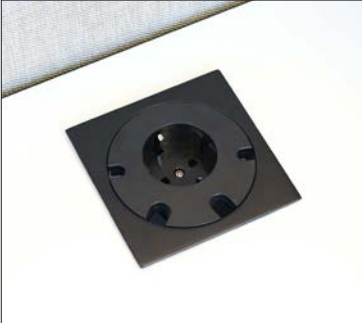

POWER GROMMET TWIST Ø 80 MM.

1 extension, 4 cable holes
Black/black.



POWER GROMMET TWIST Ø 80 MM.

1 extension, 4 cable holes.
Black/copper.



POWER GROMMET TWIST USB RUND Ø 80 MM.

1 ext, USB C charge.
Black/white.



POWER GROMMET TWIST USB RUND Ø 80 MM.

1 ext, USB C charge.
Black/black.

Fits in any Ø 80 mm grommet hole. With socket. 1,5 m. cable included.

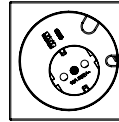

Power Grommet Twist, Ø 80 mm

1 extension, USB A+C charge

706532 black/silver -1 black /white -2 black/black -3 black/copper 85.64

Power Grommet Twist FR, Ø 80 mm

1 FR ext, USB A+C charge

706539 black/silver -1 black /white -2 black/black -3 black/copper 88,40

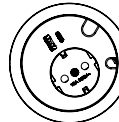

Power Grommet Twist, round Ø 80 mm

1 extension, USB A+C charge

707532 black/silver -1 black /white -2 black/black -3 black/copper 85.64

Power Grommet Twist FR, round Ø 80 mm

1 FR ext, USB A+C charge

707539 black/silver -1 black /white -2 black/black -3 black/copper 88,40

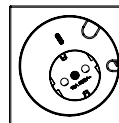

Power Grommet Twist, Ø 80 mm

1 extension, USB C charge

708532 black/silver -1 black /white -2 black/black -3 black/copper 80.21

Power Grommet Twist FR, Ø 80 mm

1 FR ext, USB C charge

708539 black/silver -1 black /white -2 black/black -3 black/copper 82,98

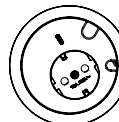

Power Grommet Twist, round Ø 80 mm

1 extension, USB C charge

709532 black/silver -1 black /white -2 black/black -3 black/copper 80.21

Power Grommet Twist FR, round Ø 80 mm

1 FR ext, USB C charge

709539 black/silver -1 black /white -2 black/black -3 black/copper 82,98

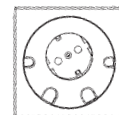

Power Grommet GST18 Ø 80 mm

700332 1 extension, 4 cable holes black/silver 50.53



Max Power Grommet is a smooth solution for cable management and direct access to electricity and USB charging ports. Available with different outlets to suit your needs.

MAX POWER GROMMET Ø 80 MM

Max Power Grommet Ø 80 mm

Fits in a Ø 80 mm hole. Cable 1,5 m.



721500-1	1 ext, 2 USB charge	white	83.09
721500-2	1 ext, 2 USB charge	black	83.09
721500-1-FR	1 ext FR, 2 USB charge	white	83.09
721500-2-FR	1 ext FR, 2 USB charge	black	83.09



721501-1	1 ext, 1 HDMI, 2 USB charge	white	102.34
721501-2	1 ext, 1 HDMI, 2 USB charge	black	102.34
721501-1-FR	1 ext FR, 1 HDMI, 2 USB charge	white	102.34
721501-2-FR	1 ext FR, 1 HDMI, 2 USB charge	black	102.34



721502-1	1 ext, HDMI, USB A+C charge	white	107.23
721502-2	1 ext, HDMI, USB A+C charge	black	107.23
721502-1-FR	1 ext FR, HDMI, USB A+C charge	white	107.23
721502-2-FR	1 ext FR, HDMI, USB A+C charge	black	107.23

HDMI-cable included, 1,5 m.



721503-1	1 ext, USB A+C charge	white	96.70
721503-2	1 ext, USB A+C charge	black	96.70
721503-1-FR	1 FR extension, USB A, USB C charge	white	96.70
721503-2-FR	1 FR extension, USB A, USB C charge	black	96.70



MINI USB GROMMET Ø 30 MM



Mini USB Grommet Ø 30 mm

Fits in a Ø 30 mm hole. 4 lids are included in black, white, silver and copper. Cable 1,5 m. D. 98.6

721400	2 USB charger	54.26
721420	1 USB A, 1 USB C charge	66.60

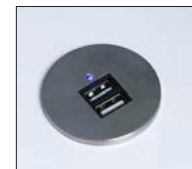

White

Silver

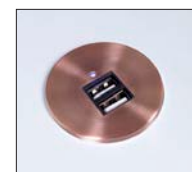

Black

Copper





G-POWER QI WIRELESS CHARGER FOR MOBILES

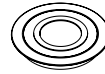

G-Power Qi

Wireless charger for mounting in hole of Ø 80 mm. USB cable included, 1 m.
721333 black 78.09

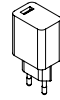

Wall adapter USB A

Adapter for wall sockets.
704535 black 17.02

Wireless charger for mobile phones compatible with Qi standard. Charging cover for mobile phones without this feature are available on the market.



OFFICE POWER CLAMP

Aluminum profile, can be used in various ways. Can be ordered with English and French/Polish sockets. Clamp and 2,88 m cable included.

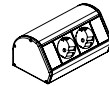

Office Power Clamp, 2 schuko sockets

697038 W. 146 H. 78 D. 91 silver 72.87

Office Power Clamp 2 UK sockets

697041 W. 160 H. 78 D. 91 silver 77.34

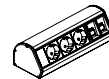

Office Power Clamp, 3 schuko sockets, 2 net

697030 W. 230 H. 78 D. 91 silver 90.21

Office Power Clamp 3 UK sockets, 2 net

697033 W. 253 H. 78 D. 91 silver 92.77

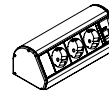

Office Power Clamp, 3 schuko sockets, one hole for retractable cable

697048 W. 200 H. 78 D. 91 silver 90.21

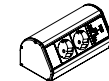

Office Power Clamp, 2 schuko sockets, 2 USB charge

697049 W. 170 H. 78 D. 91 silver 90.21

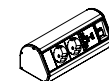

Office Power Clamp, 2 schuko sockets, 1 net, 2 USB charge

697042 W. 200 H. 78 D. 91 silver 102.13

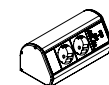

Office Powerclamp 2 schuko sockets, USB A, USB C charge

697052 W. 170 H. 78 D. 91 silver 96.06

A user friendly anodized aluminum frame including desk clamp and a 2,88 m electrical cable.



Mini-jack 3,5 mm

Analogue audio connection. For adding audio to presentations or for headset use.

Audio cable (for mini-jack) 3,5 mm

700572	L. 5 m male-female cable extension	black	14.79
700595	L. 2 m male-male	black	12.34
700596	L. 5 m male-male	black	17.55



GST18

Splits one incoming network connection into 5 or 16 useable connections.

GST18 start cable

To connect GST18 junction box with socket.

721804	L. 3 m, Schucko-GST18 male	black	27.98
721805	L. 5 m, Schucko-GST18 male	black	33.72

GST18 cable extension

To connect GST18 junction box with each other.

721807	L. 1 m, GST18 female-GST18 male	black	27.98
721808	L. 3 m, GST18 female-GST18 male	black	30.64



GST18 connection

721810	1 male, 2 female	black	12.66
--------	------------------	-------	-------



USB

To transfer data or charge. Connect memory sticks for office presentations, camera memory card readers, GPS or printers.



USB C

To transfer data or charge. Connect memory sticks for office presentations, camera memory card readers, GPS or printers.



VGA switch

To connect several CPU:s to one projector or main monitor. Switch from one CPU to another via remote control.

Video-switch (VGA)

Plug in up to 8 computers to one monitor/LCD/projector. Switch with remote control. Max resolution 2048x1536. Place in conference cable holder. CE schuko.

700588	W. 200 H. 40	black	319.04
--------	--------------	-------	--------



Network switch

Splits one incoming network connection into 5 or 16 useable connections.

Network switch (CE schuko)

16 ports, 10/100 Mbps. Exterior dimension: 200x40x142 mm. Can be placed in a cable holder for conference table.

700587		black	127.23
--------	--	-------	--------

Network switch (CE schuko)

5 ports, 10/100 Mbps. Exterior dimension: 148x28x87 mm. Can be placed in a cable holder for conference table.

700580		white	69.15
--------	--	-------	-------

Plastic clip for cables: VGA, network, audio etc.

700567		white	3.19
--------	--	-------	------

GOTESSONS 2024

For pictures, drawings, movies and other information, see www.gotessons.com.

INFORMATION

Delivery time: In stock, dispatch 2 - 5 days

Delivery 4 - 6 weeks

For larger orders or special delivery, information will be sent separately. We reserve the right of longer delivery times for some products. For special colours, please ask for a quote.

Terms of delivery: According to agreement.

Terms of payment: According to agreement. Excl. VAT.

Price adjustment: We reserve the right to adjust prices.

Transport damage: If the packaging arrives damaged, report directly to the transport company and note this on the delivery sheet when signing. We reserve the right to deny damage claims if this is not done.

Claims: Any claims should be made to Gotessons within 7 days from reception of goods, including proof of picture. Gotessons must approve returns in advance. Returns due to mistakes in the order caused by customer will be credited by 80% of the value of the invoiced product. Products must be returned in the original packaging. Freight costs will be paid by the customer. Please note, this does not apply to customized or textile products, no returns can be accepted.

Guarantee: 2 years (applies to seats with recommended fabrics.)
On Nordic Ecolabelled products, the warranty period is 5 years.



KVALITET ISO 9001:2015
och MILJÖ ISO 14001:2015

Our policy is to continuously improve our products and performance. The environment is an integral part of all our business operations, we aim to be sustainable in all meanings of the word.

acoustic facts

Swedish standard approved SS 25269. See acousticfacts.com.



Gotessons products are also available on:
pCon.planner is a professional and free 3D design software. You'll be able to create complex projects in a very simple way. No matter if you are an interior designer, a facility manager or a retailer you'll find pCon.planner an innovative and powerful work tool.
See www.easterngraphics.com

© Copyright. Products from Götessons Industri AB, Sweden. www.gotessons.com.



PRODUCT INDEX A-Z

Delivery time:

⓪ 2-5 days

Ⓢ 4-6 weeks

In stock, dispatch 2 - 5 days

Delivery 4 - 6 weeks

For larger orders or special delivery, information will be sent separately. We reserve the right of longer delivery times for some products. For special colours, please ask for a quote.

<u>Name</u>	<u>Page</u>	<u>Del.</u>	<u>Name</u>	<u>Page</u>	<u>Del.</u>	<u>Name</u>	<u>Page</u>	<u>Del.</u>
A30 Light	47	L	Laptop box	189	L	ScreenIT AT40/Above Desk	34	B
Accessories Desk	42-45	L	Leafpanel	104, 149	L	ScreenIT Plexi desk screen	35	B
Ample for pots	165	L	Leca	161	L	ScreenIT Standard desk screen	28	B
Anyway CPU Holder	191	L	Linjé 4Way Toolbar	49	L	ScreenIT Wardrobe	118	B
Backrest	65	B	Lod lamella curtain	101	B	Scribble collection	72-73	B+L
Benches	139	B	Look	44,123	L	SetUpIT	187	L
Bi-Box	196, 203	L	Metal plate for reversed desk edge	181	L	Sign	118	L
Bi-Lid	204	L	Motif/Jane textile	134	B	Silent Express desk screen	38	L
Bright lamp	177	L	Mount	22-25	L	Silent Pendant Lamp	176	L
BringIT	122, 192	L	Moving Wall	120-121	B	Simple Rest	145	L
Bubble - mat	143	L	Nivå tak ceiling absorbent	98	B	Sit Around	133	B
Cable Care cable holder	197	L	Nivå wall absorbent	112	B	Sketch writing board	75-77	B
Cable Collector	198	L	No Pocket Table	133	L	Sketch 'n Pin	74	B
Cable Grommets	199	L	Noon lamp	170	L	Skiffer	161	L
Cable holder for conf. Table	195	L	Off The Grid	96, 115	L	Sky	86-87	B
Cables	210-211	L	Office Ballz	135	B	Slicepanel	104, 149	L
Chair pad	145	L	Office Nap	137	B	Slim TV mount	183	L
Circle saw for cable grommet	199	L	Office Power Clamp	209	L	SMS-Box	138	B
Cobogo	90-91	L	Peak desk screen booth	36	B	Sofa Silent Group	66	B
Collage wall/notice board	81, 114	B	Pen tray Halfmoon	188	L	Sound Off ceiling absorbent	97	B
Complete set	193	L	Pendula	84-85	B	Sound Off letters	113	B
CPU holder 1	191	L	Piece of cake	132	B	Sound Off wall absorbent	109	B
Cubism	108	L	Plant Divider	154-155	B	Stand CPU holder	191	L
Cushions	63	B	Plant/Plain-panel	150-151	L	Storyboard wall/notice board	80	B
D-Zine	182	L	PlantPanel Slice	148	L	SwingIT CPU holder	191	L
D-Zine Toolbar	49	L	Plants	156-163	L	Table Top Slim	205	L
Divido	88	B	Plexitop for screen	46	B	Tell-Us wall absorbent	113	B
Dot StandzOn	142	L	Pocket	44, 123	L	Textile box	122	L
Double bracket for arms	182	L	Pocket Table	133	L	The Hut Collection	60-67	B
Effekt wall/ceiling absorbent	99	B	Pots	164-167	L	The Hut Roof	66	B
Floor protection	144	L	Power Boxen	206	L	The Lightning	174-175	L
Floor/wall cable coll. alu+TPE	188	L	Power Grommet	207-208	L	Tiles EcoSUND	92-93	B
FoldIT/FoldIT Basic Felt	39	B	Power Inlay	196, 203	L	Time Out	60	B
Foot support	144	L	Powerport	202	B	Tipi	89	L
Freewall	48	L	Print	110-111	B	Toolbar Light	47	L
Funkia lamp	172	L	Pull-out pen drawer with lock	189	L	Tulip/Tulip Toolbar	47	L
G-49 & G-79 cable holder	197	L	Quick cable holder	197	L	TurnIT CPU holder	190	L
G-clips	193	L	Re Turnit	186	L	TwistIT	190	L
G-Power Qi	209	L	RomboPlanter	129, 153	B	V4 monitor arm	181	L
GST 18 connection	204	L	Romboseat	130-131	B	Vertikal lamellgardin	100	B
Halfpipe cable holder	207-208	L	Rombowork	128	B	VESA-adapter	181	L
Hang In There	119	L	Sandy	126-127	B	Whiteboard	80	L
Hang On	137	B	ScreenIt A30 Collect	53	B	Wood chips	161	L
Hang Over ceiling absorbent	98	B	ScreenIT A30 desk screen	29-32	B	Woodland accessories	78-79	B
Health & Care	18-21	B	ScreenIT A30 desk screen above desk	37	B	Woodland light	171	L
Honey wall absorbent	106-107	B	ScreenIT A30 desk screen booth	36	B	Woodstock wall absorbents	108	L
Hook	45, 123	L	ScreenIT A30 desk screen Sidescreen	37	B	Yoga mat	142	L
In The Grid	94-95	L	ScreenIT A30 Flexible	30	B	ZAP	180	L
iQSeat	136	B	ScreenIT A30 floor screen booth	56-57	B	ZAP Toolbar 3	49	L
iQube	136	B	ScreenIT A30 floor screen The Rising	55	B	Woodstock wall absorbents	98	L
Junction box	194	L	ScreenIT A30/A40 floor screen	52, 54	B	Yoga mat	144	L
Landscape	105	B	ScreenIT A40	32	B	ZAP	180	L
			ScreenIT A40 desk screen with rail	33	B	ZAP Toolbar 3	49	L



OFFICE | CONFERENCE | SCHOOL | HOTEL 2024

GÖTESSONS

Gotessons with head office and distribution center in Ulricehamn, develops and markets products for office, conference, school and hotel workspaces. We offer ergonomic, functional and well designed turnkey solutions to more than 40 countries using our motto "From Workplace to Creative Space".

Visit us at [gotessons.com](https://www.gotessons.com)